

### Features

- Batch process design, excellent power dissipation offers better reverse leakage current and thermal resistance.
- Low profile surface mounted application in order to optimize board space.
- Low power loss, high efficiency.
- High current capability, low forward voltage drop.
- High surge capability.
- Guardring for overvoltage protection.
- Ultra high-speed switching.
- Silicon epitaxial planar chip, metal silicon junction.
- **Moisture Sensitivity Level 1**

### Package outline

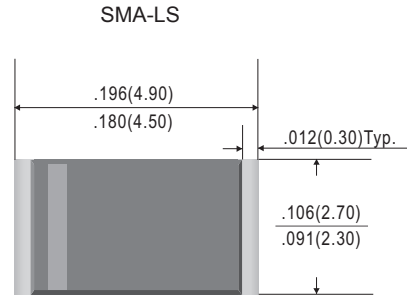

### Mechanical data

- Epoxy:UL94-V0 rated flame retardant
- Case : Molded plastic, SMA-LS
- Terminals : Solder plated, solderable per MIL-STD-750, Method 2026
- Polarity : Indicated by cathode band
- Mounting Position : Any
- Weight : Approximated 0.05 gram

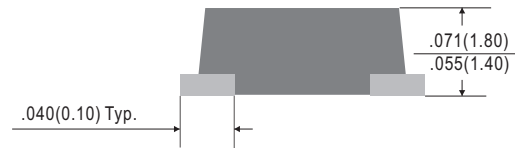

Dimensions in inches and (millimeters)

### Maximum ratings and Electrical Characteristics (AT $T_A=25^{\circ}\text{C}$ unless otherwise noted)

PARAMETER	CONDITIONS	Symbol	MIN.	TYP.	MAX.	UNIT
Forward rectified current	See Fig.2	$I_o$			1.0	A
Forward surge current	8.3ms single half sine-wave superimposed on rate load (JEDEC methode)	$I_{FSM}$			30	A
Reverse current	$V_R = V_{RRM}$ $T_J = 25^{\circ}\text{C}$	$I_R$			1.0	mA
Diode junction capacitance	f=1MHz and applied 4V DC reverse voltage	$C_j$		130		pF
Storage temperature		$T_{STG}$	-55		+150	$^{\circ}\text{C}$

SYMBOLS	$V_{RRM}^{*1}$ (V)	$V_{RMS}^{*2}$ (V)	$V_R^{*3}$ (V)	$V_F^{*4}$ (V)	Operating temperature $T_J$ ( $^{\circ}\text{C}$ )
SL12-L	20	14	20	0.38	-55 to +100
SL14-L	40	28	40	0.40	

\*1 Repetitive peak reverse voltage

\*2 RMS voltage

\*3 Continuous reverse voltage

\*4 Maximum forward voltage@ $I_F=1.0\text{A}$



### Rating and characteristic curves

FIG.1-TYPICAL FORWARD CHARACTERISTICS

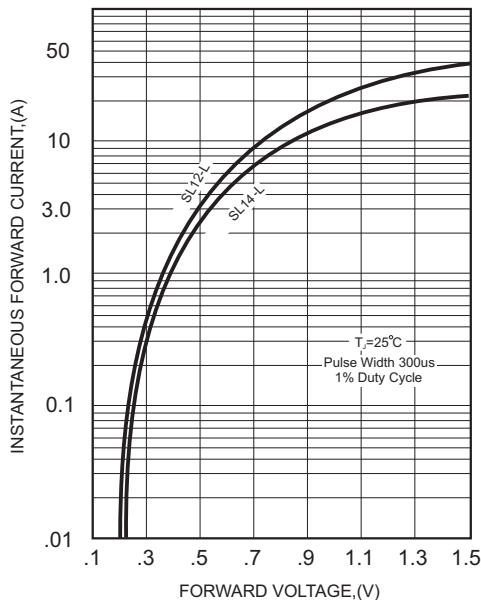

FIG.2-TYPICAL FORWARD CURRENT DERATING CURVE

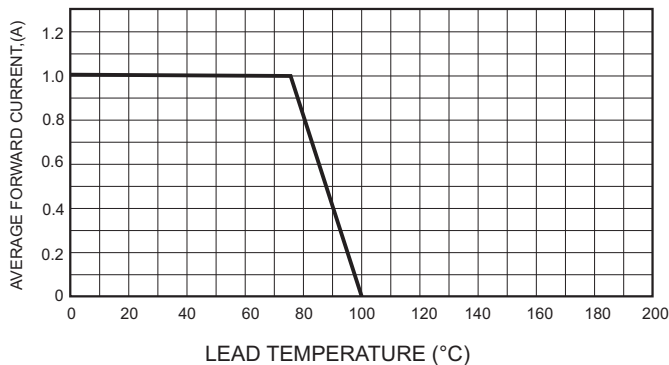

FIG.4-MAXIMUM NON-REPETITIVE FORWARD SURGE CURRENT

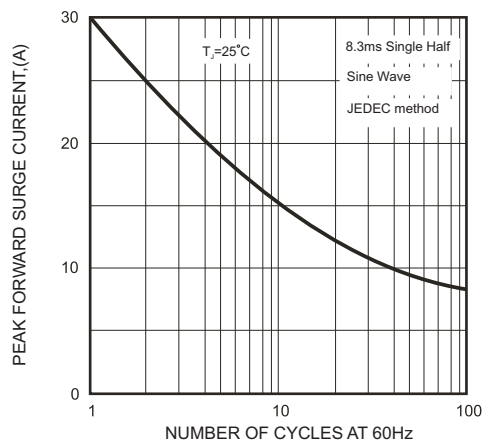

FIG.3 - TYPICAL REVERSE CHARACTERISTICS

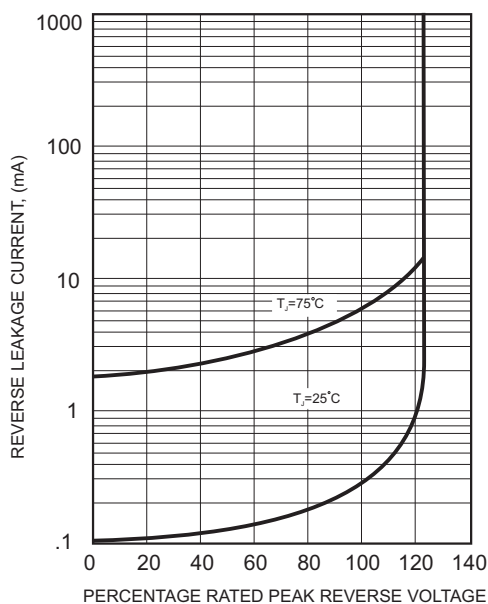
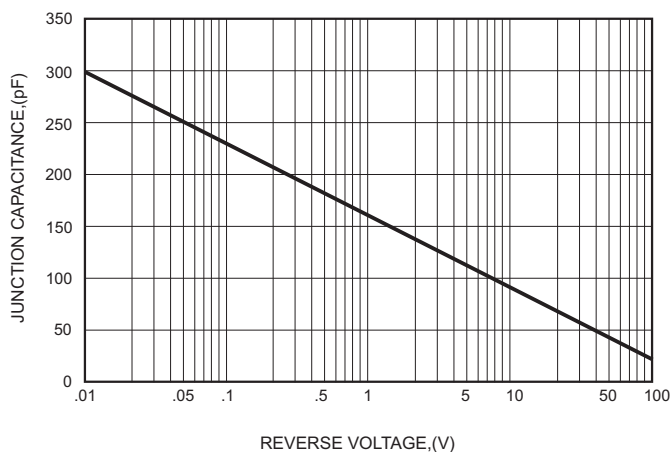



FIG.5-TYPICAL JUNCTION CAPACITANCE



**Pinning information**

Pin	Simplified outline	Symbol
Pin1 cathode Pin2 anode		

**Reel packing**

PACKAGE	REEL SIZE	REEL (pcs)	COMPONENT SPACING (m/m)	BOX (pcs)	INNER BOX (m/m)	REEL DIA. (m/m)	CARTON SIZE (m/m)	CARTON (pcs)	APPROX. GROSS WEIGHT (kg)
SMA-LS	7"	2,000	4.0	20,000	183*170*183	178	382*356*387	160,000	16.0
SMA-LS	13"	7,500	4.0	15,000	337*337*37	330	350*330*360	120,000	14.2

**Marking**

Type number	Marking code
SL12-L-TH	SL12
SL14-L-TH	SL14

Note: L: Package code, SMA-LS

-T: Taping Reel

**Pb-Free package is available**

RoHS product for packing code suffix "G"

Halogen free product for packing code suffix "H"

**Suggested solder pad layout**

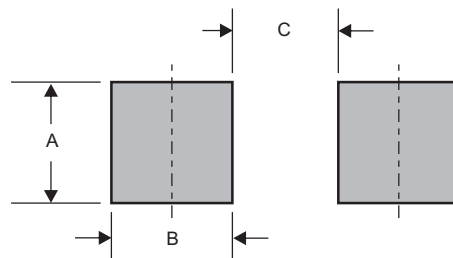

Dimensions in inches and (millimeters)

PACKAGE	A	B	C
SMA-LS	0.110 (2.80)	0.063 (1.60)	0.087 (2.20)

**Packing information**

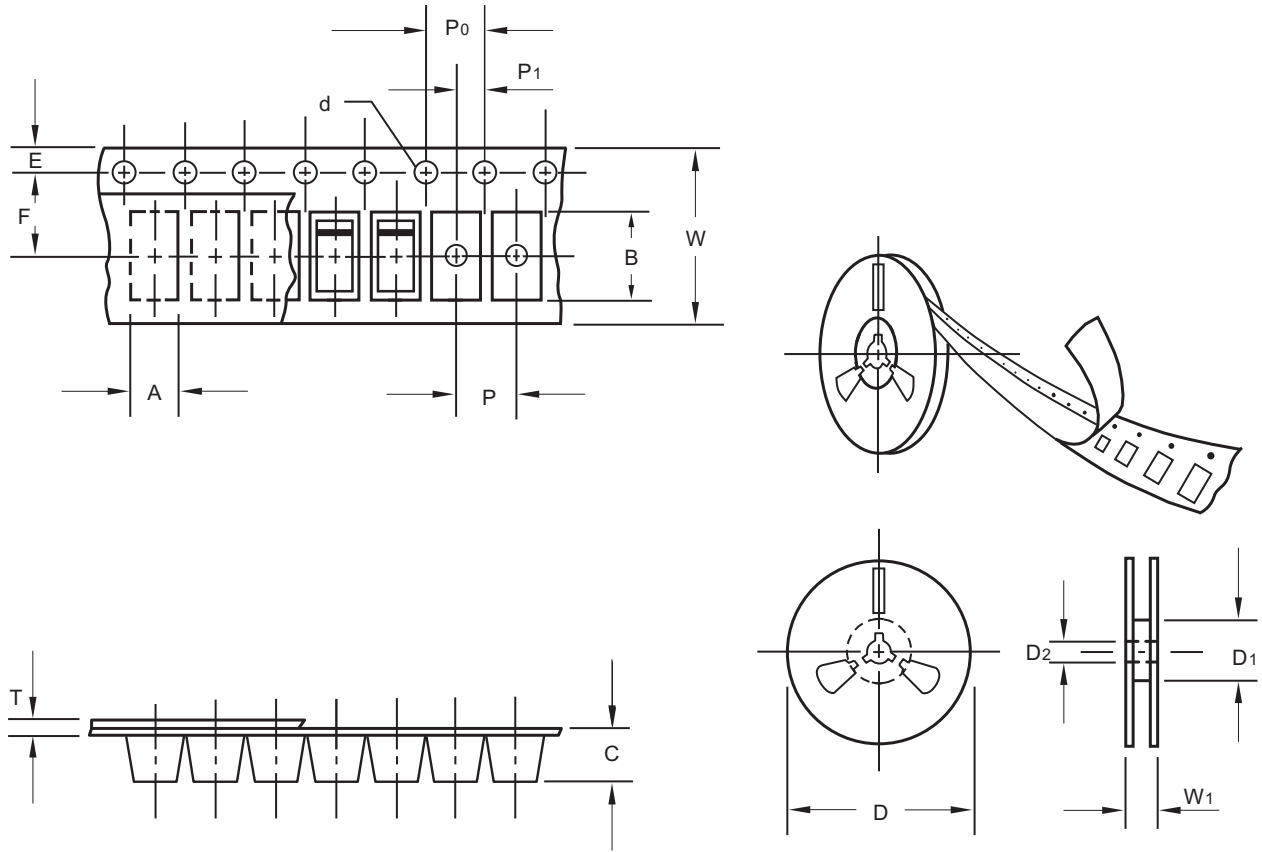

unit:mm

Item	Symbol	Tolerance	SMA-LS
Carrier width	A	0.1	2.80
Carrier length	B	0.1	5.00
Carrier depth	C	0.1	1.90
Sprocket hole	d	0.1	1.50
13" Reel outside diameter	D	2.0	330.00
13" Reel inner diameter	D1	min	50.00
7" Reel outside diameter	D	2.0	178.00
7" Reel inner diameter	D1	min	62.00
Feed hole diameter	D2	0.5	13.00
Sprocket hole position	E	0.1	1.75
Punch hole position	F	0.1	5.50
Punch hole pitch	P	0.1	4.00
Sprocket hole pitch	P0	0.1	4.00
Embossment center	P1	0.1	2.00
Overall tape thickness	T	0.1	0.23
Tape width	W	0.3	12.00
Reel width	W1	1.0	18.00

Note: Devices are packed in accordance with EIA standard RS-481-A and specifications listed above.