

SILICON PIN DIODE

DESCRIPTION:

The **ASI 5082-3039** is a Silicon PIN Diode Designed for General Purpose Attenuator and Switching Applications from 100 MHz to 3 GHz.

MAXIMUM RATINGS

I_F	100 mA
V_R	150 V
P_{DISS}	250 mW @ T _A = 25 °C
T_J	-65 °C to +200 °C
T_{STG}	-65 °C to +200 °C
θ_{JC}	0.7 °C/mW

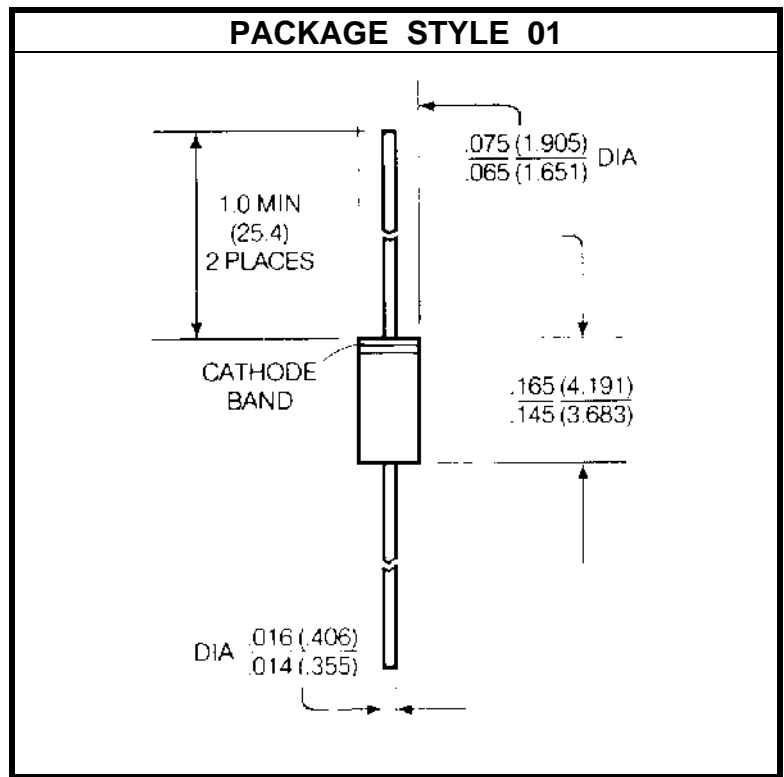
CHARACTERISTICS T_C = 25 °C

SYMBOL	TEST CONDITIONS	MINIMUM	TYPICAL	MAXIMUM	UNITS
V_{BR}	I _R = 10 μA	150			V
C_T	V _R = 50 V f = 1.0 MHz			0.25	pF
R_S	I _F = 100 mA f = 100 MHz			1.25	Ω
τ	I _F = 50 mA I _R = 250 mA	100			nS
t_{rr}	V _R = 10 V f = 20 MHz		100		nS