



SDI260 / SDI2100

MICRO SURFACE MOUNT SCHOTTKY BRIDGE

VOLTAGE 60 / 100 Volts **CURRENT** 2 Amperes

DIP Unit : inch(mm)

FEATURES

- Plastic package has Underwriters Laboratory Flammability Classification 94V-O. Flame Retardant Epoxy Molding Compound.
- Exceeds environmental standards of MIL-S-19500/228
- Low power loss, high efficiency.
- Low forward voltage, high current capability
- High surge capacity.
- Super fast recovery times, high voltage.
- Epitaxial chip construction.
- Ultra thin profile package for space constrained utilization
- Lead free in comply with EU RoHS 2011/65/EU directives.
- Green molding compound as per IEC61249 Std. . (Halogen Free)

MECHANICAL DATA

- Case: Reliable construction utilizing molded plastic technique results in product
- Terminals: Lead solderable per MIL-STD-750, Method 2026
- Polarity: Polarity symbols molded or marking on body
- Weight: 0.011 ounce, 0.4 gram

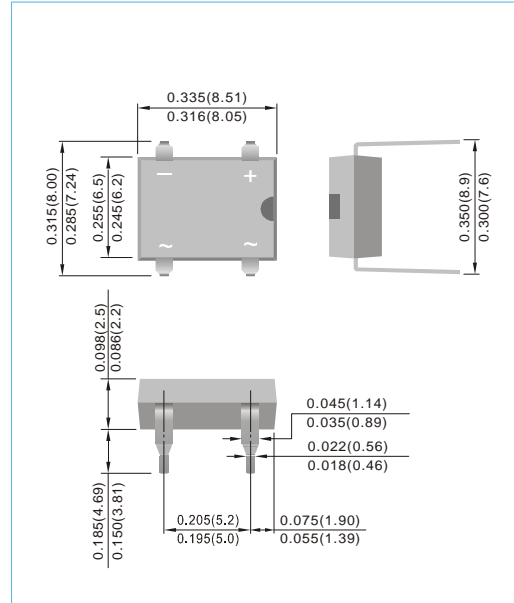

MAXIMUM RATINGS AND ELECTRICAL CHARACTERISTICS

Ratings at 25°C ambient temperature unless otherwise specified. Single phase, half wave, 60Hz, Resistive or inductive load.
For capacitive load, derate current by 20%

| PARAMETER | SYMBOL | SDI260 | SDI2100 | UNITS |
|--|-----------------|--------------|---------|--------|
| Maximum Recurrent Peak Reverse Voltage | V_{RRM} | 60 | 100 | V |
| Maximum RMS Voltage | V_{RMS} | 42 | 70 | V |
| Maximum DC Blocking Voltage | V_{DC} | 60 | 100 | V |
| Maximum Average Forward Rectified Current | $I_{F(AV)}$ | 2 | | A |
| Peak Forward Surge Current : 8.3ms single half sine-wave superimposed on rated load (JEDEC method) per diode | I_{FSM} | 50 | | A |
| Maximum Forward Voltage at 2A per diode | V_F | 0.68 | 0.84 | V |
| Maximum DC Reverse Current at Rated DC Blocking Voltage per diode | I_R | 50 | 4 | uA |
| Typical Junction Capacitance ($V_R=4V, f=1MHz$) | C_J | 130 | 125 | pF |
| Typical Thermal Resistance per diode (Note 1) | $R_{\theta JA}$ | 85 | 85 | °C / W |
| (Note 2) | $R_{\theta JL}$ | 31 | 20 | |
| Operating and Storage Temperature Range | T_J | -55 to + 150 | | °C |
| Storage Temperature Range | T_{STG} | -55 to + 150 | | °C |

NOTES:

1. Mounted on an FR4 PCB, single-sided copper, mini pad.
2. Mounted on an FR4 PCB, single-sided copper, with 48cm² copper pad area.



SDI260 / SDI2100

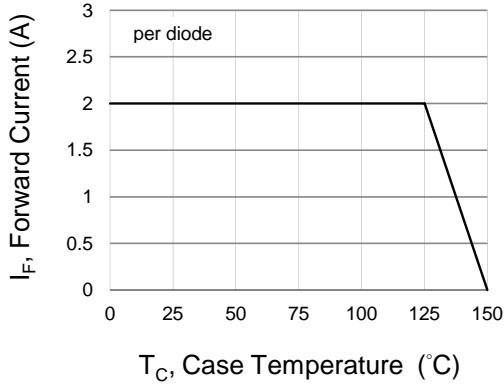

Fig.1 Forward Current Derating Curve

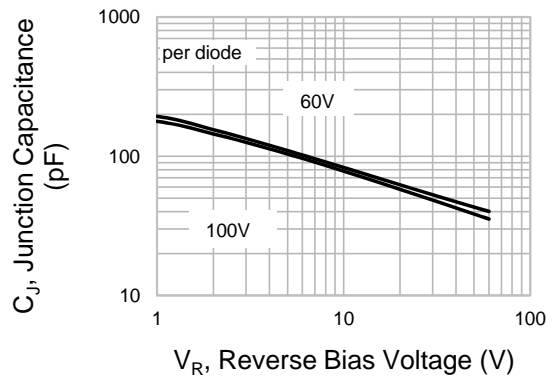

Fig.2 Typical Junction Capacitance

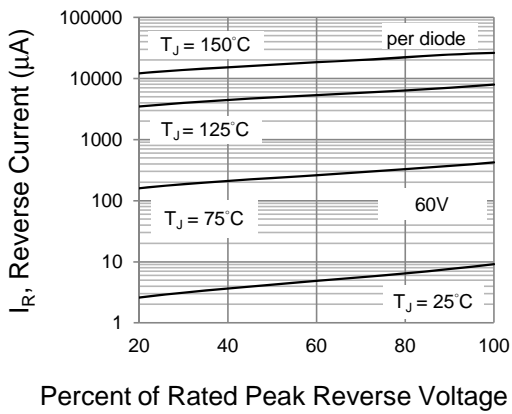

Fig.3 Typical Reverse Characteristics

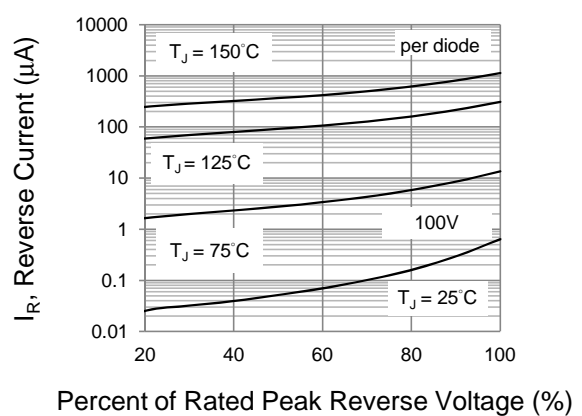

Fig.4 Typical Reverse Characteristics

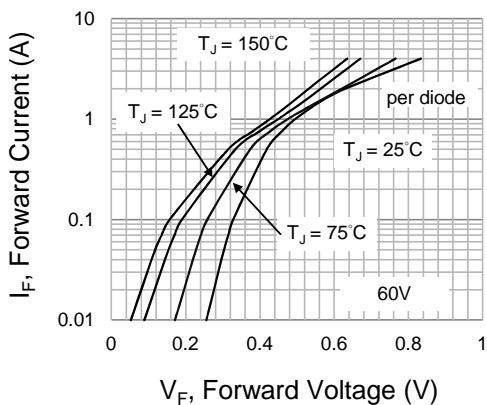

Fig.5 Typical Forward Characteristics

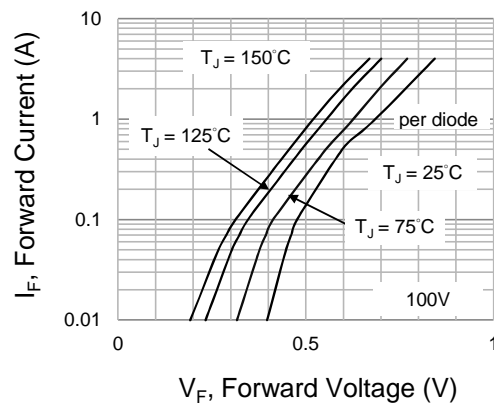

Fig.6 Typical Forward Characteristics



SDI260 / SDI2100

Part No_packing code_Version

SDI260_T0_00001

For example :

RB500V-40_R2_00001



| Packing Code XX | | | | Version Code XXXXX | | |
|--------------------------------------|----------------------|----------------------------------|----------------------|--------------------|----------------------|---------------------------------------|
| Packing type | 1 st Code | Packing size code | 2 nd Code | HF or RoHS | 1 st Code | 2 nd ~5 th Code |
| Tape and Ammunition Box (T/B) | A | N/A | 0 | HF | 0 | serial number |
| Tape and Reel (T/R) | R | 7" | 1 | RoHS | 1 | serial number |
| Bulk Packing (B/P) | B | 13" | 2 | | | |
| Tube Packing (T/P) | T | 26mm | X | | | |
| Tape and Reel (Right Oriented) (TRR) | S | 52mm | Y | | | |
| Tape and Reel (Left Oriented) (TRL) | L | PANASERT T/B CATHODE UP (PBCU) | U | | | |
| FORMING | F | PANASERT T/B CATHODE DOWN (PBCD) | D | | | |



SDI260 / SDI2100

Disclaimer

- Reproducing and modifying information of the document is prohibited without permission from Panjit International Inc..
- Panjit International Inc. reserves the rights to make changes of the content herein the document anytime without notification. Please refer to our website for the latest document.
- Panjit International Inc. disclaims any and all liability arising out of the application or use of any product including damages incidentally and consequentially occurred.
- Panjit International Inc. does not assume any and all implied warranties, including warranties of fitness for particular purpose, non-infringement and merchantability.
- Applications shown on the herein document are examples of standard use and operation. Customers are responsible in comprehending the suitable use in particular applications. Panjit International Inc. makes no representation or warranty that such applications will be suitable for the specified use without further testing or modification.
- The products shown herein are not designed and authorized for equipments requiring high level of reliability or relating to human life and for any applications concerning life-saving or life-sustaining, such as medical instruments, transportation equipment, aerospace machinery et cetera. Customers using or selling these products for use in such applications do so at their own risk and agree to fully indemnify Panjit International Inc. for any damages resulting from such improper use or sale.
- Since Panjit uses lot number as the tracking base, please provide the lot number for tracking when complaining.