

CR10CY

MEDIUM POWER, INVERTER USE
NON-INSULATED TYPE, GLASS PASSIVATION TYPE

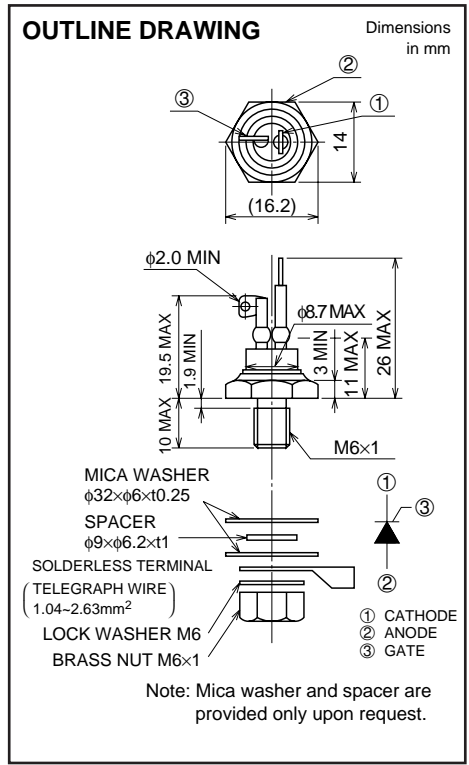

APPLICATION

Inverter, DC choppers, DC static switches, pulse generator

MAXIMUM RATINGS

Symbol	Parameter	Voltage class		Unit
		8	12	
VRRM	Repetitive peak reverse voltage	400	600	V
VRSM	Non-repetitive peak reverse voltage	500	720	V
VDRM	Repetitive peak off-state voltage	400	600	V
VDSM	Non-repetitive peak off-state voltage	500	720	V

Symbol	Parameter	Conditions	Ratings	Unit
I_T (RMS)	RMS on-state current		15.5	A
I_T (AV)	Average on-state current	Commercial frequency, sine half wave, 180°C conduction, $T_c=66^\circ\text{C}$	10	A
I_{TSM}	Surge on-state current	60Hz sine half wave 1 full cycle, peak value, non-repetitive	200	A
i^2t	i^2t for fusing	Value corresponding to 1 cycle of half wave 60Hz, surge on-state current	165	A ² s
di/dt	Critical rate of rise of on-state current	$V_D=1/2V_{DRM}$, $I_{TM}=30\text{A}$, $I_G=0.1\text{A}$, $T_c=25^\circ\text{C}$, $f=60\text{Hz}$	100	A/ μs
PGM	Peak gate power dissipation		5.0	W
PG (AV)	Average gate power dissipation		0.5	W
VFGM	Peak gate forward voltage		10	V
VRGM	Peak gate reverse voltage		5	V
IFGM	Peak gate forward current		2	A
T_j	Junction temperature		-30 ~ +125	°C
T_{stg}	Storage temperature		-30 ~ +125	°C
—	Mounting torque		30	kg-cm
			2.94	N-m
—	Weight	Typical value	8.8	g

CR10CY

MEDIUM POWER, INVERTER USE
NON-INSULATED TYPE, GLASS PASSIVATION TYPE

ELECTRICAL CHARACTERISTICS

Symbol	Parameter	Test conditions	Limits			Unit
			Min.	Typ.	Max.	
IRRM	Repetitive peak reverse current	$T_j=125^\circ\text{C}$, V_{RRM} applied	—	—	4.0	mA
IDRM	Repetitive peak off-state current	$T_j=125^\circ\text{C}$, V_{DRM} applied	—	—	4.0	mA
V_{TM}	On-state voltage	$T_c=25^\circ\text{C}$, $I_{TM}=30\text{A}$, Instantaneous value	—	—	2.5	V
dv/dt	Critical rate of rise of off-state voltage	$T_j=125^\circ\text{C}$, $V_D=2/3V_{DRM}$	100	—	—	V/ μs
VGT	Gate trigger voltage	$T_j=25^\circ\text{C}$, $V_D=6\text{V}$, $I_T=0.5\text{A}$	—	—	2.5	V
VGD	Gate non-trigger voltage	$T_j=125^\circ\text{C}$, $V_D=1/2V_{DRM}$	0.25	—	—	V
IGT	Gate trigger current	$T_j=25^\circ\text{C}$, $V_D=6\text{V}$, $I_T=0.5\text{A}$	—	—	40	mA
t _{gt}	Turn-on time	$T_j=25^\circ\text{C}$, $V_D=100\text{V}$, $I_T=10\text{A}$, $I_G=0.1\text{A}$	—	—	10	μs
t _q	Turn-off time	$I_T=10\text{A}$, $V_R=50\text{V}$, $V_D=1/2V_{DRM}$, $T_j=125^\circ\text{C}$, $dv/dt=20\text{V}/\mu\text{s}$	—	—	15	μs
R _{th(j-c)}	Thermal resistance	Junction to case	—	—	2.0	$^\circ\text{C}/\text{W}$
R _{th(c-f)}	Contact thermal resistance	Case to fin, greased	—	—	0.55	$^\circ\text{C}/\text{W}$

PERFORMANCE CURVES

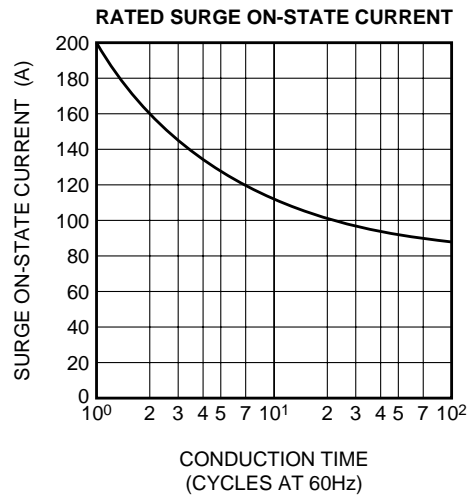
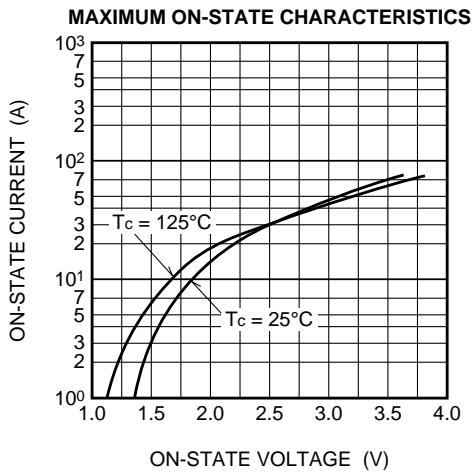

CR10CY

MEDIUM POWER, INVERTER USE
NON-INSULATED TYPE, GLASS PASSIVATION TYPE

GATE CHARACTERISTICS

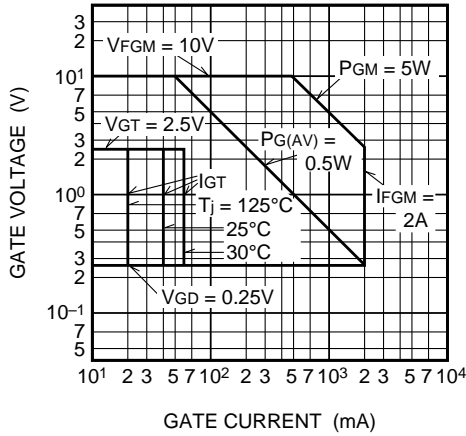

MAXIMUM TRANSIENT THERMAL IMPEDANCE CHARACTERISTICS (JUNCTION TO CASE)

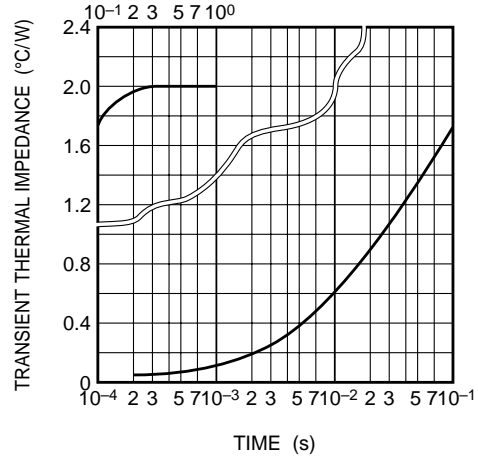

MAXIMUM AVERAGE POWER DISSIPATION (SINGLE-PHASE HALF WAVE)

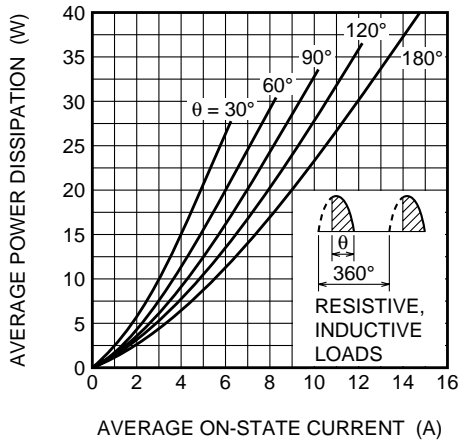

ALLOWABLE CASE TEMPERATURE VS. AVERAGE ON-STATE CURRENT (SINGLE-PHASE HALF WAVE)

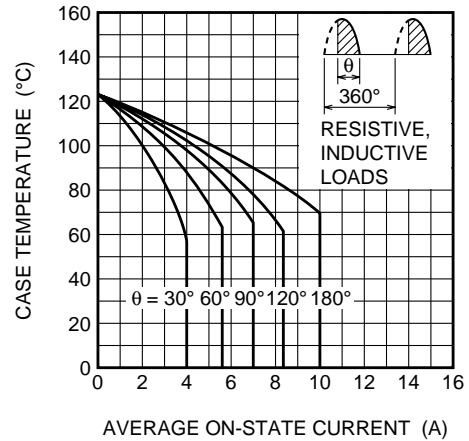

ALLOWABLE AMBIENT TEMPERATURE VS. AVERAGE ON-STATE CURRENT (SINGLE-PHASE HALF WAVE)

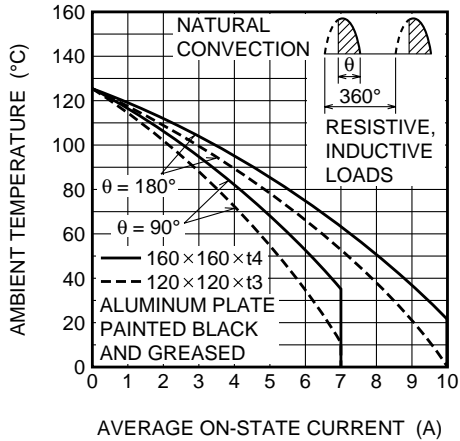

MAXIMUM AVERAGE POWER DISSIPATION (SINGLE-PHASE FULL WAVE)

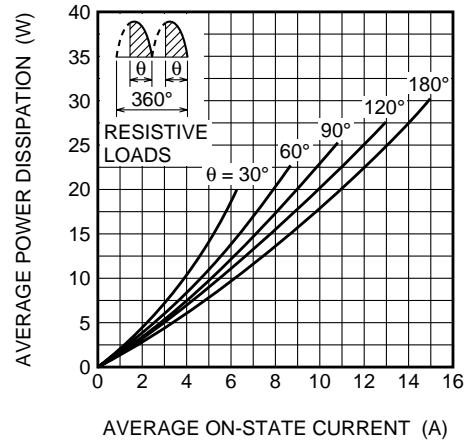

CR10CY

**MEDIUM POWER, INVERTER USE
NON-INSULATED TYPE, GLASS PASSIVATION TYPE**

**ALLOWABLE CASE TEMPERATURE VS.
AVERAGE ON-STATE CURRENT
(SINGLE-PHASE FULL WAVE)**

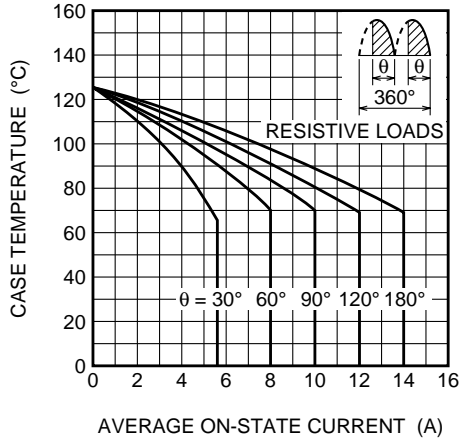

**ALLOWABLE AMBIENT TEMPERATURE VS.
AVERAGE ON-STATE CURRENT
(SINGLE-PHASE FULL WAVE)**

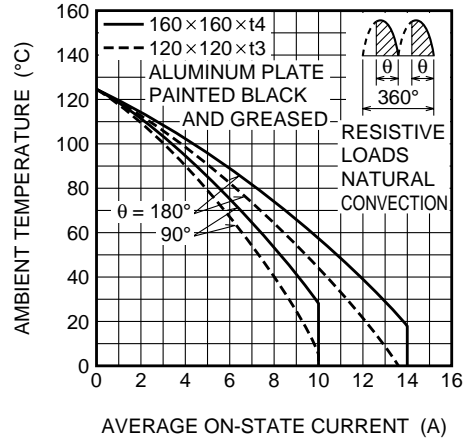

**MAXIMUM AVERAGE POWER DISSIPATION
(RECTANGULAR WAVE)**

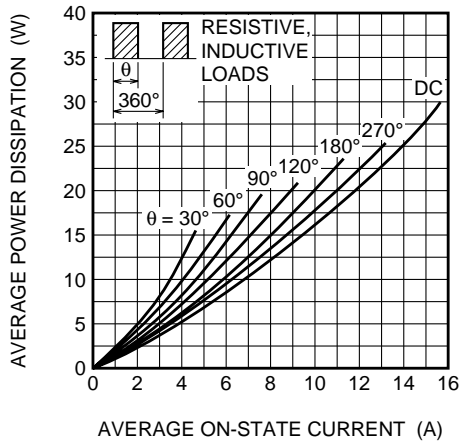

**ALLOWABLE CASE TEMPERATURE VS.
AVERAGE ON-STATE CURRENT
(RECTANGULAR WAVE)**

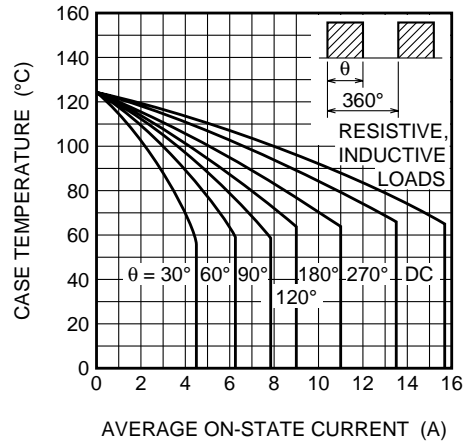

**ALLOWABLE AMBIENT TEMPERATURE VS.
AVERAGE ON-STATE CURRENT
(RECTANGULAR WAVE)**

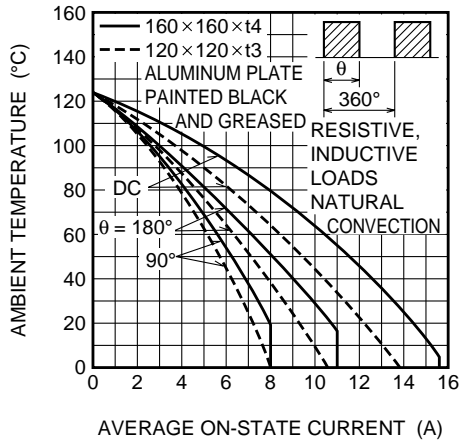

**TURN-OFF TIME VS.
JUNCTION TEMPERATURE**

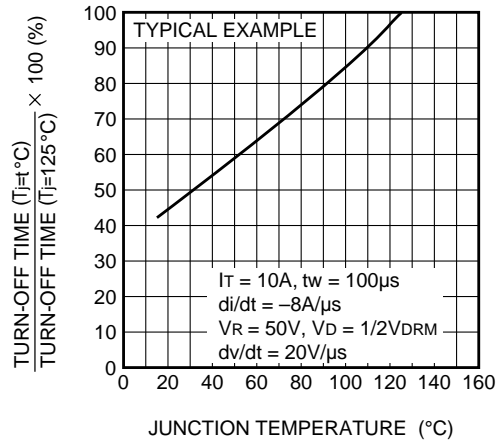

CR10CY

MEDIUM POWER, INVERTER USE
NON-INSULATED TYPE, GLASS PASSIVATION TYPE

