



YENYO

# HFR15A12D

Glass Passivated Hyperfast Recovery Rectifier

## Features

- ★ Fast switching for high efficiency
- ★ Low noise
- ★  $T_{rr} = 25\text{ns}$
- ★ Low reverse leakage current
- ★ High voltage super FRD
- ★ PFC application

## Mechanical Data

- ★ Case: Molded plastic TO-220AC
- ★ Epoxy: UL 94V-0 rate flame retardant
- ★ Terminals: Solderable per MIL-STD-202 method 208
- ★ Mounting position: Any
- ★ Weight: 2.07 grams

**Voltage Range 1200 V**  
**Current 15.0 Ampere**

## TO-220AC

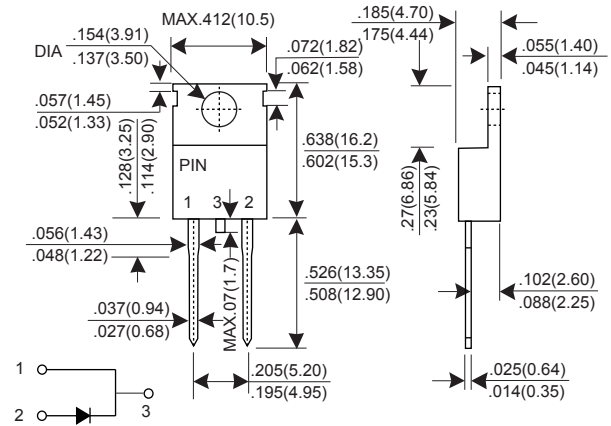

Dimensions in inches and (millimeters)

## Maximum Ratings $T_c = 25^\circ\text{C}$ , Unless Otherwise Specified

Item	Symbol	Conditions	UNIT
Recurrent Peak Reverse Voltage	VRRM	1200	V
RMS Voltage	VRMS	840	V
DC Blocking Voltage	VDC	1200	V
Average Forward Rectified Current $T_c=140^\circ\text{C}$	IF(AV)	15.0	A
Peak Forward Surge Current, 8.3ms single Half sine-wave superimposed on rated load (JEDEC method)	IFSM	200	A
Pulse energy in avalanche mode, non repetitive (inductive load switch off) $I_{(BR)R} = 1\text{A}$ , $T_J = 25^\circ\text{C}$	ER	20	mJ
Operating Junction and Storage Temperature Range	TJ, TSTG	-65 ~ +175	$^\circ\text{C}$

## Electrical/Thermal Characteristics $T_c = 25^\circ\text{C}$ , Unless Otherwise Specified

Item	Symbol	Conditions	Min.	Typ.	Max.	UNIT
Instantaneous Forward Voltage	VF	IF = 15A	-	-	4.5	V
DC Reverse Current At Rated DC Blocking Voltage	IR	VR = 1200V VR = 1200V $T_J=150^\circ\text{C}$	-	-	10.0 500	$\mu\text{A}$ $\mu\text{A}$
Maximum Reverse Recovery Time	Trr	IF = 0.5A, IR = 1.0A, Irr = 0.25A	-	-	25	nS
		IF = 15A, dIF/dt = 100A/us	-	-	70	nS
Typical junction Capacitance	CJ	VR = 10V, IF = 0A	-	55	-	pF
Typical Thermal Resistance	RθJC	Junction to Case	-	-	1.5	$^\circ\text{C/W}$

FIG.1 - FORWARD CURRENT DERATING CURVE

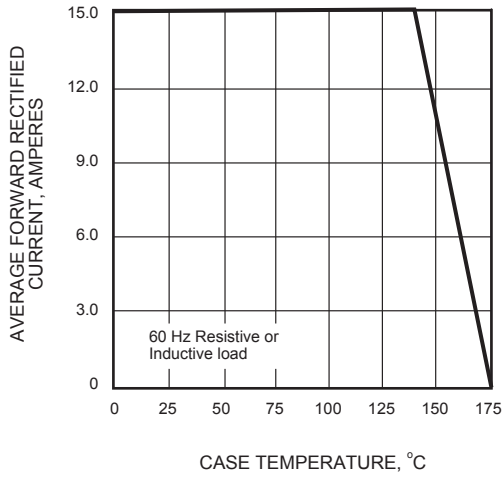

FIG.2 - MAXIMUM NON-REPETITIVE PEAK FORWARD SURGE CURRENT

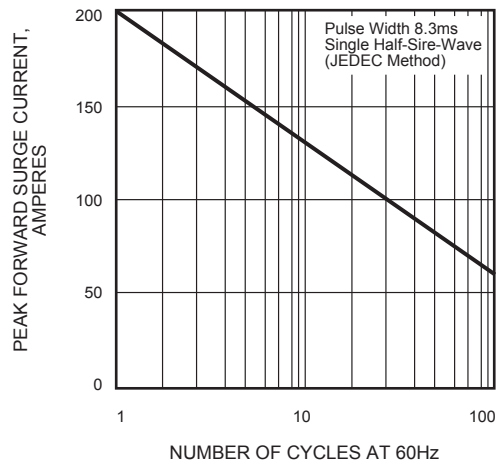

FIG.3 - TYPICAL INSTANTANEOUS FORWARD CHARACTERISTICS

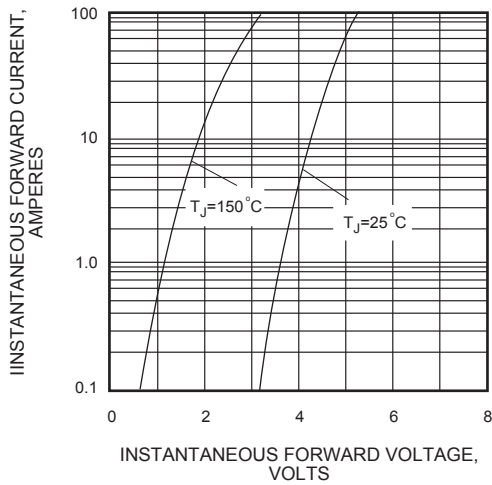

FIG.4 - TYPICAL REVERSE CHARACTERISTICS

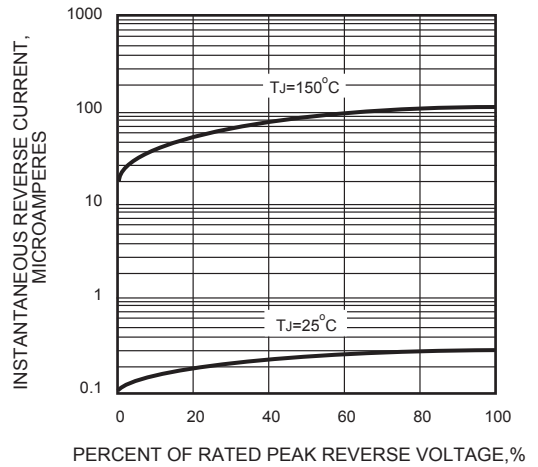

FIG.5 - JUNCTION CAPACITANCE vs REVERSE VOLTAGE

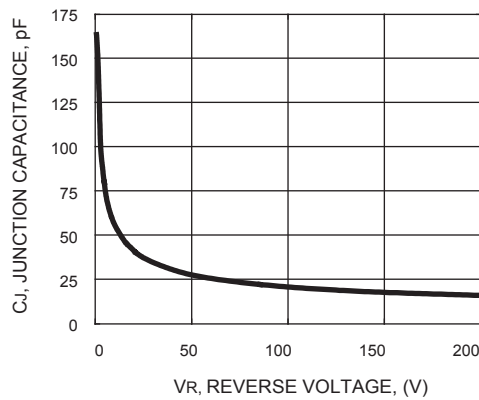

FIG. 6 -  $t_{rr}$  TEST CIRCUIT

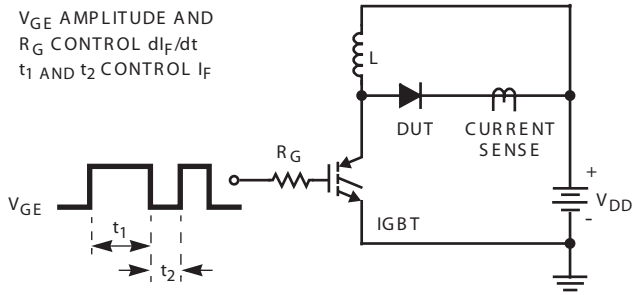

FIG. 7 -  $t_{rr}$  WAVEFORMS AND DEFINITIONS

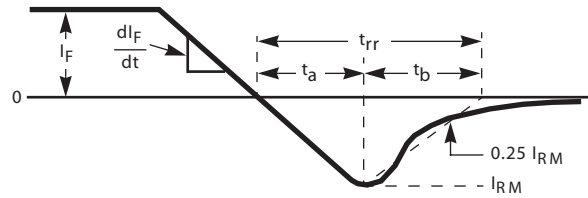

FIG. 8 - AVALANCHE ENERGY TEST CIRCUIT

$I_{MAX} = 1A$   
 $L = 40mH$   
 $R < 0.1$   
 $E_{AVL} = 1/2LI^2 [V_{R(AVL)}/(V_{R(AVL)} - V_{DD})]$   
 $Q_1 = IGBT (BV_{CES} > DUT V_{R(AVL)})$

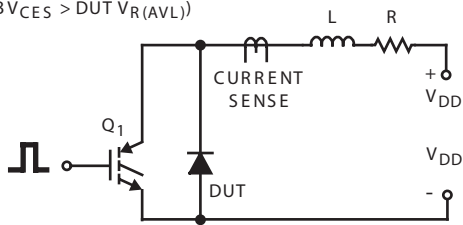

FIG. 9 - AVALANCHE CURRENT AND VOLTAGE WAVEFORMS

