

# ISDN TRANSFORMERS "U" INTERFACE

## P/N T-1054

Parameter	Min.	Typ.	Max.	Units
Inductance (1-4), Shorted pins 2,3 <sup>(1)</sup>	13.0	14.5	15.95	mH
Inductance (1-4), Shorted pins 2,3 <sup>(2)</sup>	12.4			mH
Leakage Inductance <sup>(3)</sup>		44		$\mu$ H
Interwinding Capacitance <sup>(3)</sup>		50		pF
DC Resistance (1-4) With pins 2-3, Shorted			12.5	$\Omega$
DC Resistance (5-6)			8.9	$\Omega$
Hi-Pot Pins (1-10) to	2500			V <sub>RM</sub>
Primary Impedance, Z <sub>p</sub>	128	135	141	$\Omega$
Secondary Impedance, Z <sub>s</sub>		78		$\Omega$

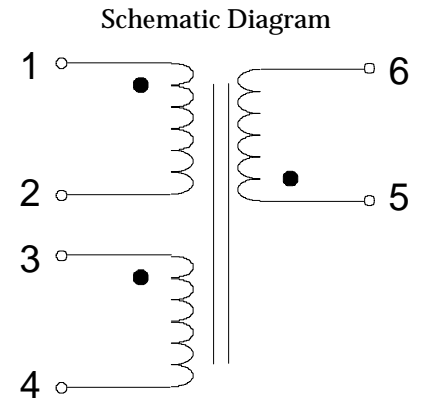

1. Measured at 40 kHz, 1.0 Vrms, 0 mAdc.
2. Measured at 40 kHz, 1.0 Vrms, 40 mAdc.
3. Measured at 100 kHz.

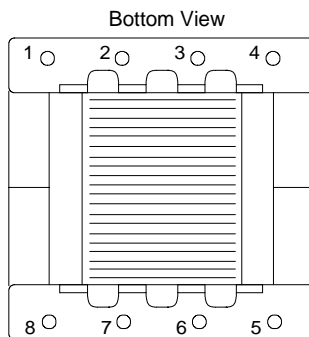
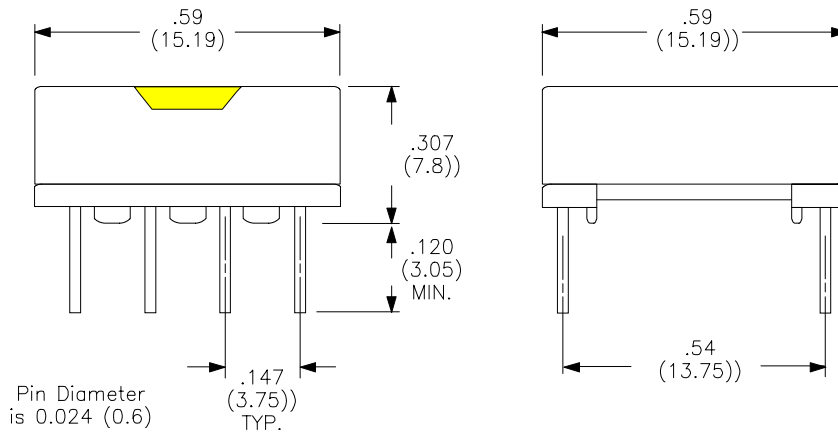

Physical  
Dimensions  
inches (mm)

4/3/98