

TO-252-4L
(PPAK)

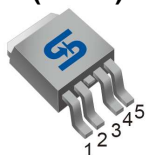

Pin Definition:

1. Enable
2. Input
3. Ground (tab)
4. Output
5. Flag / Feedback

General Description

The TS39103 are 1A ultra low dropout linear voltage regulators that provide low voltage, high current output from an extremely small package. These regulators offers extremely low dropout (typically 400mV at 1A) and very low ground current (typically 17mA at 1A).

The TS39103 are fully protected against over current faults, reversed input polarity, reversed lead insertion, over temperature operation, positive and negative transient voltage spikes, logic level enable control and error flag which signals whenever the output falls out of regulation.

Features

- Dropout voltage typically 0.4V @Io=1.0A
- Output Current up to 1A
- Low Ground Current
- Extremely Fast Transient Response
- Reversed Leakage
- Reverse Battery Protection
- Current Limit & Thermal Shutdown Protection

Ordering Information

Part No.	Package	Packing
TS39103CP4xx ROG	TO-252-4L	2.5Kpcs / 13" Reel

Note: "G" denote for Halogen Free Product

Where **xx** denotes voltage option, available are

18=1.8V

25=2.5V

33=3.3V

50=5.0V

Application

- ULDO Linear Regulator for PC add-in Cards
- PowerPC™ Power Supplies
- Battery Powered Equipment
- Consumer and Personal Electronics
- High Efficiency Linear Power Supplies
- SMPS Post Regulator and DC to DC Modules
- High-efficiency Post Regulator Switching Supply
- Portable Application
- Low-Voltage microcontrollers and Digital Logic

Typical Application Circuit

TS39103

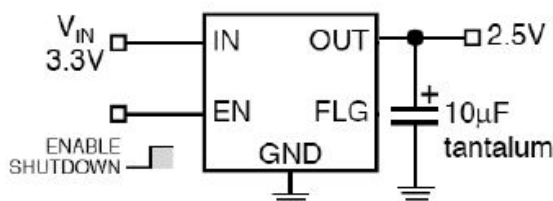
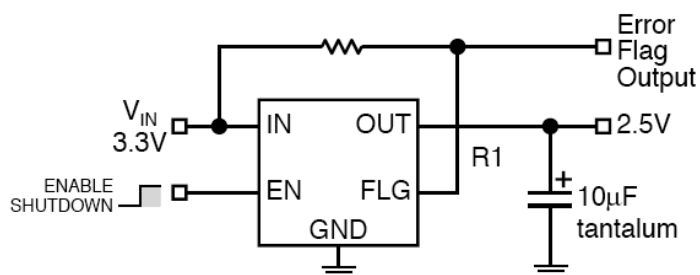

Absolute Maximum Rating (Note 1)

Parameter	Symbol	Limit	Unit
Supply Voltage	V_{IN}	-20V ~ +20	V
Enable Voltage	V_{EN}	+20	V
Storage Temperature Range	T_{STG}	-65 ~ +150	°C
Lead Soldering Temperature (260°C)		5	S
ESD		(Note 3)	

Operating Rating (Note 2)

Parameter	Symbol	Limit	Unit
Operation Input Voltage	V_{IN} (operate)	+2.25 ~ +16	V
Operation Enable Voltage	V_{EN} (operate)	+2.25 ~ +16	V
Power Dissipation (Note 4)	P_D	Internally Limited	W
Operating Junction Temperature Range	T_J	-40 ~ +125	°C
Thermal Resistance Junction to Case	$R\theta_{JC}$	20	°C/W

Electrical Characteristics

$V_{IN} = V_{OUT} + 1V$, $V_{IN} = 2.5V$ for fixed reference output voltage, $V_{enable} = 2.25V$, $T_a = 25^\circ C$, unless otherwise specified.

Parameter	Conditions	Min	Typ	Max	Unit	
Fixed Output Voltage	$10mA \leq I_L \leq 1.0A$, $V_o + 1V \leq V_{IN} \leq 8V$	0.980 Vo	V_{OUT}	1.020 Vo	V	
Line Regulation	$I_L = 10mA$, $V_o + 1V \leq V_{IN} \leq 16V$	--	0.05	0.5	%	
Load Regulation	$V_{IN} = V_{out} + 1V$, $8mA \leq I_L \leq 300mA$	--	0.05	0.1	%	
	$V_{IN} = V_{out} + 1V$, $10mA \leq I_L \leq 1A$	--	0.2	1.0		
Output Voltage Temp. Coefficient		--	40	100	ppm/°C	
Dropout Voltage (Note 5)	$\Delta V_{OUT} = -1\%$	$I_L = 100mA$	--	100	250	mV
		$I_L = 500mA$	--	275	350	
		$I_L = 1.0A$	--	400	630	
Quiescent Current (Note 6)	$V_{IN} = V_{OUT} + 1V$	$I_L = 100mA$	--	0.7	--	mA
		$I_L = 500mA$	--	6	--	
		$I_L = 1.0A$	--	17	23	
Current Limited	$V_{OUT} = 0$, $V_{IN} = V_{OUT} + 1V$	--	1.8	--	A	
Adjust Pin Bias Current		--	40	120	nA	
Reference Voltage Temp. Coefficient (Note 8)		--	20	--	ppm/°C	
Adjust Pin Bias Current Temp. Coefficient		--	0.1	--	nA/°C	

Flag Output

Output Leakage Current	$V_{OH} = 16V$	--	--	2	uA
Output Low Voltage (Note 9)	$V_{IN} = 0.9 * V_{OUT}$, $I_{OL} = 250uA$	--	--	400	mV
Upper Threshold Voltage	% of V_{OUT}	--	--	99	%
Lower Threshold Voltage	% of V_{OUT}	93	--	--	%
Hysteresis		--	1	--	%

Electrical Characteristics (Continue)

Enable Input					
Input Logic Voltage	Low (OFF)	--	--	0.8	V
	High (ON)	2.25	--	--	
Enable Pin Input Current	$V_{EN} = 2.25V$	--	--	75	uA
	$V_{EN} = 0.8V$	--	--	4	

Note 1: Absolute Maximum Rating is limits beyond which damage to the device may occur. For guaranteed specifications and test conditions see the Electrical Characteristics.

Note 2: The device is not guaranteed to operate outside its operating rating.

Note 3: Devices are ESD sensitive. Handling precautions recommended.

Note 4: The maximum allowable power dissipation is a function of the maximum junction temperature, T_J , the junction to ambient thermal resistance, Θ_{JA} , and the ambient temperature, T_a . Exceeding the maximum allowable power dissipation will cause excessive die temperature, and the regulator will go into thermal shutdown. The effective value of Θ_{JA} can be reduced by using a heat sink, $Pd_{(max)} = (T_{J(max)} - T_a) / \Theta_{JA}$.

Note 5: Dropout voltage is defined as the input to output differential at which the output voltage drops -1% below its nominal value measured at 1V differential.

Note 6: Ground pin current is the regulator quiescent current. The total current drawn from the source is the sum of the ground pin current and output load current, $I_{GND} = I_{IN} - I_{OUT}$ for fix output voltage, $I_{GND} = I_{IN} - I_{OUT} + 10mA$ for fix reference output voltage in full load regulation.

Note 7: $V_{REF} \leq V_{OUT} \leq (V_{IN} - 1V)$, $2.25V \leq V_{IN} \leq 16V$, $10mA \leq I_L \leq 1.0A$.

Note 8: Output voltage temperature coefficient is ΔV_{OUT} (worse cast) / $(T_{J(max)} - T_{J(MIN)})$ where is $T_{J(max)} + 125^\circ C$ and $T_{J(MIN)}$ is $0^\circ C$.

Note 9: For adjustable device and fixed device with $V_{OUT} > 2.25V$.

Pin Description

Pin Configuration	Pin Description
Enable	TTL/COMS compatible input. Logic high is enable; logic low or open is shutdown
Input	Unregulated input: +16V maximum supply
Ground	Ground: Ground pin and TAB / heat sink are internally connected.
Output	Regulator output
Flag (fixed voltage)	Error Flag (output): Open-collector output. Active low indicates an output fault condition, if no used, leave open.
Feed Back (adjustable)	Adjustment input: Feedback input. Connect to resistive voltage-divider network.

Functional Diagram

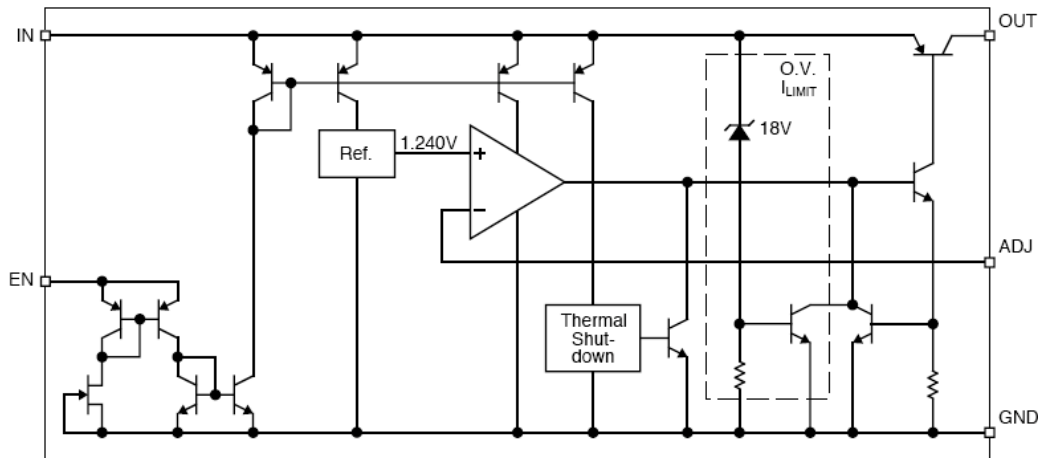

Application Information

The TS39103 are high performance with low dropout voltage regulator suitable for moderate to high current and voltage regulator application. Its 630mV dropout voltage at full load and over temperature makes it especially valuable in battery power systems and as high efficiency noise filters in post regulator applications. Unlike normal NPN transistor design, where the base to emitter voltage drop and collector to emitter saturation voltage limit the minimum dropout voltage, dropout performance of the PNP output of these devices is limited only by low V_{CE} saturation voltage.

The TS39103 is fully protected from damage due to fault conditions. Linear current limiting is provided. Output current during overload conditions is constant. Thermal shutdown the device when the die temperature exceeds the maximum safe operating temperature. Transient protection allows device survival even when the input voltage spikes above and below nominal. The output structure of these regulators allows voltages in excess of the desired output voltage to be applied without reverse current flow.

Output Capacitor Requirement

The TS39103 requires an output capacitor to maintain stability and improve transient response is necessary. The value of this capacitor is dependent upon the output current, lower currents allow smaller capacitors. TS39103 output capacitor selection is dependent upon the ESR of the output capacitor to maintain stability. When the output capacitor is 10uF or greater, the output capacitor should have an ESR less than 2Ω . This will improve transient response as well as promote stability. Ultra low ESR capacitors ($<100m\Omega$), such as ceramic chip capacitors, may promote instability. These very low ESR levels may cause an oscillation and/or under damped transient response. A low ESR solid tantalum capacitor works extremely well and provides good transient response and stability over temperature aluminum electrolytes can also be used, as long as the ESR of the capacitor is $<2\Omega$. The value of the output capacitor can be increased without limit. Higher capacitance values help to improve transient response and ripple rejection and reduce output noise.

Input Capacitor Requirement

An input capacitor of 1uF or greater is recommended when the device is more than 4" away from the bulk AC supply capacitance or when the supply is a battery. Small, surface mount, ceramic chip capacitors can be used for bypassing. Larger values will help to improve ripple rejection by bypassing the input to the regulator, further improving the integrity of the output voltage.

Minimum Load Current

The TS39103 is specified between finite loads. If the output current is too small leakage currents dominate and the output voltage rises. A 10mA minimum load current is necessary for proper regulation.

Application Information (Continue)

Transient Response and 3.3V to 2.5V or 2.5V to 1.8V Conversion

TS39103 has excellent transient response to variations in input voltage and load current. The device have been designed to respond quickly to load current variations and input voltage variations. Large output capacitors are not required to obtain this performance. A standard 10uF output capacitor, preferably tantalum, is all that is required. Larger values help to improve performance even further. By virtue of its low dropout voltage, this device does not saturate into dropout as readily as similar NPN base designs. When converting from 3.3V to 2.5V or 2.5V to 1.8V, the NPN based regulators are already operating in dropout, with typical dropout requirements of 1.2V or greater,. To convert down to 2.5V or 1.8V without operating in dropout, NPN based regulators require an input voltage of 3.7V at the very least. The TS39103 will provide excellent performance with an input as low as 3.0V or 2.5V respectively. This gives the PNP based regulators a distinct advantage over older, NPN based linear regulators.

Power Dissipation

From under curves, the minimum area of copper necessary for the par to operate safely can be determined. The maximum allowable temperature rise must be calculated to determine operation along which curve.

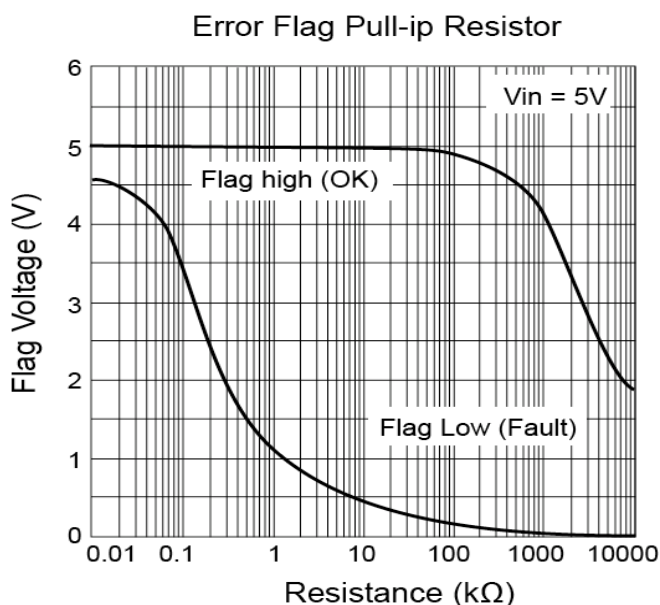
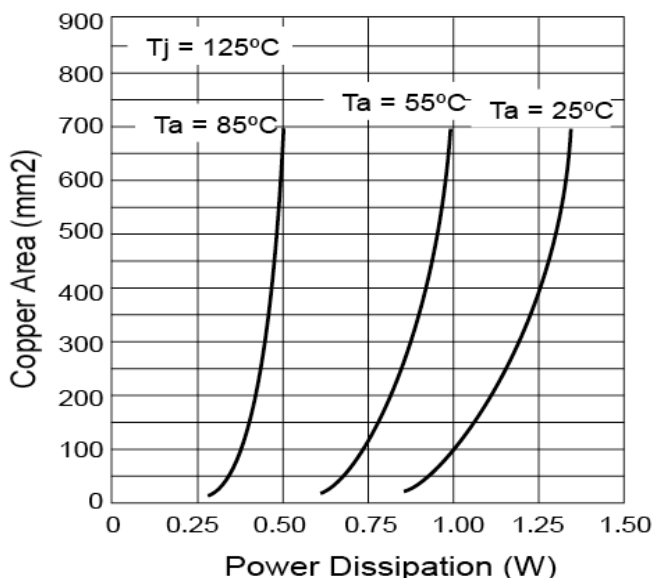

Error Flag

TS39101/3 versions feature an Error Flag, which looks at the output voltage and signals an error condition when this voltage drops 5% below its expected value. The error flag is an open-collector output that pulls low under fault conditions. It may sink 10mA. Low output voltage signifies a number of possible problems, including an over-current fault (the device is in current limit) or low input voltage. The flag output is inoperative during over temperature shutdown conditions. A pull-up resistor from error flag to either VIN or VOUT is required for proper operation. For information regarding the minimum and maximum values of pull-up resistance, refer the graph as follow:

Enable Input

TS39103 versions feature an active-high enable (EN) input that allows ON/OFF control of the regulator. Current drain reduces to "zero" when the device is shutdown, with only micro-amperes of leakage current. The EN input has TTL/CMOS compatible thresholds for simple interfacing with logic interfacing. EN may be directly tied to VIN and pulled up to the maximum supply voltage.

Application Information (Continue)

Copper area lay out information

Determine the power dissipation requirements for the design along with the maximum ambient temperature at which the device will be operated. Refer to power dissipation with copper area curve, which shows safe operating curves for three different ambient temperatures with 25°C, 50°C, 85°C. From these curves, the minimum amount of copper can be determined by knowing the maximum power dissipation required.

$$P_D = (V_{IN} - V_{OUT}) * I_{OUT} + V_{IN} * I_{GND}$$

If we used a 5.0V output device and a 6V input at an output current of 350mA, then the power dissipation is as follows:

$$P_D = (6.0V - 5.0V) * 350mA + 5V * 4mA$$

$$P_D = 350mW + 20mW$$

$$P_D = 370mW$$

If the maximum ambient temperature is 85°C and the power dissipation is as above 375mW, the curve is shows that the required area of copper is 80mm².

TO-252-4L Mechanical Drawing

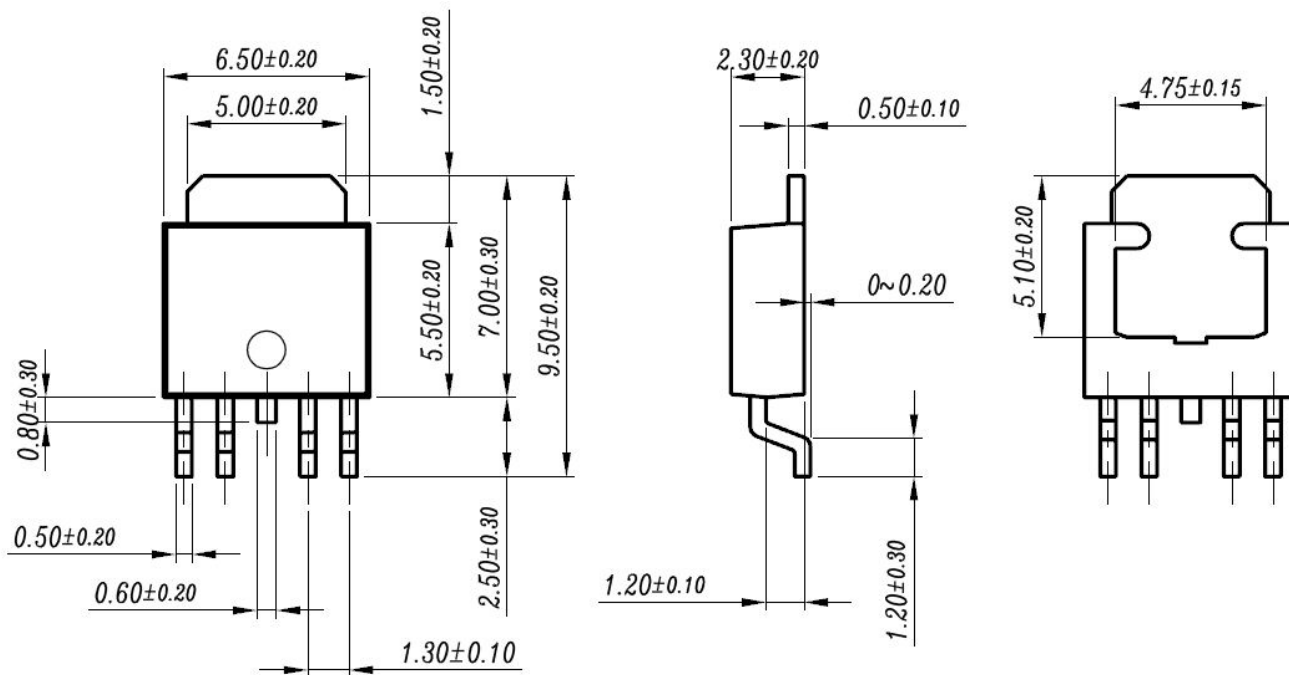

Marking Diagram

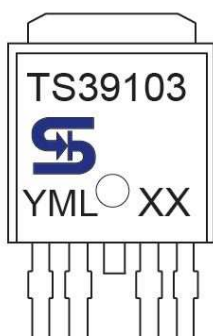

- Y** = Year Code
- M** = Month Code for Halogen Free Product
(**O**=Jan, **P**=Feb, **Q**=Mar, **R**=Apr, **S**=May, **T**=Jun, **U**=Jul, **V**=Aug, **W**=Sep, **X**=Oct, **Y**=Nov, **Z**=Dec)
- L** = Lot Code
- XX** = Output Voltage
(**18**=1.8V, **25**=2.5V, **33**=3.3V, **50**=5V)

Notice

Specifications of the products displayed herein are subject to change without notice. TSC or anyone on its behalf, assumes no responsibility or liability for any errors or inaccuracies.

Information contained herein is intended to provide a product description only. No license, express or implied, to any intellectual property rights is granted by this document. Except as provided in TSC's terms and conditions of sale for such products, TSC assumes no liability whatsoever, and disclaims any express or implied warranty, relating to sale and/or use of TSC products including liability or warranties relating to fitness for a particular purpose, merchantability, or infringement of any patent, copyright, or other intellectual property right.

The products shown herein are not designed for use in medical, life-saving, or life-sustaining applications. Customers using or selling these products for use in such applications do so at their own risk and agree to fully indemnify TSC for any damages resulting from such improper use or sale.