

### Typical Applications

The HMC239AS8 / HMC239AS8E is ideal for:

- MMDS & WirelessLAN
- Basestation Infrastructure
- Portable Wireless

### Functional Diagram

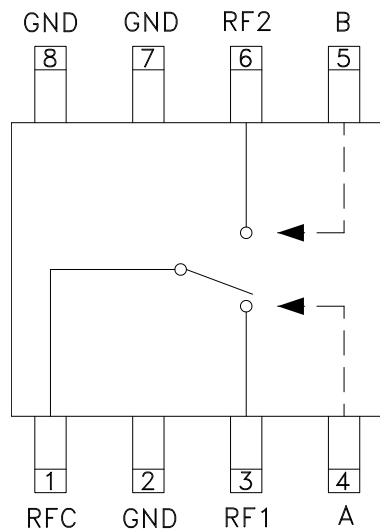

### Features

- Low Insertion Loss: 0.4 dB
- High Isolation: 35 dB
- Fast Switching Speed: 2 ns
- High Input IP3: +50 dBm

### General Description

The HMC239AS8 & HMC239AS8E are low-cost GaAs MMIC SPDT switches in 8-lead SOIC packages. The switch can control signals from DC to 2.5 GHz. It is especially suited for low or medium power applications which require extremely fast switching with minimal insertion loss. The two control voltages require a minimal amount of DC current which is optimal for battery powered radio systems. RF1 and RF2 are reflective shorts when "Off".

### Electrical Specifications, $T_A = +25^\circ\text{C}$ , $V_{ctl} = 0 / -5\text{V}$ , 50 Ohm System

Parameter	Frequency	Min.	Typ.	Max.	Units
Insertion Loss	DC - 0.1 GHz		0.4	0.6	dB
	DC - 0.5 GHz		0.4	0.6	dB
	DC - 1.0 GHz		0.5	0.7	dB
	DC - 2.0 GHz		0.6	0.8	dB
	DC - 2.5 GHz		0.7	1.0	dB
Isolation	DC - 0.5 GHz	33	36		dB
	DC - 1.0 GHz	26	29		dB
	DC - 2.0 GHz	18	21		dB
	DC - 2.5 GHz	14	17		dB
Return Loss	DC - 1.0 GHz	18	21		dB
	DC - 2.0 GHz	17	21		dB
	DC - 2.5 GHz	15	20		dB
Input Power for 1 dB Compression	0.5 - 1.0 GHz	25	29		dBm
	0.5 - 2.5 GHz	23	27		dBm
Input Third Order Intercept (Two-Tone Input Power = +7 dBm Each Tone)	0.5 - 1.0 GHz	45	50		dBm
	0.5 - 2.5 GHz	44	49		dBm
Switching Characteristics	DC - 2.5 GHz		2		ns
		tRISE, tFALL (10 / 90% RF)	10		ns
		tON, tOFF (50% CTL to 10 / 90% RF)	10		ns



### Insertion Loss

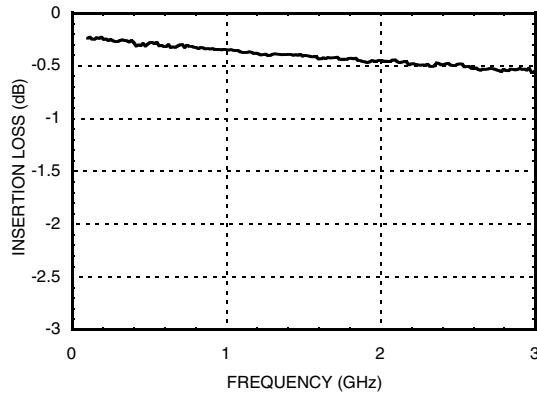

### Isolation

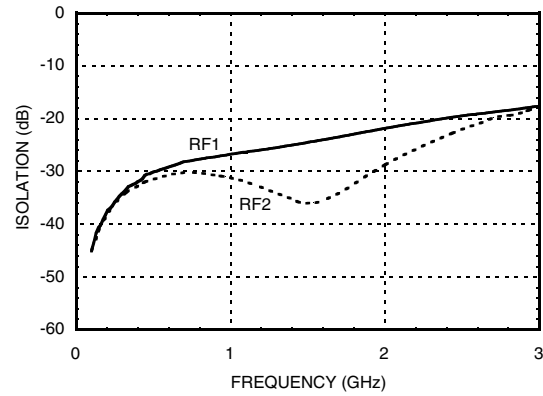

### Return Loss

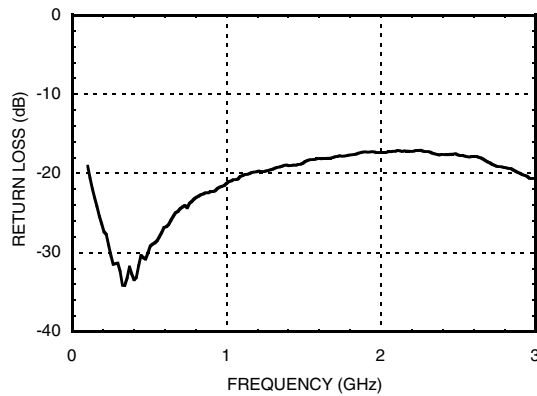

### Input 0.1 and 1.0 dB Compression vs. Control Voltage

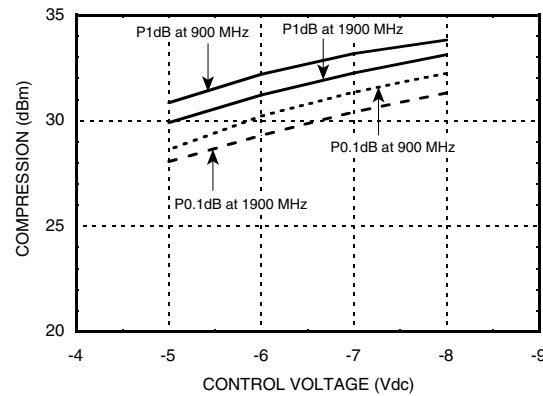

### Input Third Order Distortion vs. Control Voltage

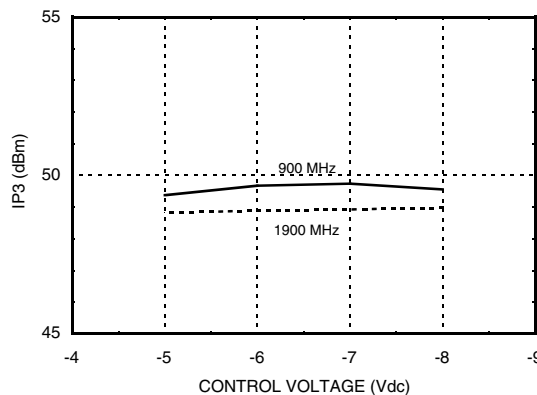

### Truth Table

\*Control Input Voltage Tolerances are  $\pm 0.2$  Vdc.

Control Input*		Control Current		Signal Path State	
A (Vdc)	B (Vdc)	Ia ( $\mu$ A)	Ib ( $\mu$ A)	RF to RF1	RF to RF2
-5	0	-5	5	ON	OFF
0	-5	5	-5	OFF	ON
-6	0	-12	12	ON	OFF
0	-6	12	-12	OFF	ON
-7	0	-20	20	ON	OFF
0	-7	20	-20	OFF	OM
-8	0	-32	32	ON	OFF
0	-8	32	-32	OFF	ON

### Compression vs. Bias Voltage

Control Input (Vdc)	Carrier at 900 MHz		Carrier at 1900 MHz	
	Input Power for 0.1 dB Compression (dBm)	Input Power for 1.0 dB Compression (dBm)	Input Power for 0.1 dB Compression (dBm)	Input Power for 1.0 dB Compression (dBm)
-5	28	30	27	29
-6	29	31	28	30
-8	31	33	30	32

Caution: Do not operate in 1 dB compression at power levels above +30 dBm and do not "hot switch" power levels greater than +20 dBm (Vctl= -5 Vdc).

### Distortion vs. Bias Voltage

Control Input (Vdc)	Third Order Intercept (dBm) +7 dBm Each Tone	
	900 MHz	1900 MHz
-5	50	49
-8	50	49

### Absolute Maximum Ratings

Max. Input Power (VCTL = 0 / -8V)	0.05 GHz 0.5 - 2 GHz	+27 dBm +34 dBm
Control Voltage Range (A & B)	+2 to -12 Vdc	
Storage Temperature	-65 to +150 °C	
Operating Temperature	-40 to +85 °C	

### Outline Drawing

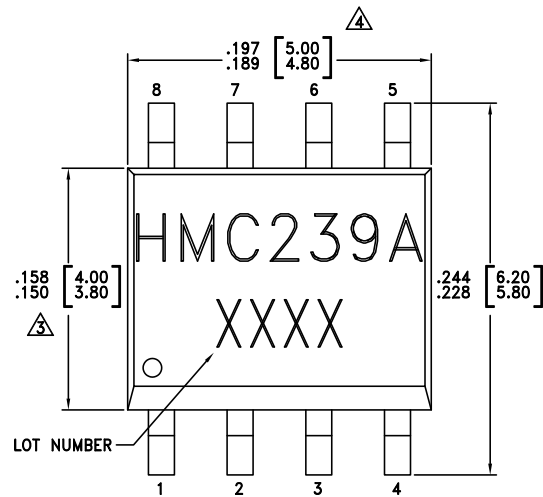

**ELECTROSTATIC SENSITIVE DEVICE  
OBSERVE HANDLING PRECAUTIONS**

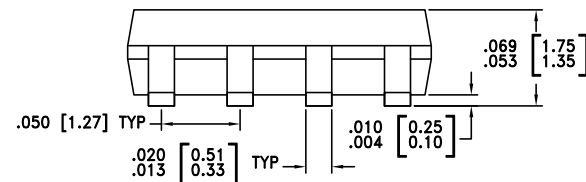
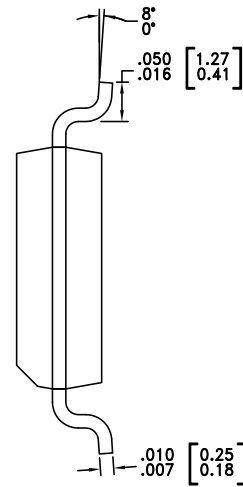

**NOTES:**

- LEADFRAME MATERIAL: COPPER ALLOY
- DIMENSIONS ARE IN INCHES (MILLIMETERS)
- DIMENSION DOES NOT INCLUDE MOLDFLASH OF 0.15 mm PER SIDE.
- DIMENSION DOES NOT INCLUDE MOLDFLASH OF 0.25 mm PER SIDE.
- ALL GROUND LEADS MUST BE SOLDERED TO PCB RF GROUND.

### Package Information

Part Number	Package Body Material	Lead Finish	MSL Rating	Package Marking <sup>[3]</sup>
HMC239AS8	Low Stress Injection Molded Plastic	Sn / Pb Solder	MSL1 <sup>[1]</sup>	HMC239A XXXX
HMC239AS8E	RoHS-compliant Low Stress Injection Molded Plastic	100% matte Sn	MSL1 <sup>[2]</sup>	HMC239A XXXX

[1] Max peak reflow temperature of 235 °C  
 [2] Max peak reflow temperature of 260 °C  
 [3] 4-Digit lot number XXXX

### Typical Application Circuit

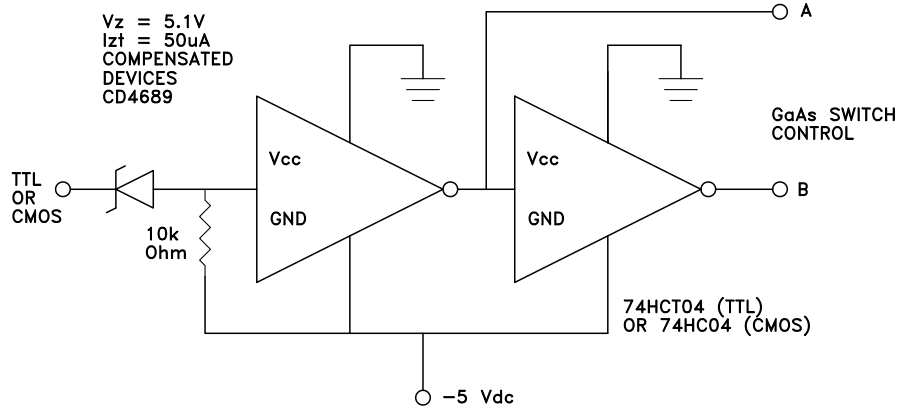

Simple driver using inexpensive standard logic ICs provides fast switching using minimum DC current.

### Evaluation Circuit Board

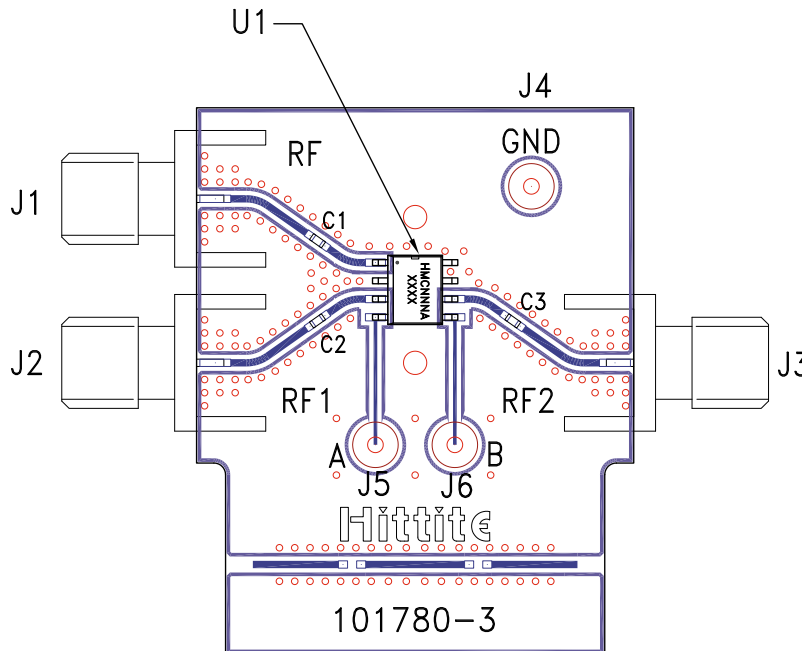

### List of Materials for Evaluation PCB 101782 [1]

Item	Description
J1 - J3	PCB Mount SMA RF Connector
J4 - J6	DC Pin
C1 - C3	330 pF capacitor, 0402 Pkg.
U1	HMC239AS8 / HMC239AS8E SPDT Switch
PCB [2]	101780 Evaluation PCB

[1] Reference this number when ordering complete evaluation PCB

[2] Circuit Board Material: Rogers 4350

The circuit board used in the application should be generated with proper RF circuit design techniques. Signal lines at the RF port should have 50 Ohm impedance and the package ground leads and package bottom should be connected directly to the ground plane similar to that shown above. The evaluation circuit board shown above is available from Hittite Microwave Corporation upon request.