



TS1851-TS1852-TS1854

1.8V input/output rail-to-rail
Low power operational amplifiers

Features

- Operates at $V_{CC} = 1.8V$ to 6V
- Rail-to-rail input and output
- Extended V_{icm} ($V_{DD} - 0.2V$ to $V_{CC} + 0.2V$)
- Low supply current (120 μ A)
- Gain bandwidth product (480kHz)
- High unity gain stability (able to drive 500pF)
- ESD tolerance (2kV)
- Latch-up immunity
- Available in SOT23-5 micropackage

Applications

- Two-cell battery-powered systems
- Battery-powered electronic equipment
- Cordless phones
- Cellular phones
- Laptops
- PDAs

Description

The TS185x (single, dual and quad) are operational amplifiers able to operate with voltages as low as 1.8V. They feature both input and output rail-to-rail (1.71 @ $V_{CC} = 1.8V$, $R_L = 2k\Omega$), 120 μ A current consumption and 480kHz gain bandwidth product.

With such a low consumption and a sufficient GBP for many applications, this op-amp is very well-suited for all kinds of battery-supplied and portable equipment applications.

The TS1851 is housed in the space-saving 5-pin SOT23-5 package which simplifies the board design (outside dimensions are 2.8mm x 2.9mm).

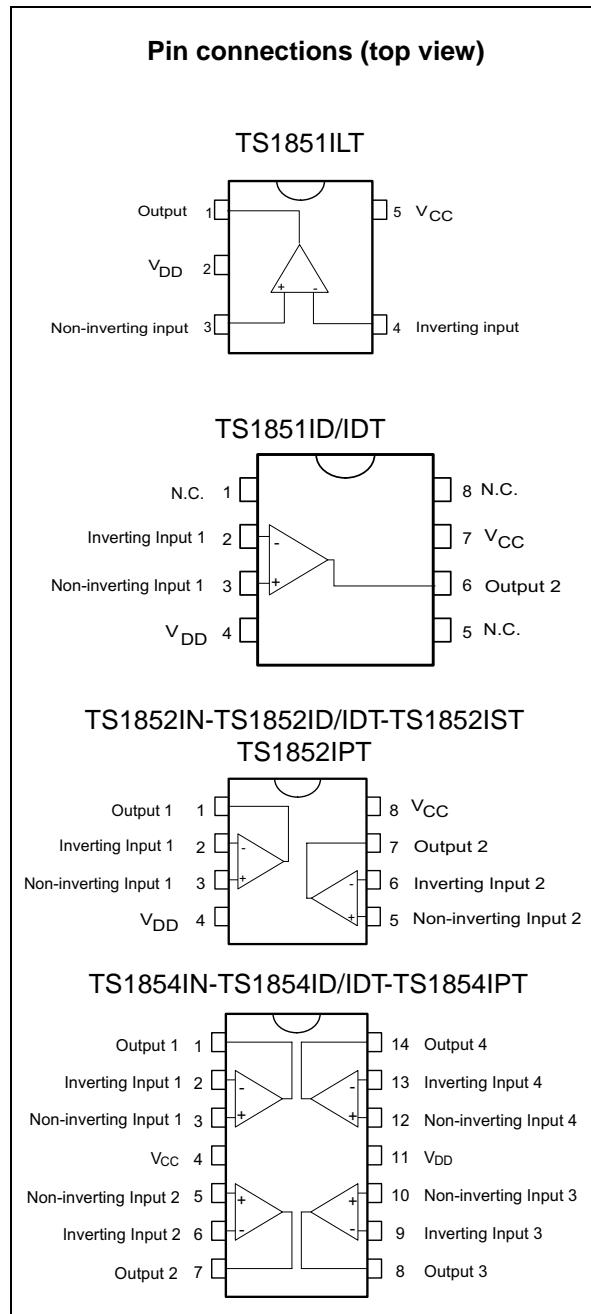

Contents

1	Absolute maximum ratings	3
2	Operating conditions	4
3	Electrical characteristics	5
4	Package information	15
	4.1 DIP8 package mechanical data	16
	4.2 SO-8 package mechanical data	17
	4.3 TSSOP8 package mechanical data	18
	4.4 MiniSO-8 package mechanical data	19
	4.5 DIP14 package mechanical data	20
	4.6 SO-14 package mechanical data	21
	4.7 TSSOP14 package mechanical data	22
	4.8 SOT23-5 package mechanical data	23
5	Ordering information	24
6	Revision history	24

1 Absolute maximum ratings

Table 1. Absolute maximum ratings

Symbol	Parameter	Value	Unit
V_{CC}	Supply voltage ⁽¹⁾	7	V
V_{id}	Differential input voltage ⁽²⁾	±1	V
V_i	Input voltage	$V_{dd} - 0.3$ to $V_{CC} + 0.3$	V
T_{oper}	Operating free air temperature range	-40 to + 125	°C
T_{stg}	Storage temperature	-65 to +150	°C
T_j	Maximum junction temperature	150	°C
R_{thja}	Thermal resistance junction to ambient ⁽³⁾		°C/W
	SOT23-5	250	
	DIP8	85	
	DIP14	66	
	miniSO-8	190	
	SO-8	125	
	SO-14	103	
	TSSOP8 TSSOP14	120 100	
R_{thjc}	Thermal resistance junction to case		°C/W
	SOT23-5	81	
	DIP8	41	
	DIP14	33	
	miniSO-8	39	
	SO-8	40	
	SO-14	31	
	TSSOP8 TSSOP14	37 32	
ESD	HBM: human body model ⁽⁴⁾	2	kV
	MM: machine model ⁽⁵⁾	200	V
	CDM: charged device model ⁽⁶⁾	1.5	kV
	Lead temperature (soldering, 10sec)	250	°C
	Output short-circuit duration	see note ⁽⁷⁾	

1. All voltage values, except differential voltage are with respect to network terminal.
2. Differential voltages are the non-inverting input terminal with respect to the inverting input terminal. If $V_{id} > \pm 1V$, the maximum input current must not exceed $\pm 1mA$. When $V_{id} > \pm 1V$, add an input series resistor to limit input current.
3. Short-circuits can cause excessive heating. Destructive dissipation can result from simultaneous short-circuits on all amplifiers.
4. Human body model: A 100pF capacitor is charged to the specified voltage, then discharged through a 1.5kΩ resistor between two pins of the device. This is done for all couples of connected pin combinations while the other pins are floating.
5. Machine model: A 200pF capacitor is charged to the specified voltage, then discharged directly between two pins of the device with no external series resistor (internal resistor < 5Ω). This is done for all couples of connected pin combinations while the other pins are floating.
6. Charged device model: all pins and the package are charged together to the specified voltage and then discharged directly to the ground through only one pin. This is done for all pins.
7. Short-circuits from the output to V_{CC} can cause excessive heating. The maximum output current is approximately 48mA, independent of the magnitude of V_{CC} . Destructive dissipation can result from simultaneous short-circuits on all amplifiers.

2 Operating conditions

Table 2. Operating conditions

Symbol	Parameter	Value	Unit
V_{CC}	Supply voltage	1.8 to 6	V
V_{icm}	Common mode input voltage range $T_{op} = 25^{\circ}\text{C}$, $1.8 \leq V_{CC} \leq 6\text{V}$ $T_{min} < T_{op} < T_{max}$, $1.8 \leq V_{CC} \leq 5.5\text{V}$	$V_{DD} - 0.2$ to $V_{CC} + 0.2$ V_{DD} to V_{CC}	V
T_{oper}	Operating free air temperature range	-40 to + 125	$^{\circ}\text{C}$

3 Electrical characteristics

Table 3. Electrical characteristics measured at $V_{CC} = +1.8V$, $V_{dd} = 0V$, with C_L & R_L connected to $V_{CC}/2$, $T_{amb} = 25^\circ C$ (unless otherwise specified) ⁽¹⁾

Symbol	Parameter	Conditions	Min.	Typ.	Max.	Unit
V_{io}	Input offset voltage	TS1851/2/4 $T_{min} \leq T_{amb} \leq T_{max}$ TS1851A/2A/4A $T_{min} \leq T_{amb} \leq T_{max}$		0.1	3 6 1 1.5	mV
ΔV_{io}	Input offset voltage drift			2		$\mu V/^\circ C$
I_{io}	Input offset current	$V_{icm} = V_{out} = V_{CC}/2$ ⁽²⁾ $T_{min} \leq T_{amb} \leq T_{max}$		1	9 25	nA
I_{ib}	Input bias current	$V_{icm} = V_{out} = V_{CC}/2$ ⁽²⁾ $T_{min} \leq T_{amb} \leq T_{max}$		10	50 80	nA
CMR	Common mode rejection ratio $20 \log (\Delta V_{ic}/\Delta V_{io})$	$0 \leq V_{icm} \leq V_{CC}$ $T_{min} \leq T_{amb} \leq T_{max}$	55 52	85		dB
A_{vd}	Large signal voltage gain	$V_{out} = 0.5V$ to $1.3V$ $R_L = 10k\Omega$ $R_L = 2k\Omega$	80 70	100 88		dB
V_{OH}	High level output voltage	$V_{id} = 100mV$ $R_L = 10k\Omega$ $R_L = 2k\Omega$ $T_{min} \leq T_{amb} \leq T_{max}$, $R_L = 10k\Omega$ $T_{min} \leq T_{amb} \leq T_{max}$, $R_L = 2k\Omega$	1.7 1.65 1.7 1.65	1.77 1.7		V
V_{OL}	Low level output voltage	$V_{id} = -100mV$ $R_L = 10k\Omega$ $R_L = 2k\Omega$ $T_{min} \leq T_{amb} \leq T_{max}$, $R_L = 10k\Omega$ $T_{min} \leq T_{amb} \leq T_{max}$, $R_L = 2k\Omega$		40 62	70 90 100 120	mV
I_o	Output source current	$V_{id} = 100mV$, $V_O = V_{DD}$	2	29		mA
	Output sink current	$V_{id} = -100mV$, $V_O = V_{CC}$	2	46		
I_{CC}	Supply current (per amplifier)	$V_{out} = V_{CC}/2$ $A_{VCL} = 1$, no load $T_{min} \leq T_{amb} \leq T_{max}$		120	170 200	μA
GBP	Gain bandwidth product	$R_L = 10k\Omega$, $C_L = 100pF$, $f = 100kHz$	300	480		kHz
SR	Slew rate	$R_L = 10k\Omega$, $C_L = 100pF$, $A_V = 1$	0.1	0.18		V/ μs
ϕ_m	Phase margin	$C_L = 100pF$		60		Degrees
en	Input voltage noise	$f = 1kHz$		40		nV/ \sqrt{Hz}
THD	Total harmonic distortion			0.01		%

1. All parameter limits at temperatures other than $25^\circ C$ are guaranteed by correlation.
2. Maximum values include unavoidable inaccuracies of the industrial tests.

Table 4. Electrical characteristics measured at $V_{CC} = +3V$, $V_{dd} = 0V$, with C_L & R_L connected to $V_{CC}/2$, $T_{amb} = 25^\circ C$ (unless otherwise specified) ⁽¹⁾

Symbol	Parameter	Conditions	Min.	Typ.	Max.	Unit
V_{io}	Input offset voltage	$V_{icm} = V_{out} = V_{CC}/2$ TS1851/2/4 $T_{min} \leq T_{amb} \leq T_{max}$ TS1851A/2A/4A $T_{min} \leq T_{amb} \leq T_{max}$		0.1	3 6 1 1.5	mV
ΔV_{io}	Input offset voltage drift			2		$\mu V/^\circ C$
I_{io}	Input offset current	$V_{icm} = V_{out} = V_{CC}/2^{(2)}$ $T_{min} \leq T_{amb} \leq T_{max}$		1	9 25	nA
I_{ib}	Input bias current	$V_{icm} = V_{out} = V_{CC}/2^{(2)}$ $T_{min} \leq T_{amb} \leq T_{max}$		10	55 85	nA
CMR	Common mode rejection ratio $20 \log (\Delta V_{ic}/\Delta V_{io})$	$0 \leq V_{icm} \leq V_{CC}$ $T_{min} \leq T_{amb} \leq T_{max}$	60 57	90		dB
A_{vd}	Large signal voltage gain	$V_{out} = 0.5V$ to $2.5V$ $R_L = 10k\Omega$ $R_L = 2k\Omega$	83 74	99 90		dB
V_{OH}	High level output voltage	$V_{id} = 100mV$ $R_L = 10k\Omega$ $R_L = 2k\Omega$ $T_{min} \leq T_{amb} \leq T_{max}, R_L = 10k\Omega$ $T_{min} \leq T_{amb} \leq T_{max}, R_L = 2k\Omega$	2.9 2.85 2.9 2.85	2.96 2.94		V
V_{OL}	Low level output voltage	$V_{id} = -100mV$ $R_L = 10k\Omega$ $R_L = 2k\Omega$ $T_{min} \leq T_{amb} \leq T_{max}, R_L = 10k\Omega$ $T_{min} \leq T_{amb} \leq T_{max}, R_L = 2k\Omega$		10 46	90 100 120 130	mV
I_o	Output source current	$V_{id} = 100mV, V_O = V_{DD}$	2	47		mA
	Output sink current	$V_{id} = -100mV, V_O = V_{CC}$	2	47		
I_{CC}	Supply current (per amplifier)	$V_{out} = V_{CC}/2$ $A_{VCL} = 1$, no load $T_{min} \leq T_{amb} \leq T_{max}$		150	200 230	μA
GBP	Gain bandwidth product	$R_L = 10k\Omega, C_L = 100pF, f = 100kHz$	370	600		kHz
SR	Slew rate	$R_L = 10k\Omega, C_L = 100pF, A_V = 1$	0.12	0.2		$V/\mu s$
ϕ_m	Phase margin	$C_L = 100pF$		60		Degrees
en	Input voltage noise	$f = 1kHz$		40		nV/\sqrt{Hz}
THD	Total harmonic distortion	$V_{out}=2V_{pk-pk}, A_V = -1, f = 1kHz$		0.005		%

1. All parameter limits at temperatures other than $25^\circ C$ are guaranteed by correlation.

2. Maximum values include unavoidable inaccuracies of the industrial tests.

Table 5. Electrical characteristics measured at $V_{CC} = +5V$, $V_{dd} = 0V$, with C_L & R_L connected to $V_{CC}/2$, $T_{amb} = 25^\circ C$ (unless otherwise specified) ⁽¹⁾

Symbol	Parameter	Conditions	Min.	Typ.	Max.	Unit
V_{io}	Input offset voltage	$V_{icm} = V_{out} = V_{CC}/2$ TS1851/2/4 $T_{min} \leq T_{amb} \leq T_{max}$ TS1851A/2A/4A $T_{min} \leq T_{amb} \leq T_{max}$		0.1	3 6 1 1.5	mV
ΔV_{io}	Input offset voltage drift			2		$\mu V/^\circ C$
I_{io}	Input offset current	$V_{icm} = V_{out} = V_{CC}/2^{(2)}$ $T_{min} \leq T_{amb} \leq T_{max}$		1	9 25	nA
I_{ib}	Input bias current	$V_{icm} = V_{out} = V_{CC}/2^{(2)}$ $T_{min} \leq T_{amb} \leq T_{max}$		16	63 93	nA
CMR	Common mode rejection ratio $20 \log (\Delta V_{ic}/\Delta V_{io})$	$0 \leq V_{icm} \leq V_{CC}$ $T_{min} \leq T_{amb} \leq T_{max}$	65 62	95		dB
SVR	Supply voltage rejection ratio $20 \log (\Delta V_{CC}/\Delta V_{io})$	$V_{CC} = 1.8$ to $5V$	70	90		dB
A_{vd}	Large signal voltage gain	$V_{out} = 0.5V$ to $4V$ $R_L = 10k\Omega$ $R_L = 2k\Omega$	85 77	97 93		dB
V_{OH}	High level output voltage	$V_{id} = 100mV$ $R_L = 10k\Omega$ $R_L = 2k\Omega$ $T_{min} \leq T_{amb} \leq T_{max}$, $R_L = 10k\Omega$ $T_{min} \leq T_{amb} \leq T_{max}$, $R_L = 2k\Omega$	4.85 4.8 4.85 4.8	4.95 4.91		V
V_{OL}	Low level output voltage	$V_{id} = -100mV$ $R_L = 10k\Omega$ $R_L = 2k\Omega$ $T_{min} \leq T_{amb} \leq T_{max}$, $R_L = 10k\Omega$ $T_{min} \leq T_{amb} \leq T_{max}$, $R_L = 2k\Omega$		40 80	180 200 180 200	mV
I_o	Output source current	$V_{id} = 100mV$, $V_O = V_{DD}$	2	48		mA
	Output sink current	$V_{id} = -100mV$, $V_O = V_{CC}$	2	48		
I_{CC}	Supply current (per amplifier)	$V_{out} = V_{CC}/2$ $A_{VCL} = 1$, no load $T_{min} \leq T_{amb} \leq T_{max}$		162	220 250	μA
GBP	Gain bandwidth product	$R_L = 10k\Omega$, $C_L = 100pF$, $f = 100kHz$	380	630		kHz
SR	Slew rate	$R_L = 10k\Omega$, $C_L = 100pF$, $A_V = 1$	0.13	0.25		$V/\mu s$
ϕ_m	Phase margin	$C_L = 100pF$		60		Degrees
en	Input voltage noise	$f = 1kHz$		40		nV/\sqrt{Hz}
THD	Total harmonic distortion	$V_{out} = 2V_{pk-pk}$, $A_V = -1$, $f = 1kHz$		0.01		%

1. All parameter limits at temperatures other than $25^\circ C$ are guaranteed by correlation.
2. Maximum values include unavoidable inaccuracies of the industrial tests.

Figure 1. Input offset voltage distribution

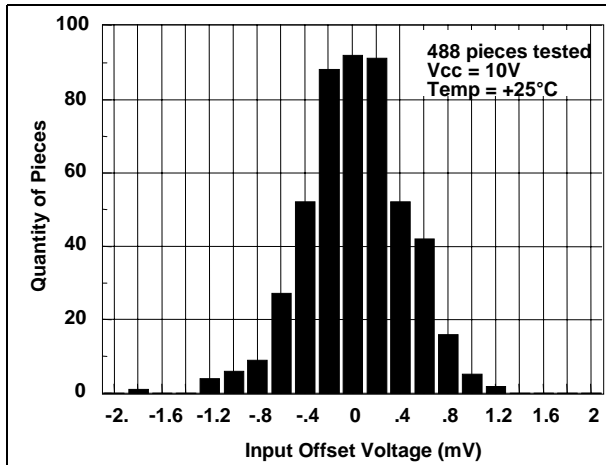

Figure 2. Input offset voltage vs. temperature

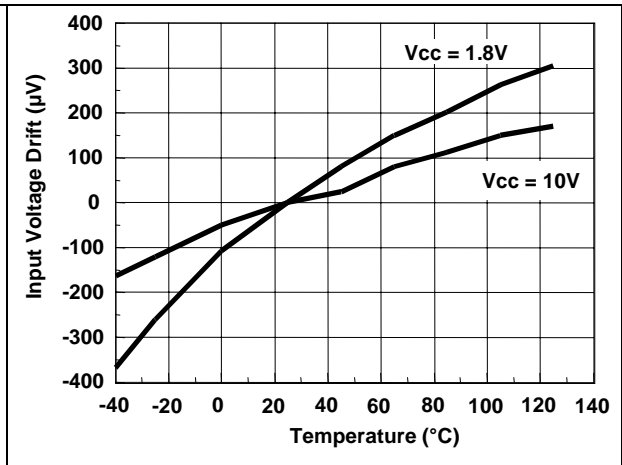

Figure 3. Input bias current vs. temperature

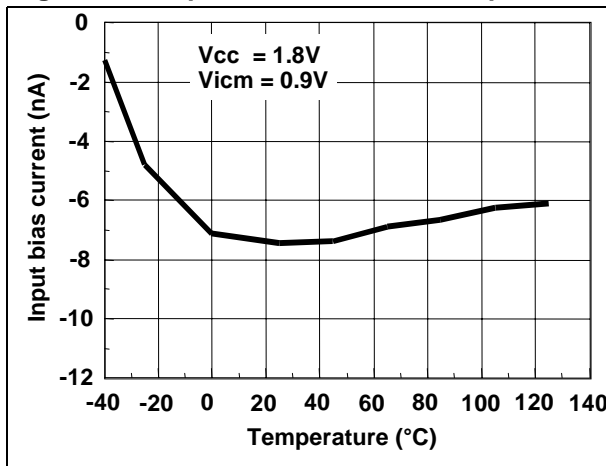

Figure 4. Input bias current vs. temperature

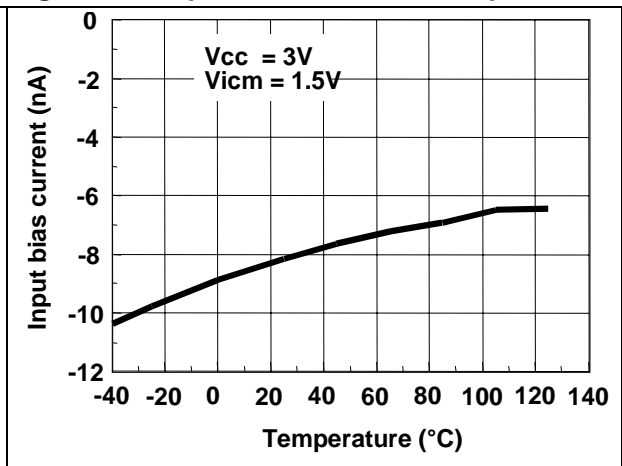

Figure 5. Input bias current vs. temperature

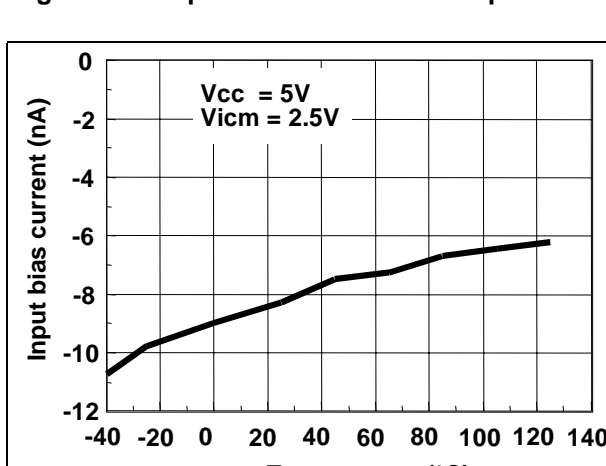

Figure 6. Supply current/amplifier vs. supply voltage

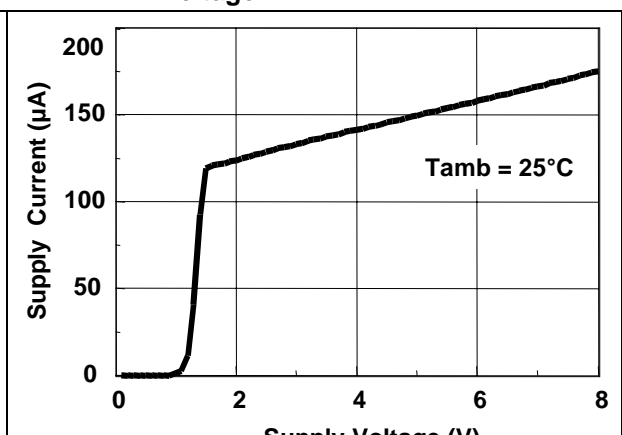

Figure 7. Supply current/amplifier vs. temperature

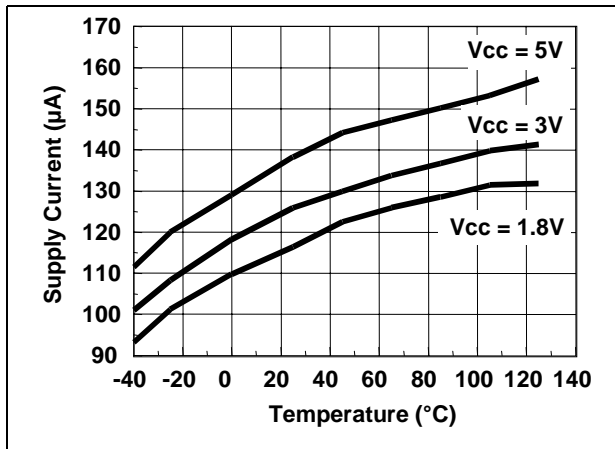

Figure 8. Common mode rejection vs. temperature

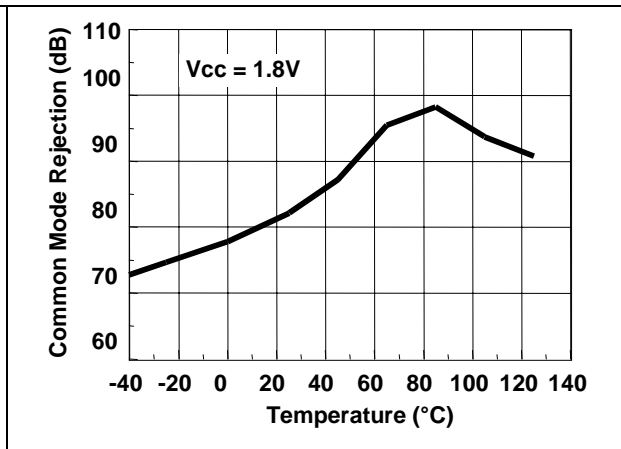

Figure 9. Common mode rejection vs. temperature

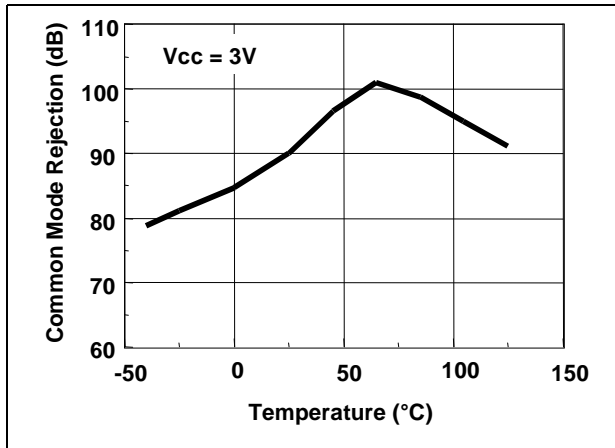

Figure 10. Gain and phasis vs. frequency

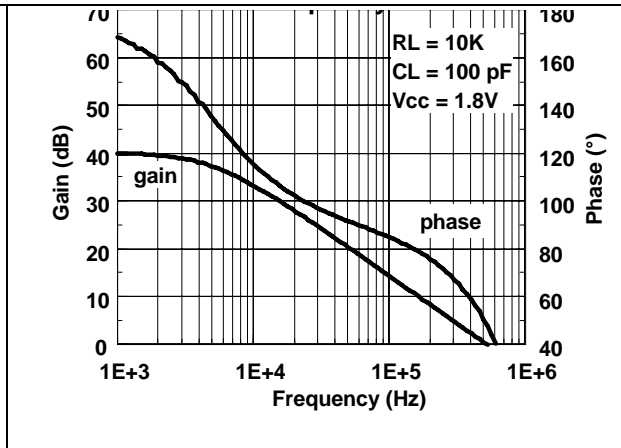

Figure 11. Supply voltage rejection vs. temperature

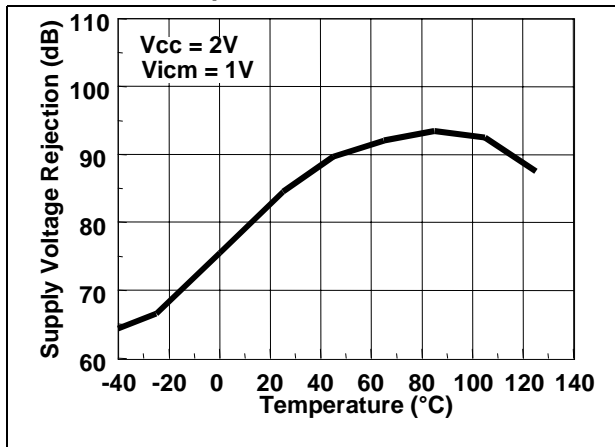

Figure 12. Gain and phasis vs. frequency

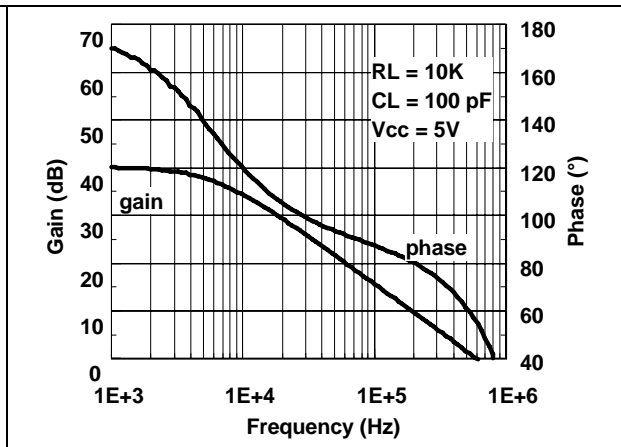

Figure 13. Common mode rejection vs. temperature

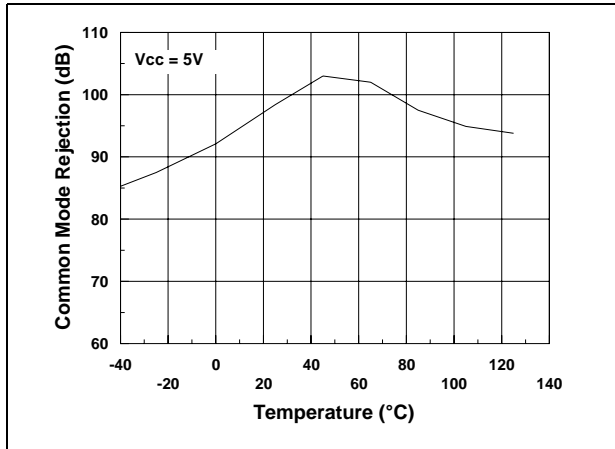

Figure 14. Supply voltage rejection vs. temperature

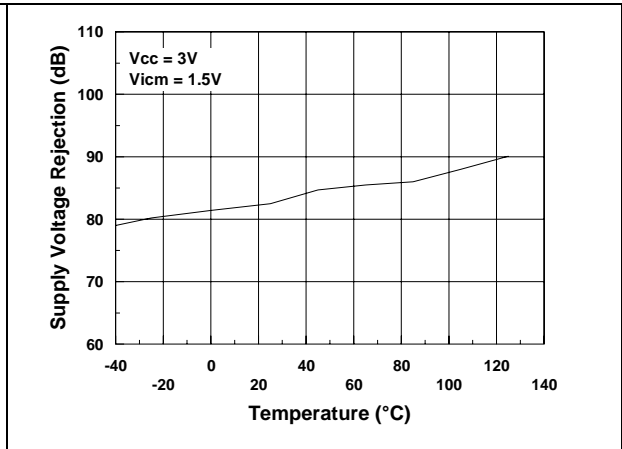

Figure 15. Supply voltage rejection vs. temperature

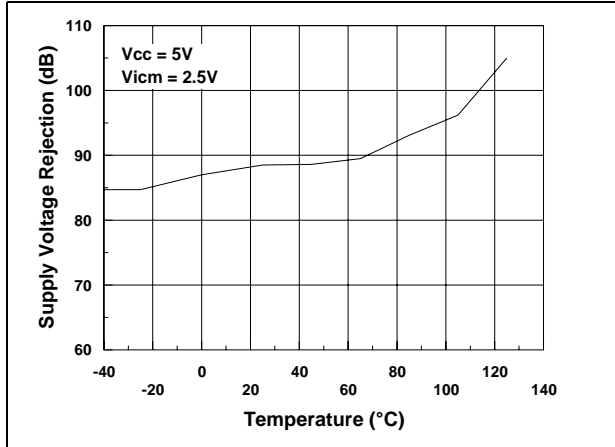

Figure 16. Open loop gain vs. temperature

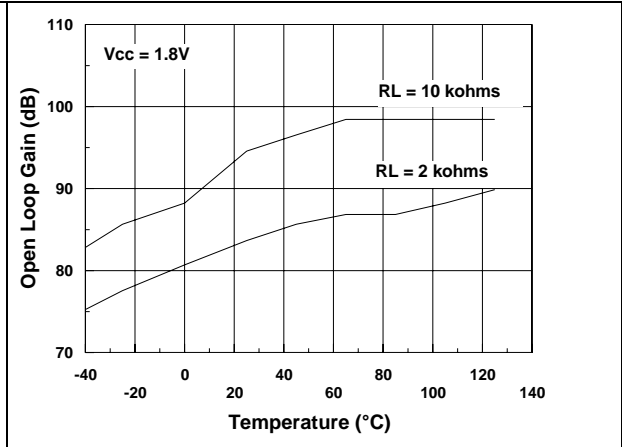

Figure 17. Open loop gain vs. temperature

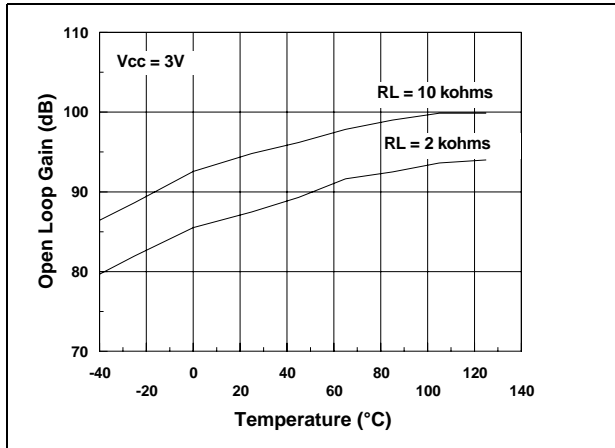

Figure 18. Open loop gain vs. temperature

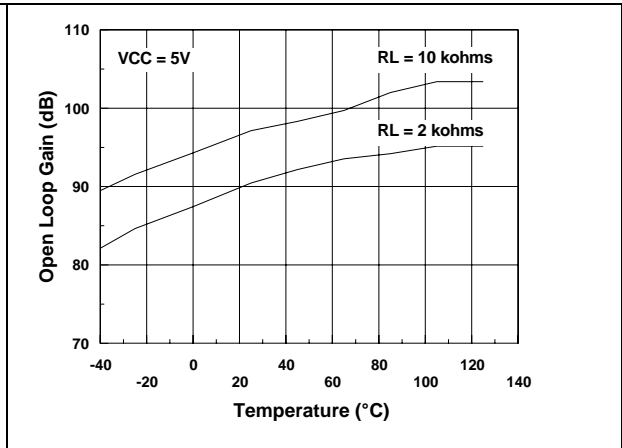

Figure 19. High level output voltage vs. temperature

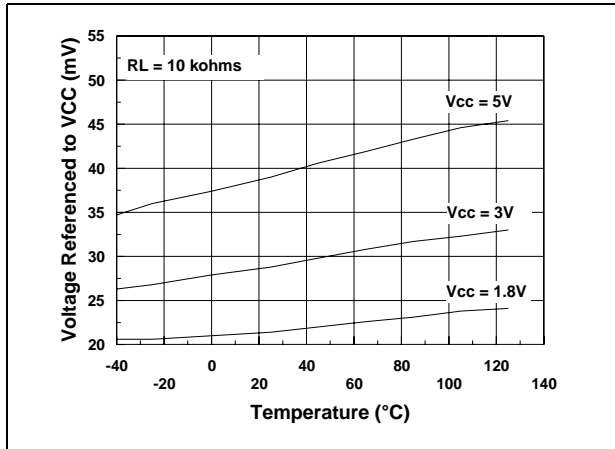

Figure 20. Low level output voltage vs. temperature

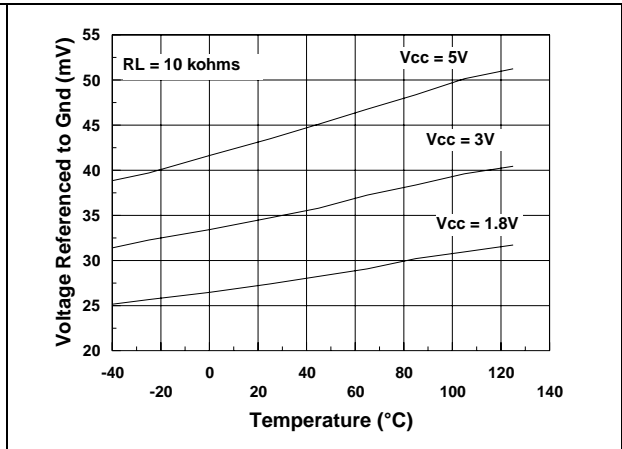

Figure 21. High level output voltage vs. temperature

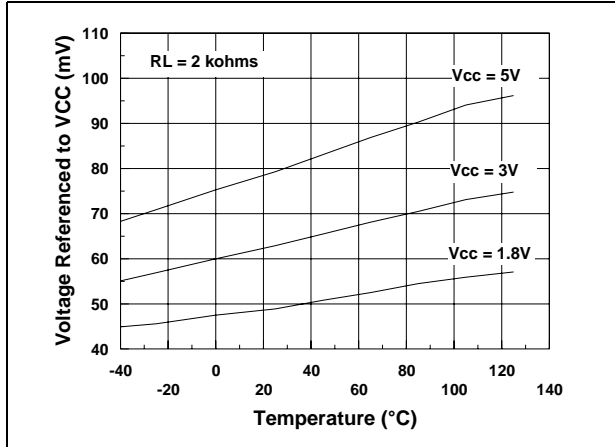

Figure 22. Low level output voltage vs. temperature

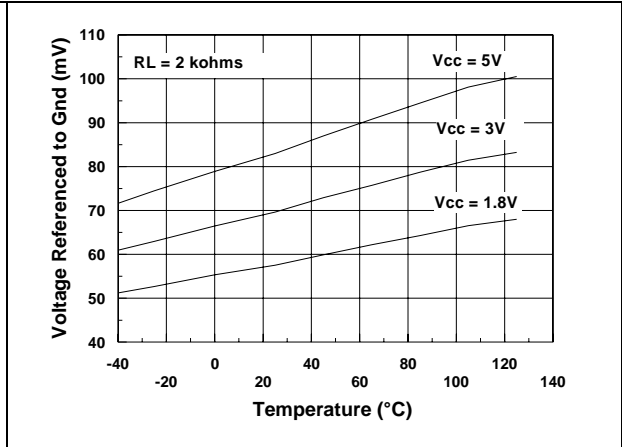

Figure 23. Output current vs. temperature

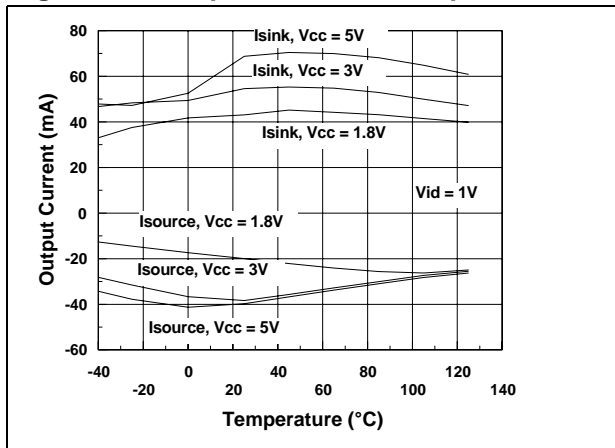

Figure 24. Output current vs. temperature

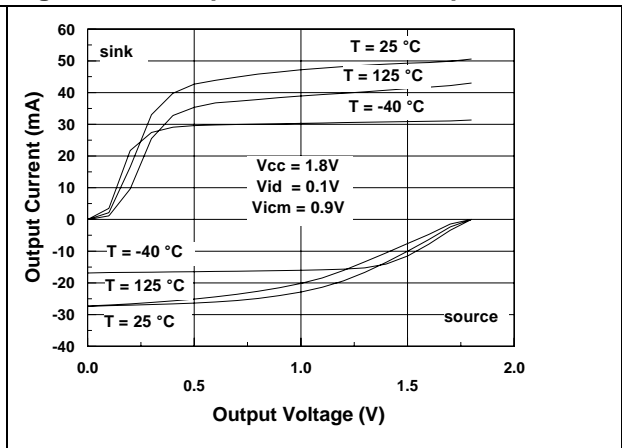

Figure 25. Output current vs. output voltage

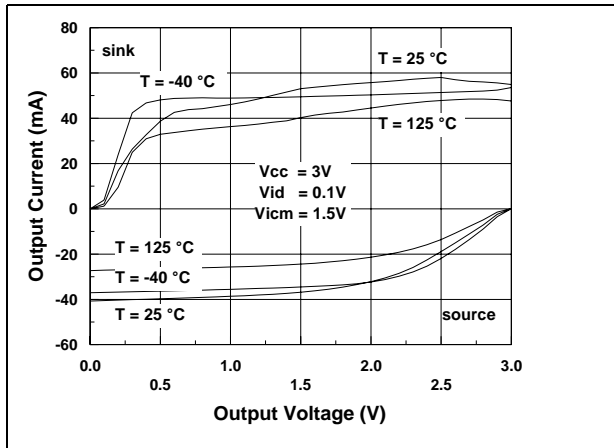

Figure 26. Output current vs. output voltage

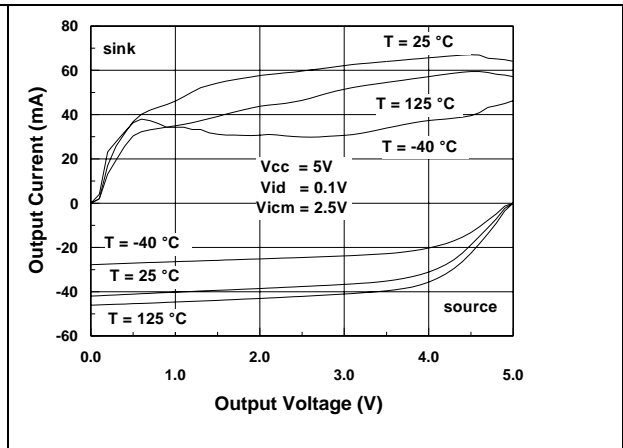

Figure 27. Gain and phasis vs. frequency

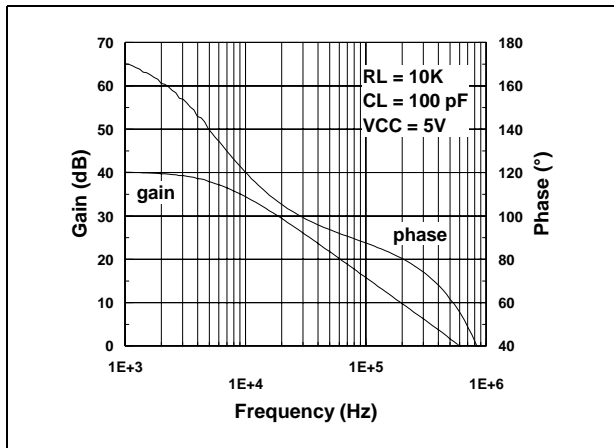

Figure 28. Gain bandwidth product vs. temperature

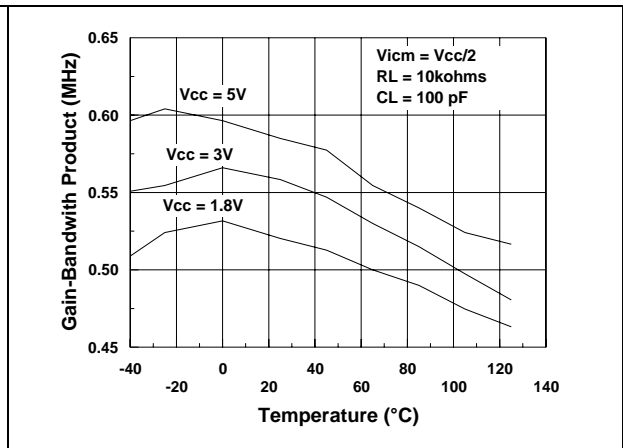

Figure 29. Gain bandwidth product vs. supply voltage

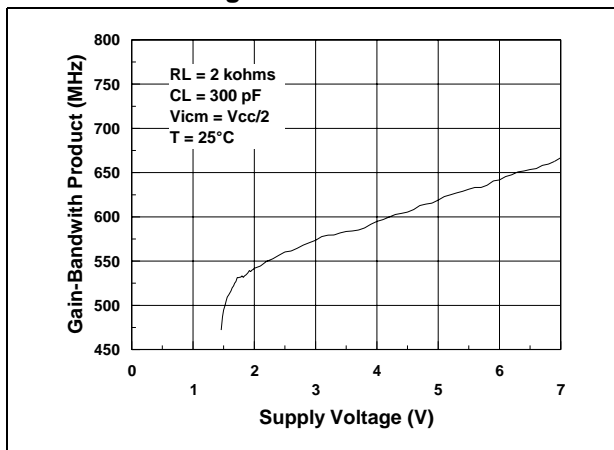

Figure 30. Slew rate vs. temperature

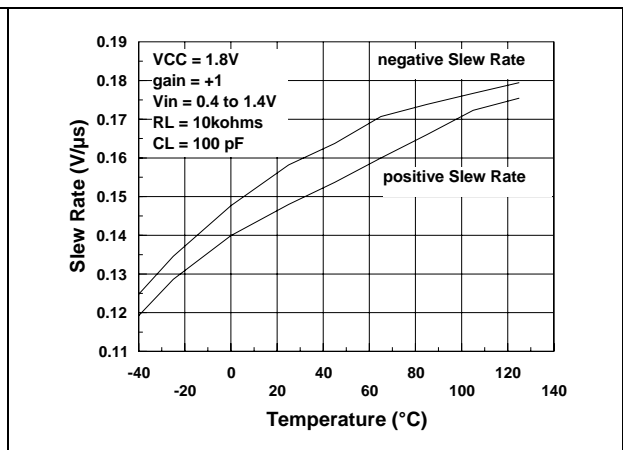

Figure 31. Slew rate vs. temperature

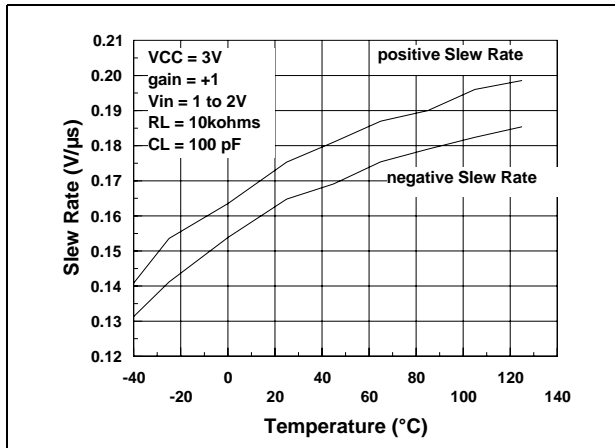

Figure 32. Slew rate vs. temperature

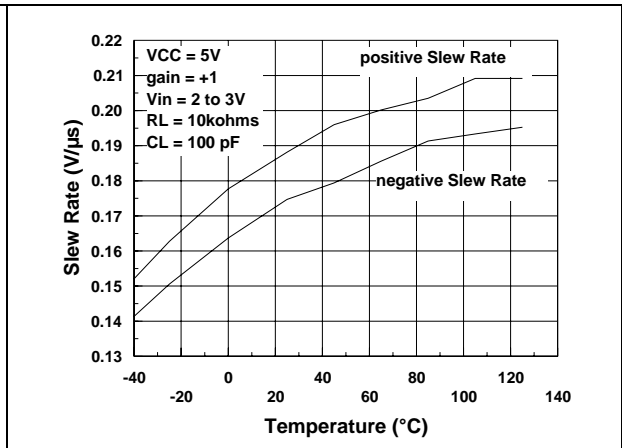

Figure 33. Phase margin vs. load capacitor

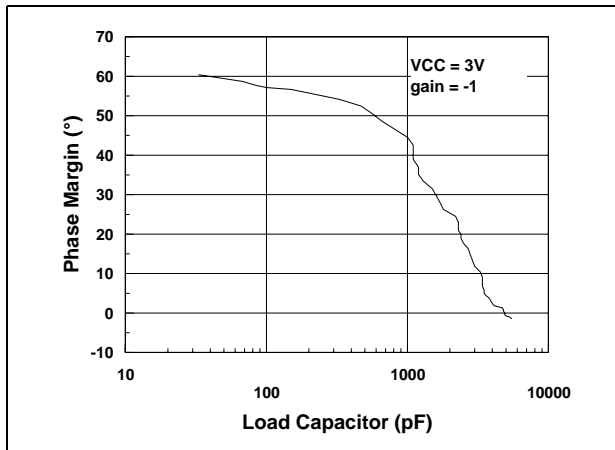

Figure 34. Phase margin vs. output current

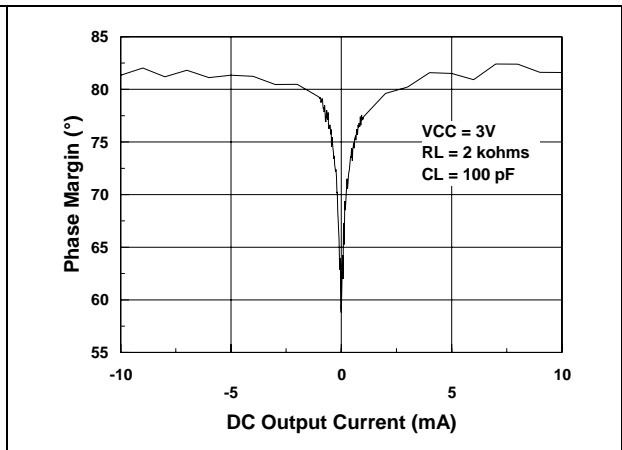

Figure 35. Equivalent input noise vs. frequency

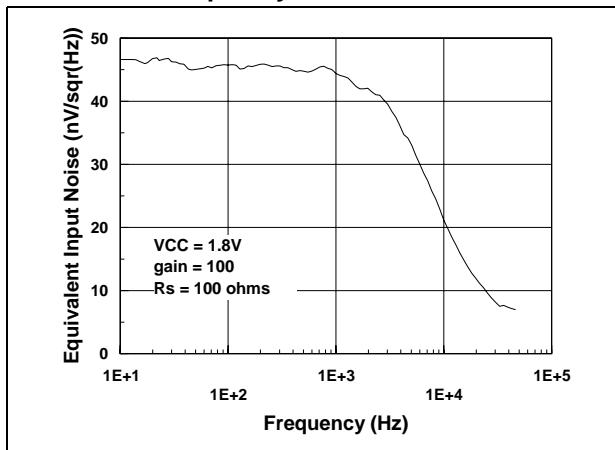

Figure 36. Distortion vs. output voltage

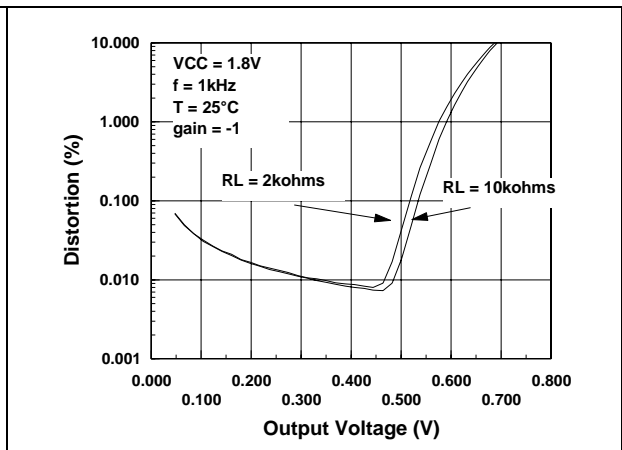

Figure 37. Distortion vs. output voltage

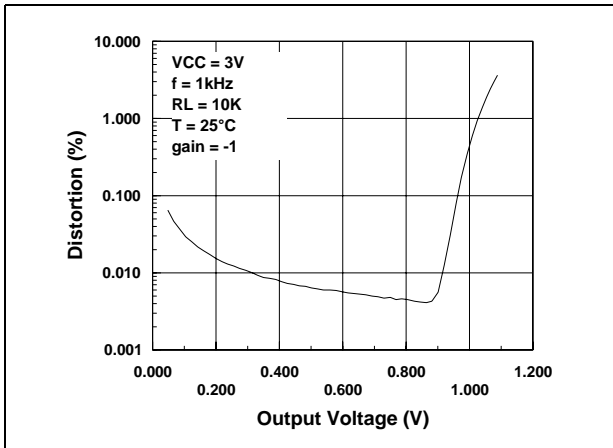

Figure 38. Distortion vs. output voltage

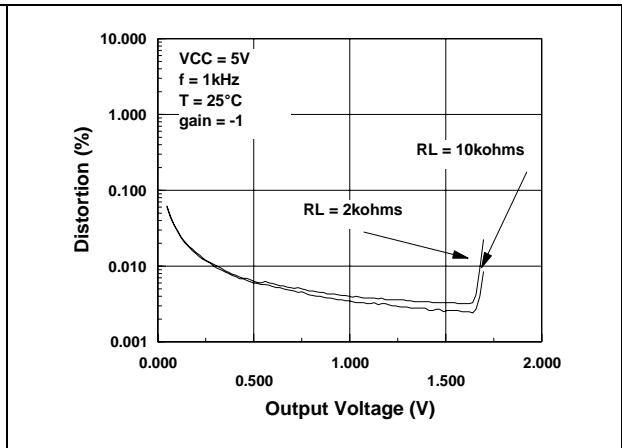
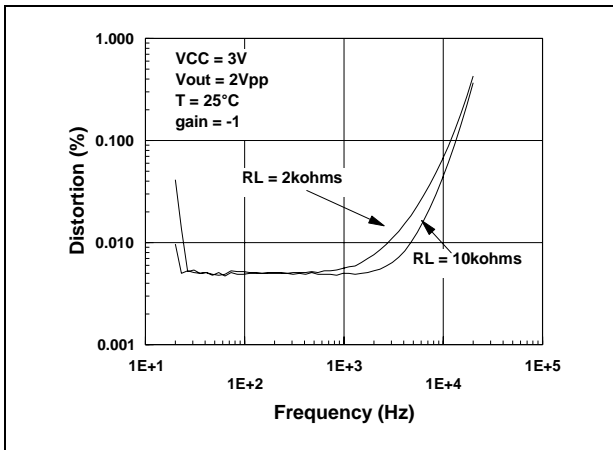

Figure 39. Distortion vs. frequency



4 Package information

In order to meet environmental requirements, STMicroelectronics offers these devices in ECOPACK[®] packages. These packages have a lead-free second level interconnect. The category of second level interconnect is marked on the package and on the inner box label, in compliance with JEDEC Standard JESD97. The maximum ratings related to soldering conditions are also marked on the inner box label. ECOPACK is an STMicroelectronics trademark. ECOPACK specifications are available at: www.st.com.

4.1 DIP8 package mechanical data

Ref.	Dimensions					
	Millimeters			Inches		
	Min.	Typ.	Max.	Min.	Typ.	Max.
A			5.33			0.210
A1	0.38			0.015		
A2	2.92	3.30	4.95	0.115	0.130	0.195
b	0.36	0.46	0.56	0.014	0.018	0.022
b2	1.14	1.52	1.78	0.045	0.060	0.070
c	0.20	0.25	0.36	0.008	0.010	0.014
D	9.02	9.27	10.16	0.355	0.365	0.400
E	7.62	7.87	8.26	0.300	0.310	0.325
E1	6.10	6.35	7.11	0.240	0.250	0.280
e		2.54			0.100	
eA		7.62			0.300	
eB			10.92			0.430
L	2.92	3.30	3.81	0.115	0.130	0.150

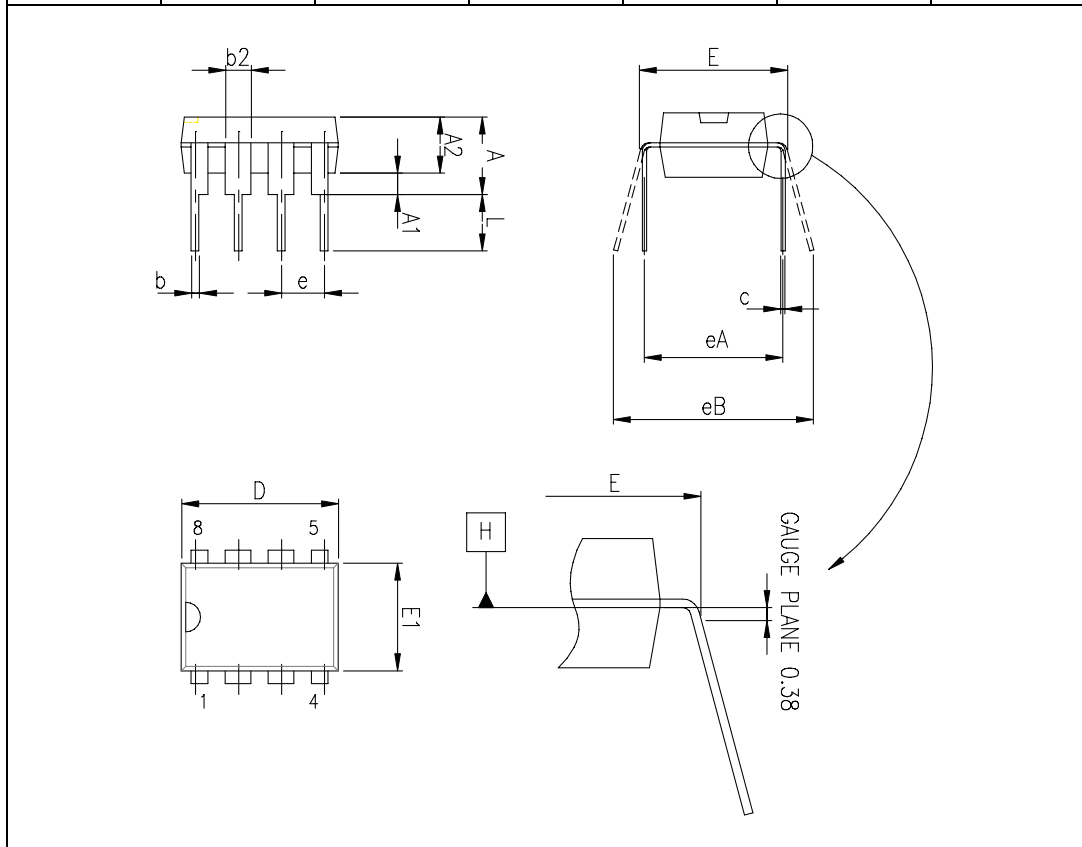

4.2 SO-8 package mechanical data

Ref.	Dimensions					
	Millimeters			Inches		
	Min.	Typ.	Max.	Min.	Typ.	Max.
A			1.75			0.069
A1	0.10		0.25	0.004		0.010
A2	1.25			0.049		
b	0.28		0.48	0.011		0.019
c	0.17		0.23	0.007		0.010
D	4.80	4.90	5.00	0.189	0.193	0.197
H	5.80	6.00	6.20	0.228	0.236	0.244
E1	3.80	3.90	4.00	0.150	0.154	0.157
e		1.27			0.050	
h	0.25		0.50	0.010		0.020
L	0.40		1.27	0.016		0.050
k	1°		8°	1°		8°
ccc			0.10			0.004

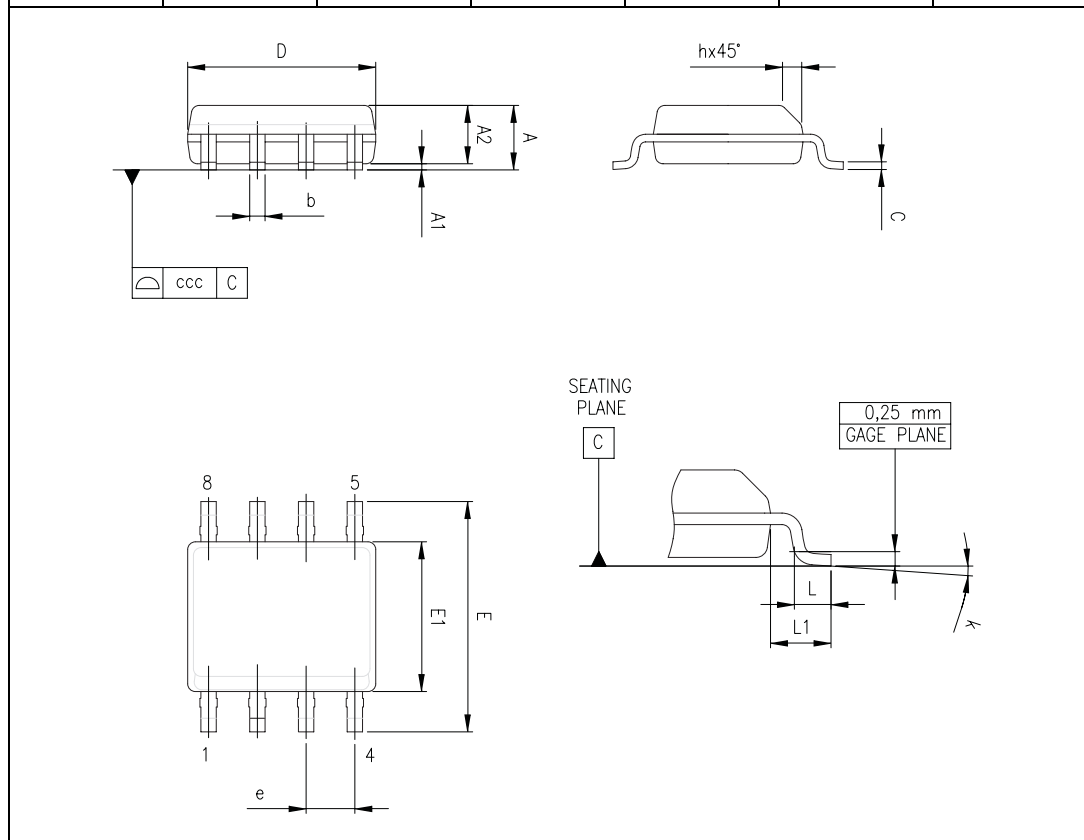

4.3 TSSOP8 package mechanical data

Ref.	Dimensions					
	Millimeters			Inches		
	Min.	Typ.	Max.	Min.	Typ.	Max.
A			1.2			0.047
A1	0.05		0.15	0.002		0.006
A2	0.80	1.00	1.05	0.031	0.039	0.041
b	0.19		0.30	0.007		0.012
c	0.09		0.20	0.004		0.008
D	2.90	3.00	3.10	0.114	0.118	0.122
E	6.20	6.40	6.60	0.244	0.252	0.260
E1	4.30	4.40	4.50	0.169	0.173	0.177
e		0.65			0.0256	
k	0°		8°	0°		8°
L	0.45	0.60	0.75	0.018	0.024	0.030
L1		1			0.039	
aaa		0.1			0.004	

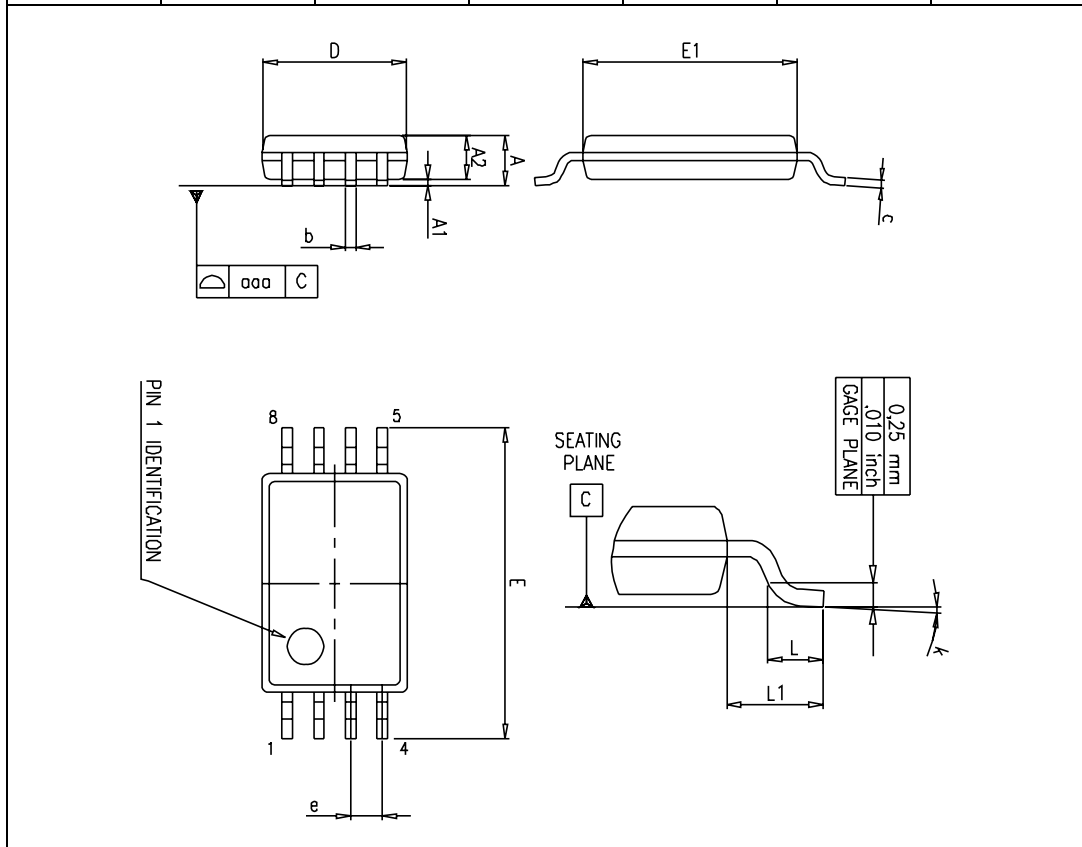

4.4 MiniSO-8 package mechanical data

Ref.	Dimensions					
	Millimeters			Inches		
	Min.	Typ.	Max.	Min.	Typ.	Max.
A			1.1			0.043
A1	0.05	0.10	0.15	0.002	0.004	0.006
A2	0.78	0.86	0.94	0.031	0.034	0.037
b	0.25	0.33	0.40	0.010	0.013	0.016
c	0.13	0.18	0.23	0.005	0.007	0.009
D	2.90	3.00	3.10	0.114	0.118	0.122
E	4.75	4.90	5.05	0.187	0.193	0.199
E1	2.90	3.00	3.10	0.114	0.118	0.122
e		0.65			0.026	
K	0°		6°	0°		6°
L	0.40	0.55	0.70	0.016	0.022	0.028
L1			0.10			0.004

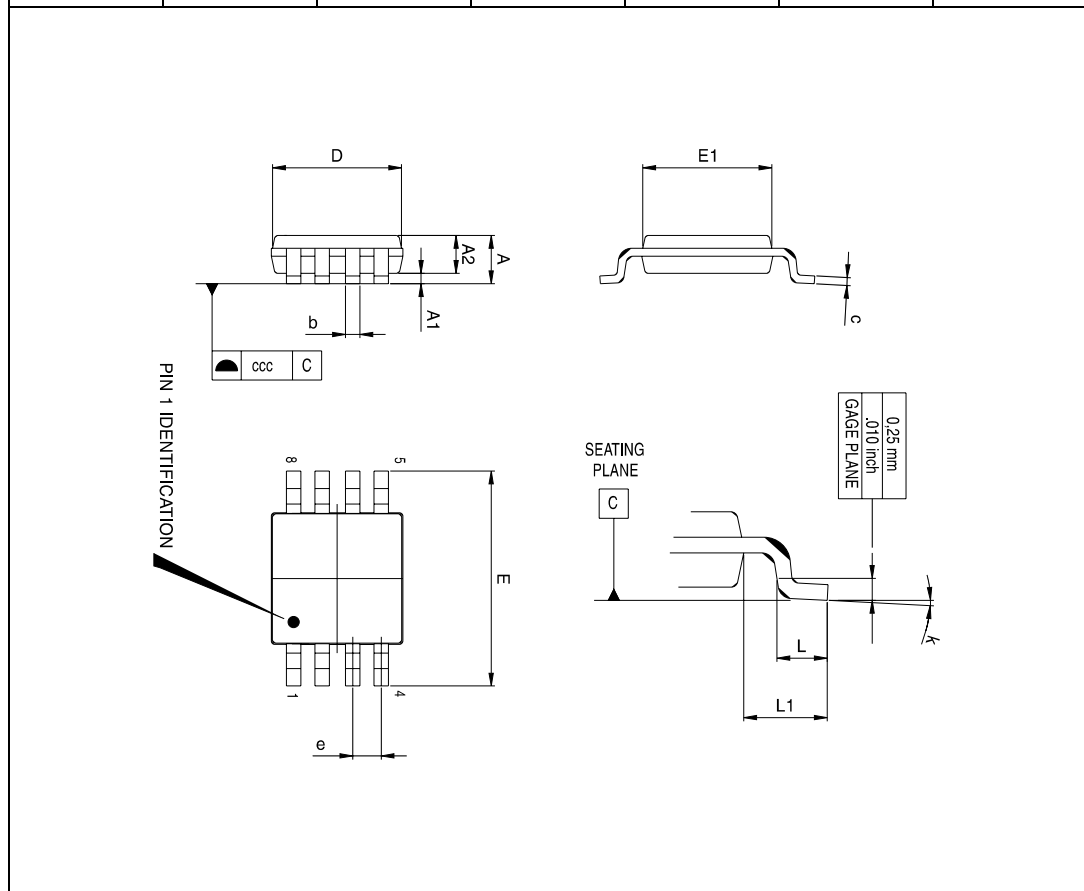

4.5 DIP14 package mechanical data

Ref.	Dimensions					
	Millimeters			Inches		
	Min.	Typ.	Max.	Min.	Typ.	Max.
a1	0.51			0.020		
B	1.39		1.65	0.055		0.065
b		0.5			0.020	
b1		0.25			0.010	
D			20			0.787
E		8.5			0.335	
e		2.54			0.100	
e3		15.24			0.600	
F			7.1			0.280
l			5.1			0.201
L		3.3			0.130	
Z	1.27		2.54	0.050		0.100

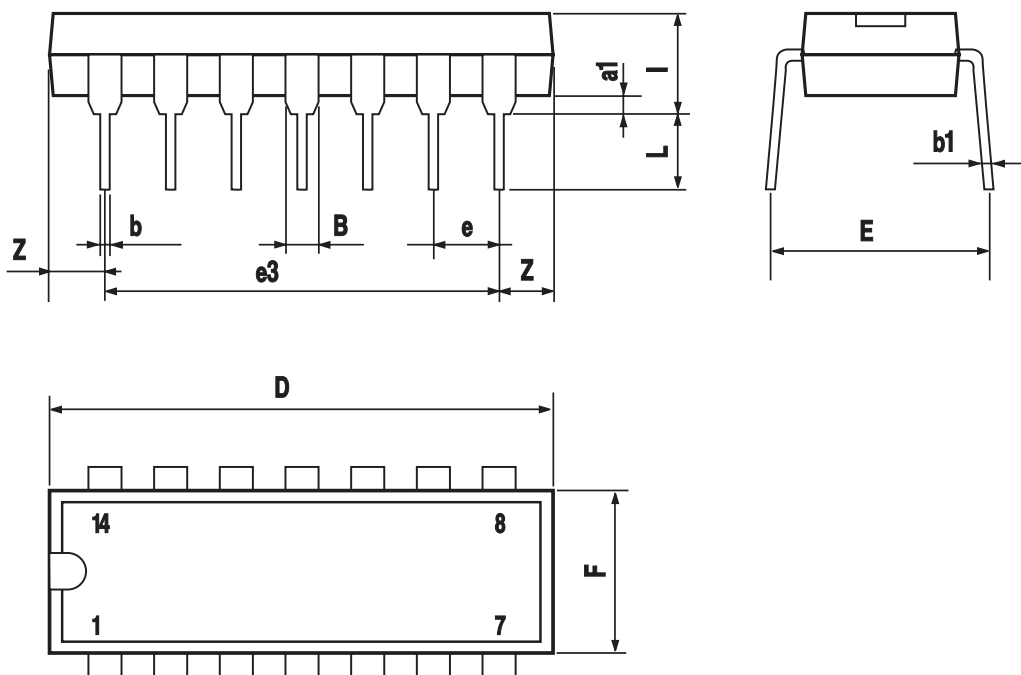

4.6 SO-14 package mechanical data

Ref.	Dimensions					
	Millimeters			Inches		
	Min.	Typ.	Max.	Min.	Typ.	Max.
A			1.75			0.068
a1	0.1		0.2	0.003		0.007
a2			1.65			0.064
b	0.35		0.46	0.013		0.018
b1	0.19		0.25	0.007		0.010
C		0.5			0.019	
c1	45° (typ.)					
D	8.55		8.75	0.336		0.344
E	5.8		6.2	0.228		0.244
e		1.27			0.050	
e3		7.62			0.300	
F	3.8		4.0	0.149		0.157
G	4.6		5.3	0.181		0.208
L	0.5		1.27	0.019		0.050
M			0.68			0.026
S	8° (max.)					

4.7 TSSOP14 package mechanical data

Ref.	Dimensions					
	Millimeters			Inches		
	Min.	Typ.	Max.	Min.	Typ.	Max.
A			1.2			0.047
A1	0.05		0.15	0.002	0.004	0.006
A2	0.8	1	1.05	0.031	0.039	0.041
b	0.19		0.30	0.007		0.012
c	0.09		0.20	0.004		0.0089
D	4.9	5	5.1	0.193	0.197	0.201
E	6.2	6.4	6.6	0.244	0.252	0.260
E1	4.3	4.4	4.48	0.169	0.173	0.176
e		0.65 BSC			0.0256 BSC	
K	0°		8°	0°		8°
L	0.45	0.60	0.75	0.018	0.024	0.030

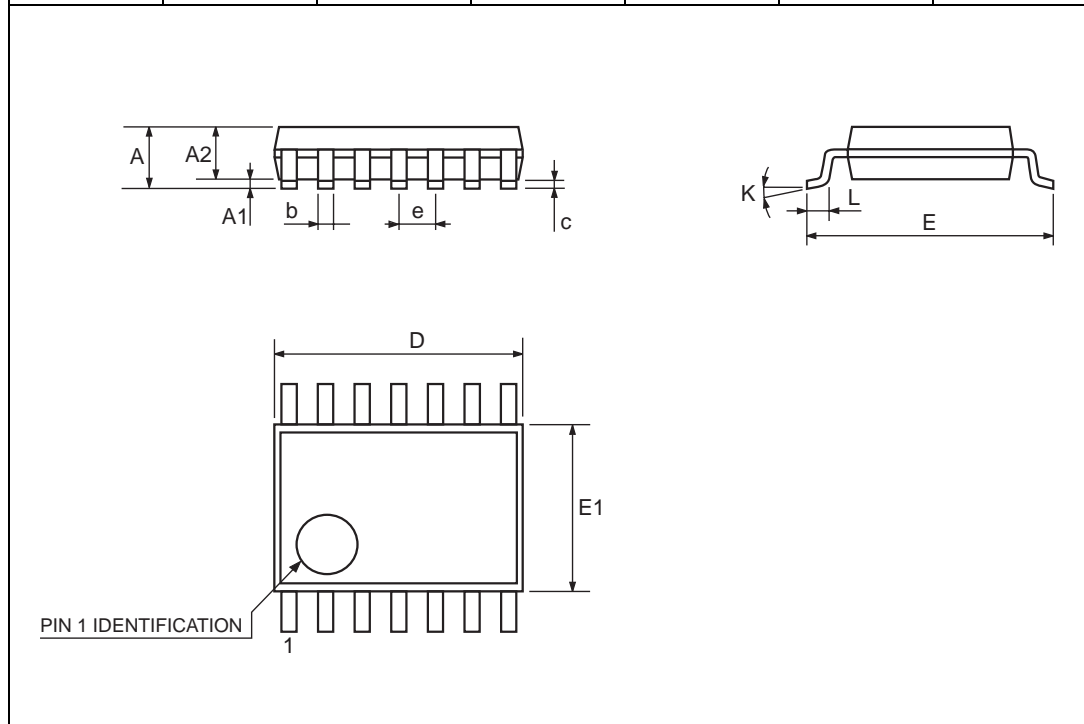

4.8 SOT23-5 package mechanical data

Ref.	Dimensions					
	Millimeters			Mils		
	Min.	Typ.	Max.	Min.	Typ.	Max.
A	0.890		1.120	35.05		44.12
A1	0.010		0.100	0.39		3.94
A2	0.880	0.950	1.020	34.65	37.41	40.17
b	0.300		0.500	11.81		19.69
C	0.080		0.200	3.15		7.88
D	2.800	2.900	3.040	110.26	114.17	119.72
E	2.100		2.64	82.70		103.96
E1	1.200	1.300	1.400	47.26	51.19	55.13
e		0.950			37.41	
e1		1.900			74.82	
L	0.400		0.600	15.75		23.63
L1		0.540			21.27	
k	0°		8°	0°		8°

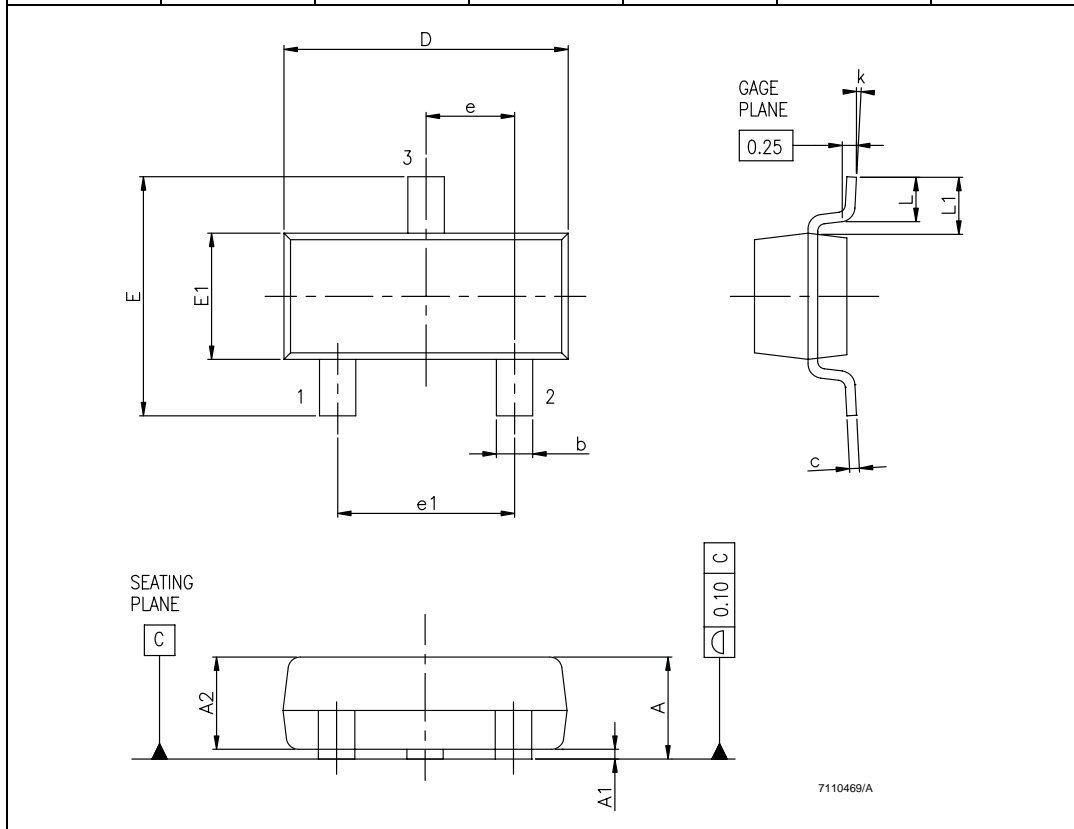

5 Ordering information

Table 6. Order codes

Part number	Temperature range	Package	Packing	Marking
TS1851ID/IDT	-40°C to +125°C	SO-8	Tube or Tape & reel	1851I
TS1851AID/AIDT				1851AI
TS1851ILT		SOT23-5L	Tape & reel	K161
TS1851AILT				K162
TS1852IN		DIP8	Tube	1852IN
TS1852AIN				1852AIN
TS1852ID/IDT		SO-8	Tube or Tape & reel	1852I
TS1852AID/AIDT				1852AI
TS1852IPT		TSSOP8 (Thin shrink outline package)	Tape & reel	1852I
TS1852AIPT				1852A
TS1852IST		MiniSO-8	Tape & reel	K161
TS1852AIST				K162
TS1854IN/AIN		DIP14	Tube	1854IN
TS1854ID/IDT		SO-14	Tube or Tape & reel	1854I
TS1854AID/AIDT				1854AI
TS1854IPT		TSSOP14 (Thin shrink outline package)	Tape & reel	1854I
TS1854AIPT				1854A

6 Revision history

Date	Revision	Changes
Feb-2002	1	First release.
May-2005	2	Modifications on AMR Table 1 on page 3 (explanation of V_{id} and V_i limits)
22-May-2007	3	Added limits in temperature in Table 3 , Table 4 , and Table 5 . Added SVR in Table 5 (SVR parameter removed from Table 3 and Table 4). Added equivalent input voltage noise in Table 3 , Table 4 , and Table 5 . Added R_{thjc} values in Table 1 on page 3 . Updated Table 6: Order codes .

Please Read Carefully:

Information in this document is provided solely in connection with ST products. STMicroelectronics NV and its subsidiaries ("ST") reserve the right to make changes, corrections, modifications or improvements, to this document, and the products and services described herein at any time, without notice.

All ST products are sold pursuant to ST's terms and conditions of sale.

Purchasers are solely responsible for the choice, selection and use of the ST products and services described herein, and ST assumes no liability whatsoever relating to the choice, selection or use of the ST products and services described herein.

No license, express or implied, by estoppel or otherwise, to any intellectual property rights is granted under this document. If any part of this document refers to any third party products or services it shall not be deemed a license grant by ST for the use of such third party products or services, or any intellectual property contained therein or considered as a warranty covering the use in any manner whatsoever of such third party products or services or any intellectual property contained therein.

UNLESS OTHERWISE SET FORTH IN ST'S TERMS AND CONDITIONS OF SALE ST DISCLAIMS ANY EXPRESS OR IMPLIED WARRANTY WITH RESPECT TO THE USE AND/OR SALE OF ST PRODUCTS INCLUDING WITHOUT LIMITATION IMPLIED WARRANTIES OF MERCHANTABILITY, FITNESS FOR A PARTICULAR PURPOSE (AND THEIR EQUIVALENTS UNDER THE LAWS OF ANY JURISDICTION), OR INFRINGEMENT OF ANY PATENT, COPYRIGHT OR OTHER INTELLECTUAL PROPERTY RIGHT.

UNLESS EXPRESSLY APPROVED IN WRITING BY AN AUTHORIZED ST REPRESENTATIVE, ST PRODUCTS ARE NOT RECOMMENDED, AUTHORIZED OR WARRANTED FOR USE IN MILITARY, AIR CRAFT, SPACE, LIFE SAVING, OR LIFE SUSTAINING APPLICATIONS, NOR IN PRODUCTS OR SYSTEMS WHERE FAILURE OR MALFUNCTION MAY RESULT IN PERSONAL INJURY, DEATH, OR SEVERE PROPERTY OR ENVIRONMENTAL DAMAGE. ST PRODUCTS WHICH ARE NOT SPECIFIED AS "AUTOMOTIVE GRADE" MAY ONLY BE USED IN AUTOMOTIVE APPLICATIONS AT USER'S OWN RISK.

Resale of ST products with provisions different from the statements and/or technical features set forth in this document shall immediately void any warranty granted by ST for the ST product or service described herein and shall not create or extend in any manner whatsoever, any liability of ST.

ST and the ST logo are trademarks or registered trademarks of ST in various countries.

Information in this document supersedes and replaces all information previously supplied.

The ST logo is a registered trademark of STMicroelectronics. All other names are the property of their respective owners.

© 2007 STMicroelectronics - All rights reserved

STMicroelectronics group of companies

Australia - Belgium - Brazil - Canada - China - Czech Republic - Finland - France - Germany - Hong Kong - India - Israel - Italy - Japan - Malaysia - Malta - Morocco - Singapore - Spain - Sweden - Switzerland - United Kingdom - United States of America

www.st.com

