

MCR703A Series

Preferred Device

Sensitive Gate Silicon Controlled Rectifiers

Reverse Blocking Thyristors

PNPN devices designed for high volume, low cost consumer applications such as temperature, light and speed control; process and remote control; and warning systems where reliability of operation is critical.

Features

- Pb-Free Package is Available
- Small Size
- Passivated Die Surface for Reliability and Uniformity
- Low Level Triggering and Holding Characteristics
- Recommend Electrical Replacement for C106
- Surface Mount Package – Case 369C
- To Obtain “DPAK” in Straight Lead Version (Shipped in Sleeves):
– Add '1' Suffix to Device Number, i.e., MCR706A1
- Epoxy Meets UL 94, V-0 @ 0.125 in
- ESD Ratings: Human Body Model, 3B > 8000 V
Machine Model, C > 400 V



ON Semiconductor®

<http://onsemi.com>

SCRs
4.0 AMPERES RMS
100 – 600 VOLTS



MARKING DIAGRAMS

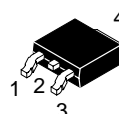

DPAK
CASE 369C
STYLE 2

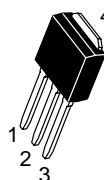
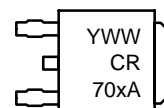

DPAK-3
CASE 369D
STYLE 2

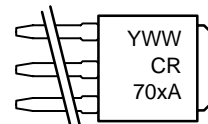

Y = Year
WW = Work Week
x = 3, 6, or 8

PIN ASSIGNMENT

PIN ASSIGNMENT	
1	Gate
2	Anode
3	Cathode
4	Anode

ORDERING INFORMATION

See detailed ordering and shipping information in the package dimensions section on page 3 of this data sheet.

Preferred devices are recommended choices for future use and best overall value.

MCR703A Series

MAXIMUM RATINGS (T_J = 25°C unless otherwise noted)

Rating	Symbol	Max	Unit
Peak Repetitive Off-State Voltage (Note 1) (T _C = -40 to +110°C, Sine Wave, 50 to 60 Hz, Gate Open)	V _{DRM} , V _{RRM}	100 400 600	V
Peak Non-Repetitive Off-State Voltage (Sine Wave, 50 to 60 Hz, Gate Open, T _C = -40 to +110°C)	V _{RSM}	150 450 650	V
On-State RMS Current (180° Conduction Angles; T _C = 90°C)	I _{T(RMS)}	4.0	A
Average On-State Current (180° Conduction Angles) T _C = -40 to +90°C T _C = +100°C	I _{T(AV)}	2.6 1.6	A
Non-Repetitive Surge Current (1/2 Sine Wave, 60 Hz, T _J = 110°C) (1/2 Sine Wave, 1.5 ms, T _J = 110°C)	I _{TSM}	25 35	A
Circuit Fusing (t = 8.3 msec)	I ² t	2.6	A ² sec
Forward Peak Gate Power (Pulse Width ≤ 1.0 μsec, T _C = 90°C)	P _{GM}	0.5	W
Forward Average Gate Power (t = 8.3 msec, T _C = 90°C)	P _{G(AV)}	0.1	W
Forward Peak Gate Current (Pulse Width ≤ 1.0 μsec, T _C = 90°C)	I _{GM}	0.2	A
Operating Junction Temperature Range	T _J	-40 to +110	°C
Storage Temperature Range	T _{stg}	-40 to +150	°C

Maximum ratings are those values beyond which device damage can occur. Maximum ratings applied to the device are individual stress limit values (not normal operating conditions) and are not valid simultaneously. If these limits are exceeded, device functional operation is not implied, damage may occur and reliability may be affected.

1. V_{DRM} and V_{RRM} for all types can be applied on a continuous basis. Ratings apply for zero or negative gate voltage; however, positive gate voltage shall not be applied concurrent with negative potential on the anode. Blocking voltages shall not be tested with a constant current source such that the voltage ratings of the devices are exceeded.

THERMAL CHARACTERISTICS

Characteristic	Symbol	Max	Unit
Thermal Resistance, Junction-to-Case	R _{θJC}	8.33	°C/W
Thermal Resistance, Junction-to-Ambient (Note 2)	R _{θJA}	80	°C/W
Maximum Lead Temperature for Soldering Purposes 1/8" from Case for 10 Seconds	T _L	260	°C

2. Case 369C when surface mounted on minimum pad sizes recommended.

MCR703A Series

ELECTRICAL CHARACTERISTICS (T_C = 25°C unless otherwise noted)

Characteristic	Symbol	Min	Typ	Max	Unit
----------------	--------	-----	-----	-----	------

OFF CHARACTERISTICS

Peak Repetitive Forward or Reverse Blocking Current (V _{AK} = Rated V _{DRM} or V _{RPM} ; R _{GK} = 1 KΩ)	T _C = 25°C T _C = 110°C	I _{DRM} , I _{RPM}	–	–	10 200	μA
--	---	-------------------------------------	---	---	-----------	----

ON CHARACTERISTICS

Peak Forward "On" Voltage (I _{TM} = 8.2 A Peak, Pulse Width = 1 to 2 ms, 2% Duty Cycle)		V _{TM}	–	–	2.2	V
Gate Trigger Current (Continuous dc) (Note 3) (V _{AK} = 12 Vdc, R _L = 24 Ohms)	T _C = 25°C T _C = -40°C	I _{GT}	–	25	75 300	μA
Gate Trigger Voltage (Continuous dc) (Note 3) (V _{AK} = 12 Vdc, R _L = 24 Ohms)	T _C = 25°C T _C = -40°C	V _{GT}	–	–	0.8 1.0	V
Gate Non-Trigger Voltage (Note 3) (V _{AK} = 12 Vdc, R _L = 100 Ohms, T _C = 110°C)		V _{GD}	0.2	—	—	V
Holding Current (V _{AK} = 12 Vdc, Gate Open) (Initiating Current = 200 mA)	T _C = 25°C T _C = -40°C	I _H	–	–	5.0 10	mA
Peak Reverse Gate Blocking Voltage (I _{GR} = 10 μA)		V _{RGM}	10	12.5	18	V
Peak Reverse Gate Blocking Current (V _{GR} = 10 V)		I _{RGM}	–	–	1.2	μA
Total Turn-On Time (Source Voltage = 12 V, R _S = 6 kΩ) (I _{TM} = 8.2 A, I _{GT} = 2 mA, Rated V _{DRM}) (Rise Time = 20 ns, Pulse Width = 10 μs)		t _{gt}	–	2.0	–	μs

DYNAMIC CHARACTERISTICS

Critical Rate of Rise of Off-State Voltage (V _D = Rated V _{DRM} , R _{GK} = 1 kΩ, Exponential Waveform, T _C = 110°C)	dv/dt	–	10	–	V/μs
Repetitive Critical Rate of Rise of On-State Current (C _f = 60 Hz, I _{PK} = 30 A, PW = 100 μs, diG/dt = 1 A/μs)	di/dt	–	–	100	A/μs

3. R_{GK} current not included in measurement.

ORDERING INFORMATION

Device	Package Type	Package	Shipping†
MCR703AT4	DPAK	369C	2500 Tape & Reel
MCR706AT4	DPAK	369C	2500 Tape & Reel
MCR706AT4G	DPAK (Pb-Free)	369C	2500 Tape & Reel
MCR708A	DPAK	369C	2500 Tape & Reel
MCR708A1	DPAK-3	369D	75 Units / Rail
MCR708AT4	DPAK	369C	2500 Tape & Reel

†For information on tape and reel specifications, including part orientation and tape sizes, please refer to our Tape and Reel Packaging Specifications Brochure, BRD8011/D.

MCR703A Series

Voltage Current Characteristic of SCR

Symbol	Parameter
V_{DRM}	Peak Repetitive Off-State Forward Voltage
I_{DRM}	Peak Forward Blocking Current
V_{RRM}	Peak Repetitive Off-State Reverse Voltage
I_{RRM}	Peak Reverse Blocking Current
V_{TM}	Peak On-State Voltage
I_H	Holding Current

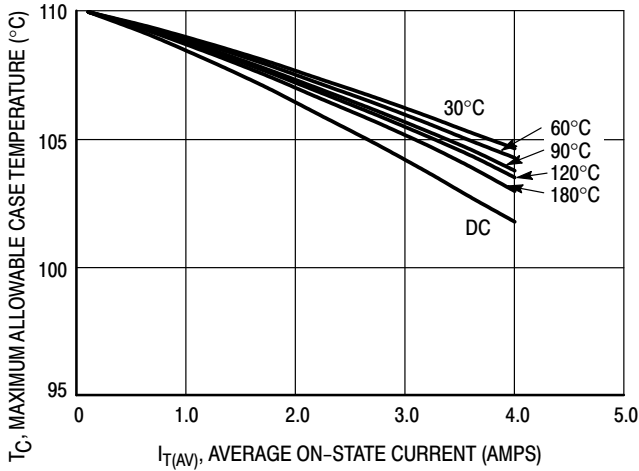
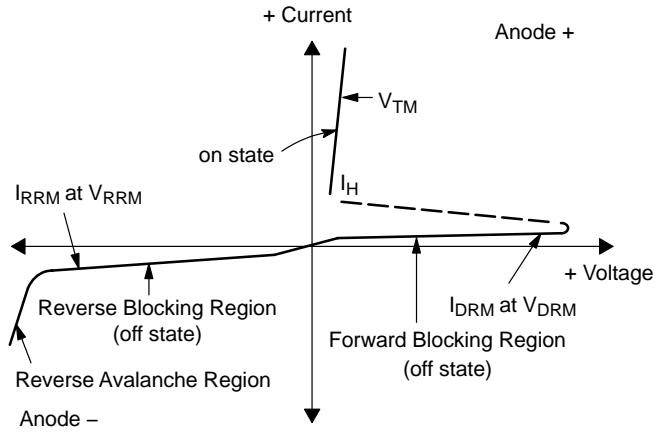

Figure 1. Average Current Derating

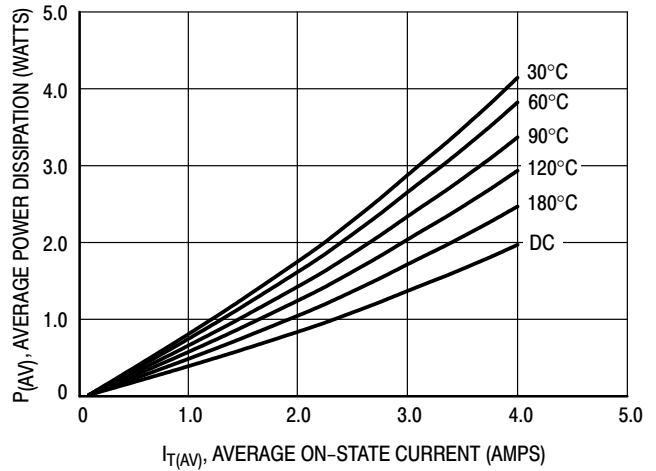

Figure 2. On-State Power Dissipation

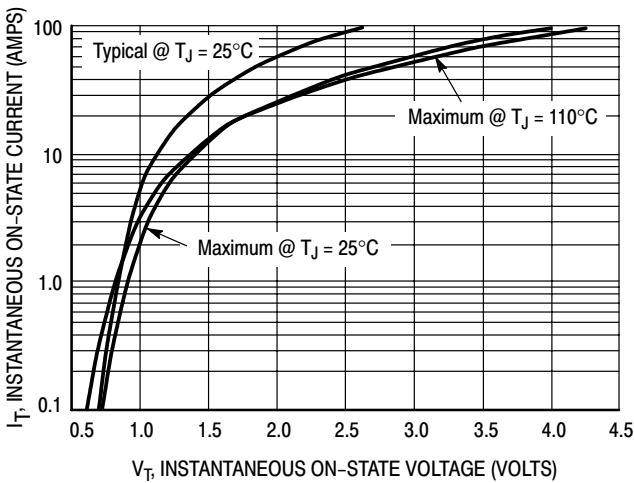

Figure 3. On-State Characteristics

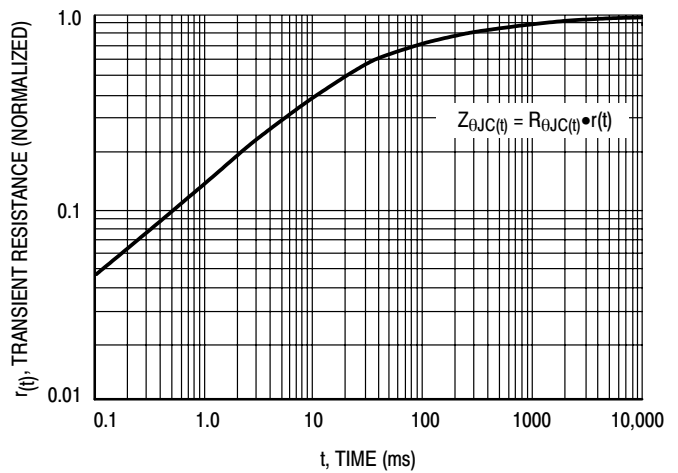

Figure 4. Transient Thermal Response

MCR703A Series

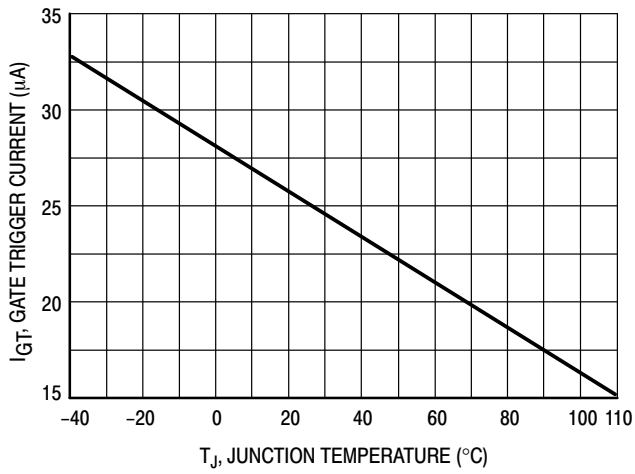

Figure 5. Typical Gate Trigger Current versus Junction Temperature

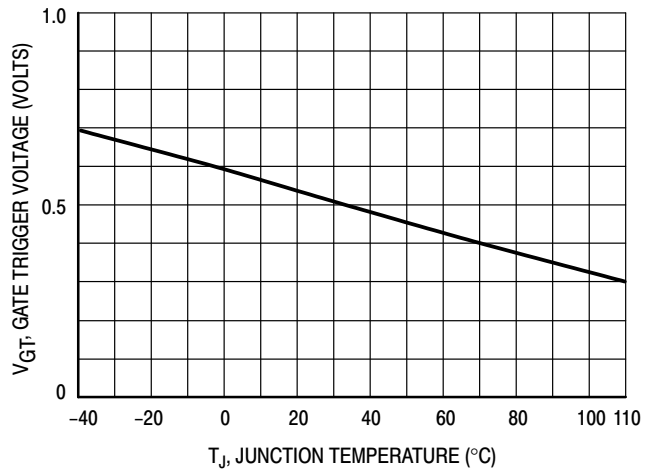

Figure 6. Typical Gate Trigger Voltage versus Junction Temperature

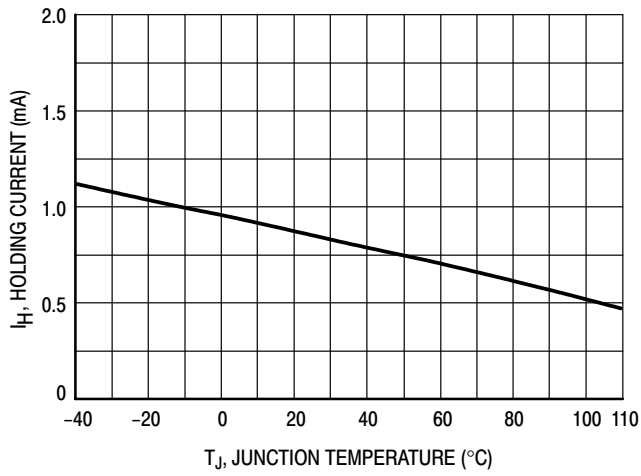

Figure 7. Typical Holding Current versus Junction Temperature

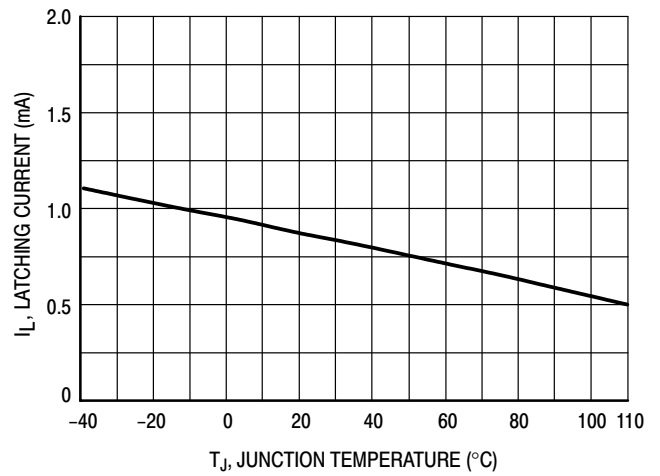
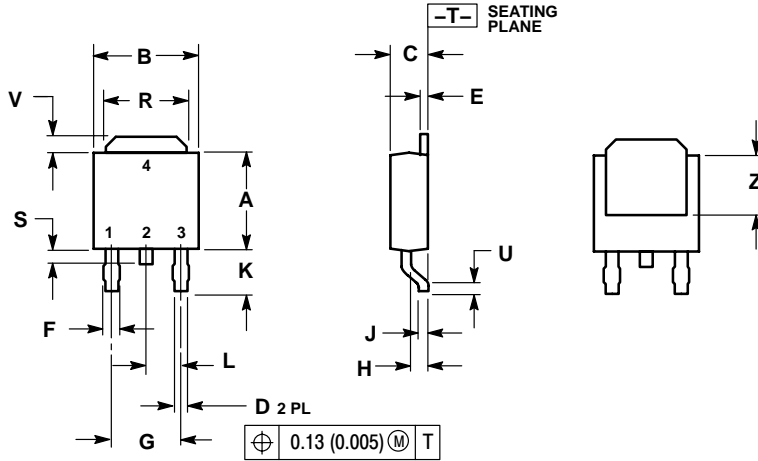

Figure 8. Typical Latching Current versus Junction Temperature

MCR703A Series

PACKAGE DIMENSIONS

DPAK
CASE 369C
ISSUE O



- NOTES:
1. DIMENSIONING AND TOLERANCING PER ANSI Y14.5M, 1982.
2. CONTROLLING DIMENSION: INCH.

DIM	INCHES		MILLIMETERS	
	MIN	MAX	MIN	MAX
A	0.235	0.245	5.97	6.22
B	0.250	0.265	6.35	6.73
C	0.086	0.094	2.19	2.38
D	0.027	0.035	0.69	0.88
E	0.018	0.023	0.46	0.58
F	0.037	0.045	0.94	1.14
G	0.180 BSC		4.58 BSC	
H	0.034	0.040	0.87	1.01
J	0.018	0.023	0.46	0.58
K	0.102	0.114	2.60	2.89
L	0.090 BSC		2.29 BSC	
R	0.180	0.215	4.57	5.45
S	0.025	0.040	0.63	1.01
U	0.020	---	0.51	---
V	0.035	0.050	0.89	1.27
Z	0.155	---	3.93	---

- STYLE 2:
PIN 1. GATE
2. DRAIN
3. SOURCE
4. DRAIN

SOLDERING FOOTPRINT*

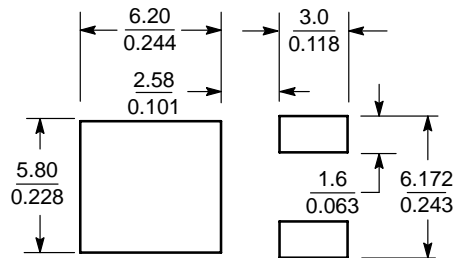

SCALE 3:1 $\left(\frac{\text{mm}}{\text{inches}} \right)$

*For additional information on our Pb-Free strategy and soldering details, please download the ON Semiconductor Soldering and Mounting Techniques Reference Manual, SOLDERRM/D.

MCR703A Series

PACKAGE DIMENSIONS

DPAK-3
CASE 369D-01
ISSUE B

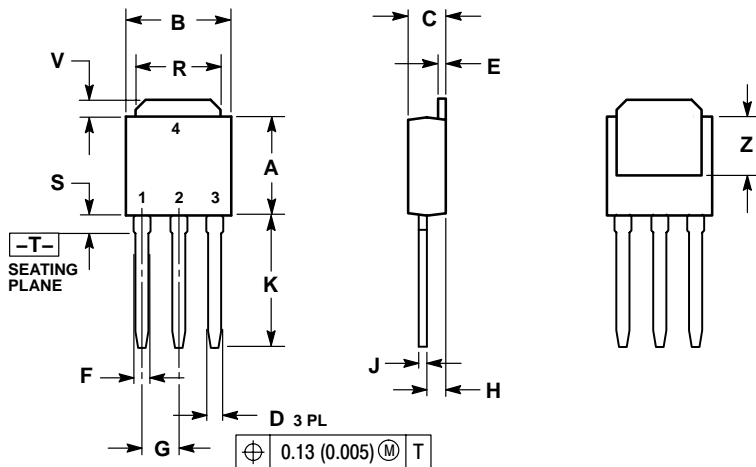

- NOTES:
1. DIMENSIONING AND TOLERANCING PER ANSI Y14.5M, 1982.
2. CONTROLLING DIMENSION: INCH.

DIM	INCHES		MILLIMETERS	
	MIN	MAX	MIN	MAX
A	0.235	0.245	5.97	6.35
B	0.250	0.265	6.35	6.73
C	0.086	0.094	2.19	2.38
D	0.027	0.035	0.69	0.88
E	0.018	0.023	0.46	0.58
F	0.037	0.045	0.94	1.14
G	0.090 BSC		2.29 BSC	
H	0.034	0.040	0.87	1.01
J	0.018	0.023	0.46	0.58
K	0.350	0.380	8.89	9.65
R	0.180	0.215	4.45	5.45
S	0.025	0.040	0.63	1.01
V	0.035	0.050	0.89	1.27
Z	0.155	---	3.93	---

- STYLE 2:
PIN 1. GATE
2. DRAIN
3. SOURCE
4. DRAIN

MCR703A Series

ON Semiconductor and  are registered trademarks of Semiconductor Components Industries, LLC (SCILLC). SCILLC reserves the right to make changes without further notice to any products herein. SCILLC makes no warranty, representation or guarantee regarding the suitability of its products for any particular purpose, nor does SCILLC assume any liability arising out of the application or use of any product or circuit, and specifically disclaims any and all liability, including without limitation special, consequential or incidental damages. "Typical" parameters which may be provided in SCILLC data sheets and/or specifications can and do vary in different applications and actual performance may vary over time. All operating parameters, including "Typicals" must be validated for each customer application by customer's technical experts. SCILLC does not convey any license under its patent rights nor the rights of others. SCILLC products are not designed, intended, or authorized for use as components in systems intended for surgical implant into the body, or other applications intended to support or sustain life, or for any other application in which the failure of the SCILLC product could create a situation where personal injury or death may occur. Should Buyer purchase or use SCILLC products for any such unintended or unauthorized application, Buyer shall indemnify and hold SCILLC and its officers, employees, subsidiaries, affiliates, and distributors harmless against all claims, costs, damages, and expenses, and reasonable attorney fees arising out of, directly or indirectly, any claim of personal injury or death associated with such unintended or unauthorized use, even if such claim alleges that SCILLC was negligent regarding the design or manufacture of the part. SCILLC is an Equal Opportunity/Affirmative Action Employer. This literature is subject to all applicable copyright laws and is not for resale in any manner.

PUBLICATION ORDERING INFORMATION

LITERATURE FULFILLMENT:

Literature Distribution Center for ON Semiconductor
P.O. Box 61312, Phoenix, Arizona 85082-1312 USA
Phone: 480-829-7710 or 800-344-3860 Toll Free USA/Canada
Fax: 480-829-7709 or 800-344-3867 Toll Free USA/Canada
Email: orderlit@onsemi.com

N. American Technical Support: 800-282-9855 Toll Free
USA/Canada

Japan: ON Semiconductor, Japan Customer Focus Center
2-9-1 Kamimeguro, Meguro-ku, Tokyo, Japan 153-0051
Phone: 81-3-5773-3850

ON Semiconductor Website: <http://onsemi.com>

Order Literature: <http://www.onsemi.com/litorder>

For additional information, please contact your
local Sales Representative.