



**SLDB101S  
THRU  
SLDB107S**

**SINGLE-PHASE GLASS PASSIVATED  
SILICON BRIDGE RECTIFIER**  
VOLTAGE RANGE 50 to 1000 Volts CURRENT 1.0 Ampere

**FEATURES**

- \* Good for automation insertion
- \* Surge overload rating - 30 amperes peak
- \* Ideal for printed circuit board
- \* Reliable low cost construction utilizing molded
- \* Glass passivated device
- \* Polarity symbols molded on body
- \* Mounting position: Any
- \* Weight: 0.33 gram

**MECHANICAL DATA**

- \* Epoxy: Device has UL flammability classification 94V-O

**MAXIMUM RATINGS AND ELECTRICAL CHARACTERISTICS**

Ratings at 25 °C ambient temperature unless otherwise specified.  
resistive or inductive load.

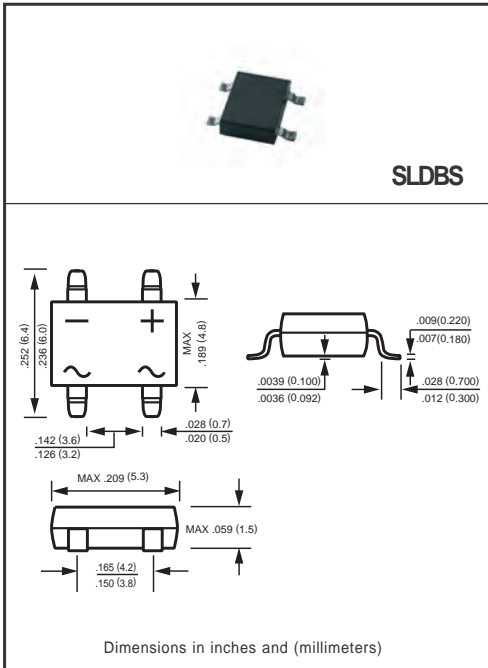

MAXIMUM RATINGS (At T<sub>A</sub> = 25°C unless otherwise noted)

RATINGS	SYMBOL	SLDB101S	SLDB102S	SLDB103S	SLDB104S	SLDB105S	SLDB106S	SLDB107S	UNITS
Maximum Recurrent Peak Reverse Voltage	V <sub>RRM</sub>	50	100	200	400	600	800	1000	Volts
Maximum RMS Bridge Input Voltage	V <sub>RMS</sub>	35	70	140	280	420	560	700	Volts
Maximum DC Blocking Voltage	V <sub>DC</sub>	50	100	200	400	600	800	1000	Volts
Maximum Average Forward Output Current at T <sub>A</sub> = 40°C	I <sub>O</sub>	1.0							Amps
Peak Forward Surge Current 8.3 ms single half sine-wave superimposed on rated load (JEDEC method)	I <sub>FSM</sub>	30							Amps
Typical Current Squared Time	i <sup>2</sup> t	3.7							A <sup>2</sup> S
Typical Thermal Resistance (Note 2)	R <sub>θJA</sub>	62.5							°C/W
	R <sub>θJL</sub>	25							
Operating and Storage Temperature Range	T <sub>J</sub> ,T <sub>STG</sub>	-55 to + 150							°C

ELECTRICAL CHARACTERISTICS (At T<sub>A</sub> = 25°C unless otherwise noted)

CHARACTERISTICS	SYMBOL	SLDB101S	SLDB102S	SLDB103S	SLDB104S	SLDB105S	SLDB106S	SLDB107S	UNITS
Maximum Forward Voltage Drop per Bridge Element at 1.0A DC	V <sub>F</sub>	1.1							Volts
Maximum Reverse Current at Rated	I <sub>R</sub>	5.0							uAmps
DC Blocking Voltage per element		0.5							mAmps

Note: 1. "Fully ROHS compliant", "100% Sn plating(Pb-free).  
2. Thermal Resistance: Mounted on PCB.  
3. Available in Halogen-free epoxy by adding suffix -HF after the part nbr.

## RATING AND CHARACTERISTICS CURVES ( SLDB101S THRU SLDB107S )

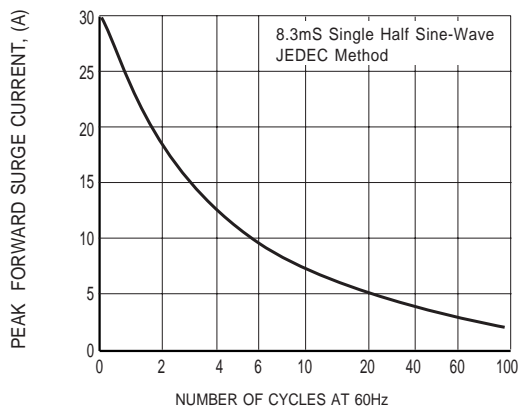

FIG. 1 - MAXIMUM NON-REPETITIVE FORWARD SURGE CURRENT

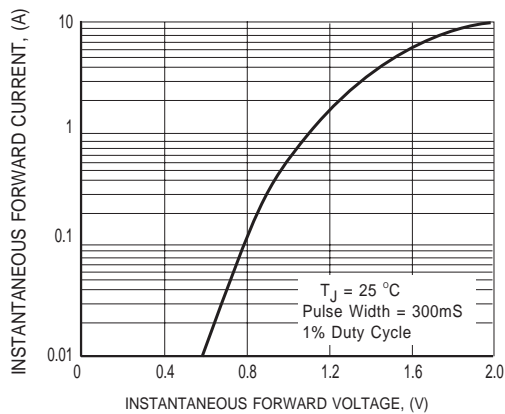

FIG.2 TYPICAL INSTANTANEOUS FORWARD CHARACTERISTICS

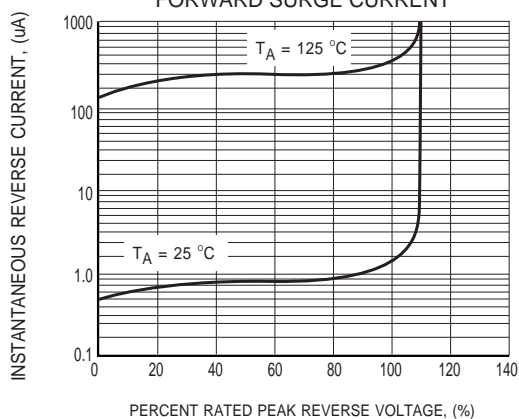

FIG.3 TYPICAL REVERSE CHARACTERISTICS

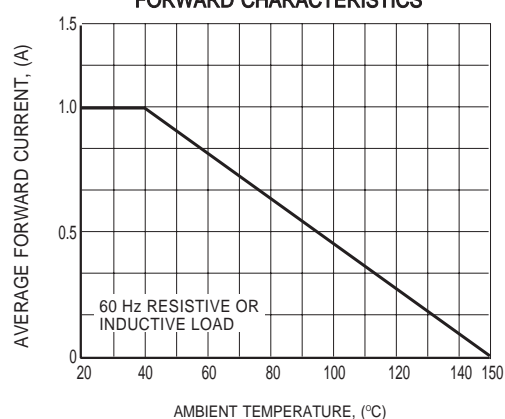
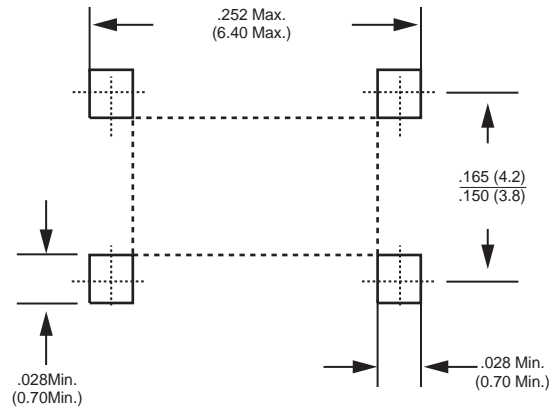

FIG.4 TYPICAL FORWARD CURRENT DERATING CURVE

## Mounting Pad Layout



Dimensions in inches and (millimeters)

## Marking Description

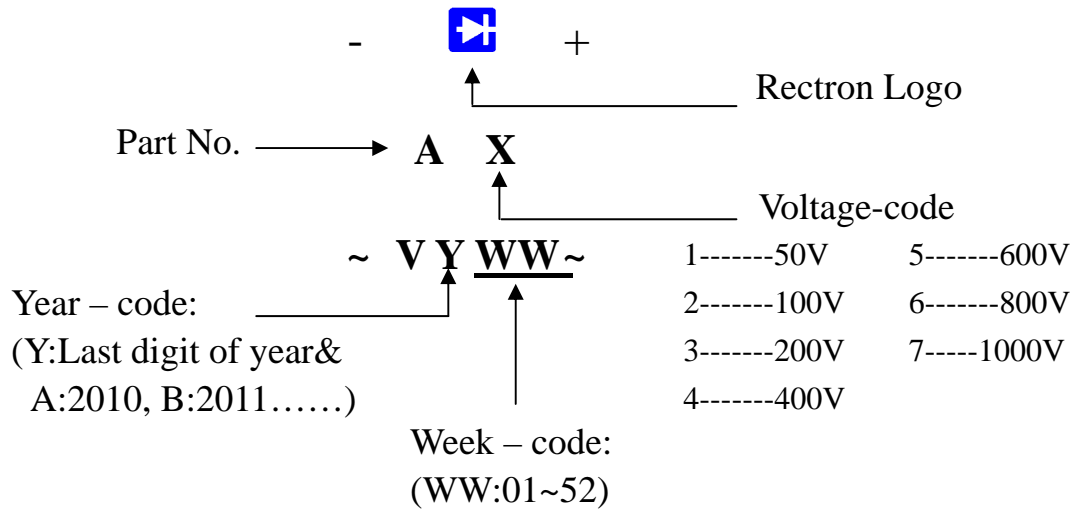

## DISCLAIMER NOTICE

Rectron Inc reserves the right to make changes without notice to any product specification herein, to make corrections, modifications, enhancements or other changes. Rectron Inc or anyone on its behalf assumes no responsibility or liability for any errors or inaccuracies. Data sheet specifications and its information contained are intended to provide a product description only. "Typical" parameters which may be included on RECTRON data sheets and/ or specifications can and do vary in different applications and actual performance may vary over time. Rectron Inc does not assume any liability arising out of the application or use of any product or circuit.

Rectron products are not designed, intended or authorized for use in medical, life-saving implant or other applications intended for life-sustaining or other related applications where a failure or malfunction of component or circuitry may directly or indirectly cause injury or threaten a life without expressed written approval of Rectron Inc. Customers using or selling Rectron components for use in such applications do so at their own risk and shall agree to fully indemnify Rectron Inc and its subsidiaries harmless against all claims, damages and expenditures.