**SOT23-6W 120mA 2ch LDO
REGULATORS
R5322N SERIES**

APPLICATION MANUAL

R5322N SERIES

OUTLINE

The R5322N Series are voltage regulator ICs with high output voltage accuracy, low supply current, low dropout, and high ripple rejection by CMOS process. Each of these voltage regulator ICs consists of a voltage reference unit, an error amplifier, resistors for setting Output Voltage, a current limit circuit, and a chip enable circuit.

These ICs perform with low dropout voltage due to built-in transistor with low ON resistance, and a chip enable function and prolong the battery life of each system. The line transient response and load transient response of the R5322N Series are excellent, thus these ICs are very suitable for the power supply for hand-held communication equipment.

The output voltage of these ICs is internally fixed with high accuracy. Since the package for these ICs is SOT-23-6W package, and include 2ch LDO regulators each, high density mounting of the ICs on boards is possible.

FEATURES

- Ultra-Low Supply Current TYP. 75 μ A (VR1,VR2)
- Standby Mode TYP. 0.1 μ A (VR1,VR2)
- Low Dropout Voltage TYP. 0.15V ($I_{OUT}=100$ mA Output Voltage=3.0V Type)
- High Ripple Rejection TYP. 75dB (f=1kHz)
- Low Temperature-Drift Coefficient of Output Voltage..... TYP. ± 100 ppm/ $^{\circ}$ C
- Excellent Line Regulation..... TYP. 0.05%/V
- High Output Voltage Accuracy $\pm 2.0\%$
- Small Package SOT-23-6W
- Output Voltage..... Stepwise setting with a step of 0.1V in the range of 1.5V to 4.0V is possible
- Built-in chip enable circuit (A/B: active high)
- Built-in fold-back protection circuit..... TYP. 40mA (Current at short mode)

APPLICATIONS

- Power source for cellular phones such as GSM, CDMA and various kinds of PCS.
- Power source for electrical appliances such as cameras, VCRs and camcorders.
- Power source for battery-powered equipment.

BLOCK DIAGRAM

• R5322NxxxA

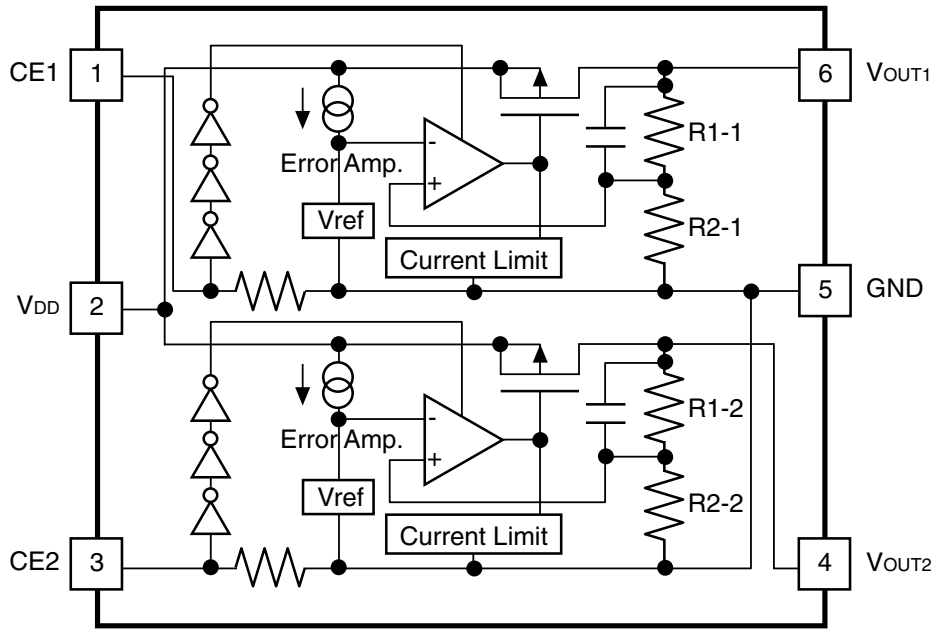

• R5322NxxxB

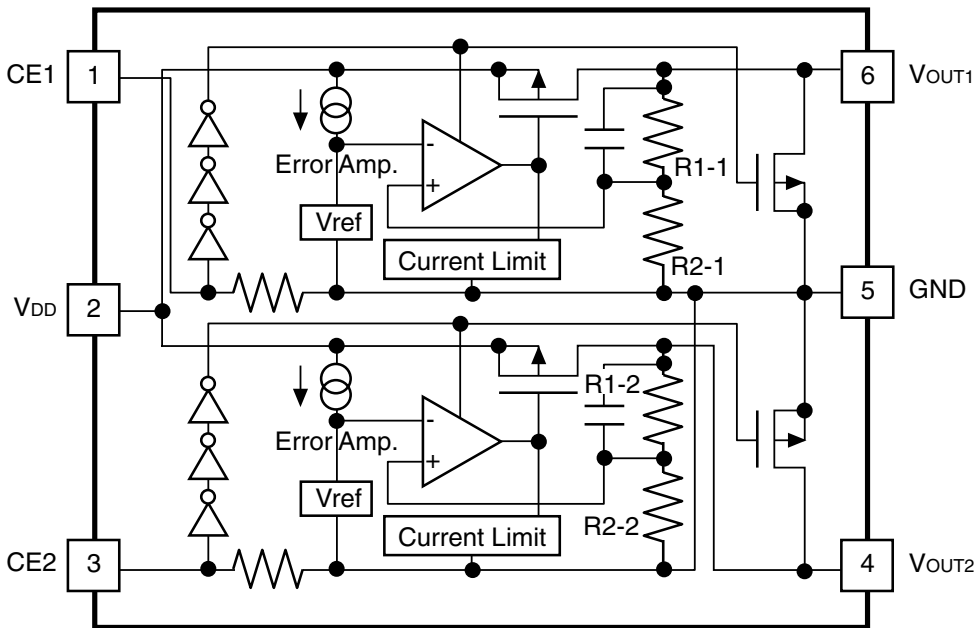

SELECTION GUIDE

The output voltage, mask option, and the taping type for the ICs can be selected at the user's request. The selection can be made with designating the part number as shown below;

R5322Nxxxx-xx ←Part Number
 ↑ ↑ ↑
 a b c

Code	Contents
a	Setting combination of 2ch Output Voltage (V_{OUT}) : Serial Number for Voltage Setting, Stepwise setting with a step of 0.1V in the range of 1.5V to 4.0V is possible for each channel.
b	Designation of Mask Option : A version: without auto discharge function at OFF state. B version: with auto discharge function at OFF state.
c	Designation of Taping Type : Ex. TR (refer to Taping Specifications; TR type is the standard direction.)

PIN CONFIGURATION

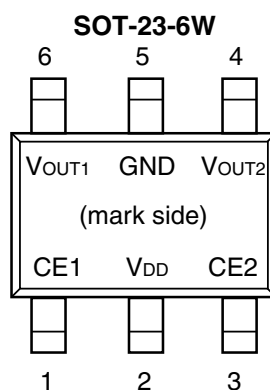

PIN DESCRIPTION

Pin No.	Symbol	Description
1	CE1	Chip Enable Pin 1
2	V_{DD}	Input Pin
3	CE2	Chip Enable Pin 2
4	V_{OUT2}	Output Pin 2
5	GND	Ground Pin
6	V_{OUT1}	Output Pin 1

ABSOLUTE MAXIMUM RATINGS

Symbol	Item	Rating	Unit
V_{IN}	Input Voltage	6.5	V
V_{CE}	Input Voltage (CE Pin)	$-0.3 \sim V_{IN}+0.3$	V
V_{OUT}	Output Voltage	$-0.3 \sim V_{IN}+0.3$	V
I_{OUT1}	Output Current 1	130	mA
I_{OUT2}	Output Current 2	130	mA
P_D	Power Dissipation	250	mW
T_{opt}	Operating Temperature Range	$-40 \sim 85$	°C
T_{stg}	Storage Temperature Range	$-55 \sim 125$	°C

ELECTRICAL CHARACTERISTICS

• R5322NxxxA/B

T_{opt}=25°C

Symbol	Item	Conditions	MIN.	TYP.	MAX.	Unit
V _{OUT}	Output Voltage	V _{IN} = Set V _{OUT} +1V 1mA ≤ I _{OUT} ≤ 30mA	V _{OUT} ×0.98		V _{OUT} ×1.02	V
I _{OUT}	Output Current	V _{IN} - V _{OUT} = 1.0V	120			mA
ΔV _{OUT} /ΔI _{OUT}	Load Regulation	V _{IN} = Set V _{OUT} +1V 1mA ≤ I _{OUT} ≤ 120mA		12	40	mV
V _{DIF}	Dropout Voltage	Refer to the ELECTRICAL CHARACTERISTICS by OUTPUT VOLT-AGE				
I _{SS}	Supply Current	V _{IN} = Set V _{OUT} +1V		75	150	μA
Istandby	Supply Current (Standby)	V _{IN} = V _{CE} = Set V _{OUT} +1V		0.1	1.0	μA
ΔV _{OUT} /ΔV _{IN}	Line Regulation	Set V _{OUT} +0.5V ≤ V _{IN} ≤ 6V I _{OUT} = 30mA (In case that V _{OUT} ≤ 1.6V, 2.2V ≤ V _{IN} ≤ 6V)		0.05	0.20	%/V
RR	Ripple Rejection	f = 1kHz, Ripple 0.5Vp-p V _{IN} = Set V _{OUT} +1V, I _{OUT} = 30mA		75		dB
V _{IN}	Input Voltage		2.2		6.0	V
ΔV _{OUT} /ΔT	Output Voltage Temperature Coefficient	I _{OUT} = 30mA -40°C ≤ T _{opt} ≤ 85°C		±100		ppm /°C
I _{lim}	Short Current Limit	V _{OUT} = 0V		40		mA
R _{PD}	CE Pull-down Resistance		1.5	4	16	MΩ
V _{CEH}	CE Input Voltage "H"		1.5		V _{IN}	V
V _{CEL}	CE Input Voltage "L"		0.0		0.3	V
en	Output Noise	BW=10Hz to 100kHz		30		μV _{rms}
R _{LOW}	Low Output Nch Tr. ON Resistance (of B version)	V _{CE} =0V		70		Ω

• ELECTRICAL CHARACTERISTICS by OUTPUT VOLTAGE

Topt = 25°C

Output Voltage V_{OUT} (V)	Dropout Voltage		
	V_{DIF} (V)		
	Condition	TYP.	MAX.
$1.5 \leq V_{OUT} \leq 1.6$	$I_{OUT} = 120mA$	0.36	0.70
$1.7 \leq V_{OUT} \leq 1.8$		0.30	0.50
$1.9 \leq V_{OUT} \leq 2.0$		0.28	0.45
$2.1 \leq V_{OUT} \leq 2.7$		0.24	0.40
$2.8 \leq V_{OUT} \leq 4.0$		0.18	0.30

TEST CIRCUITS

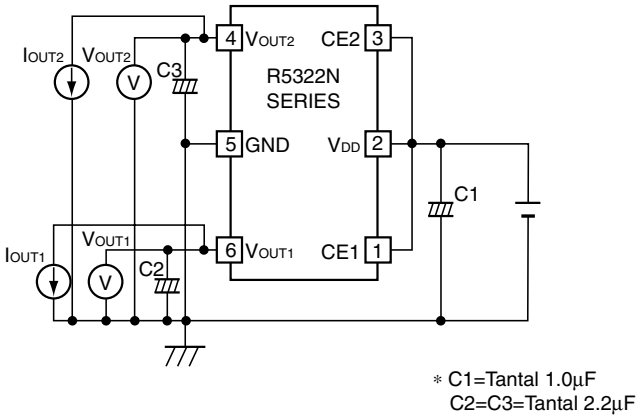

Fig.1 Standard test Circuit

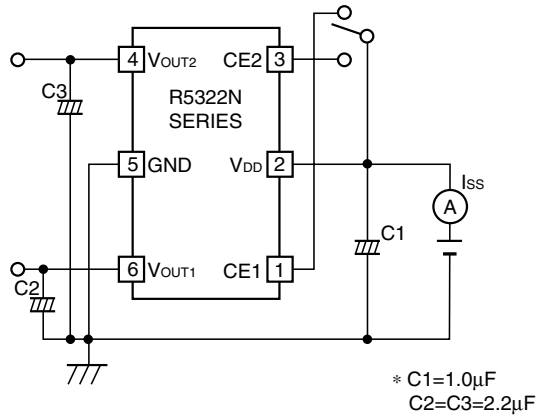

Fig.2 Supply Current Test Circuit

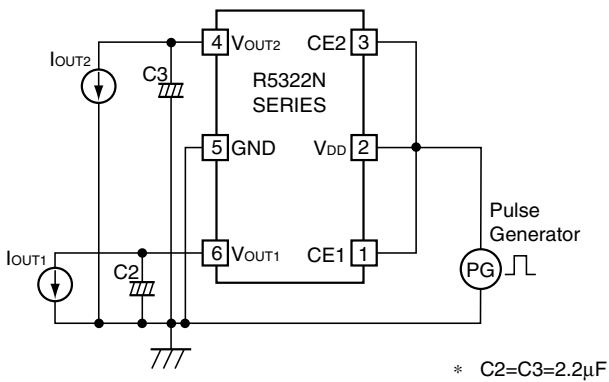

Fig.3 Ripple Rejection, Line Transient Response Test Circuit

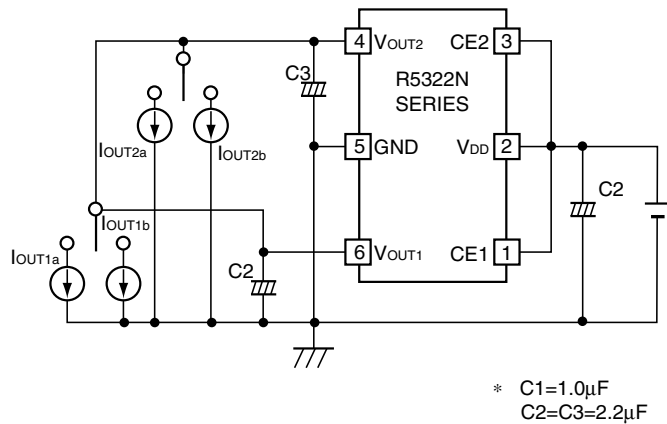
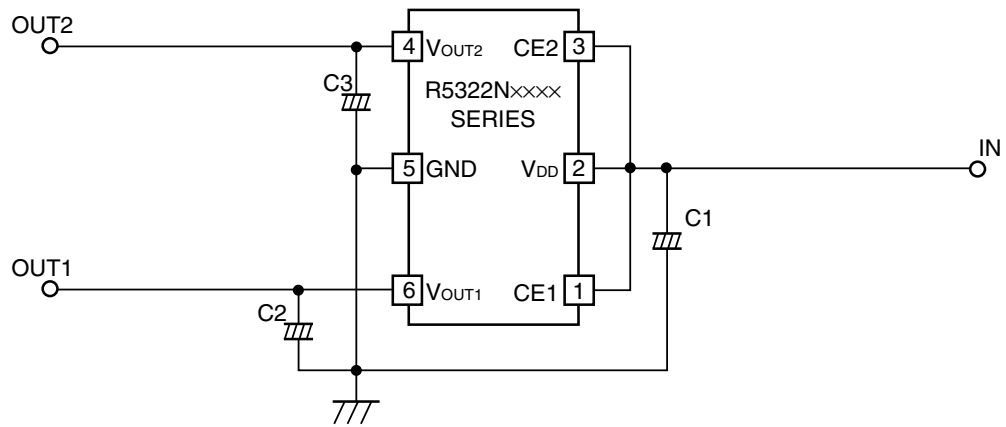

Fig.4 Load Transient Response Test Circuit

TYPICAL APPLICATION

(External Components) Output Capacitor; Tantalum Type

TYPICAL CHARACTERISTICS

1) Output Voltage vs. Output Current

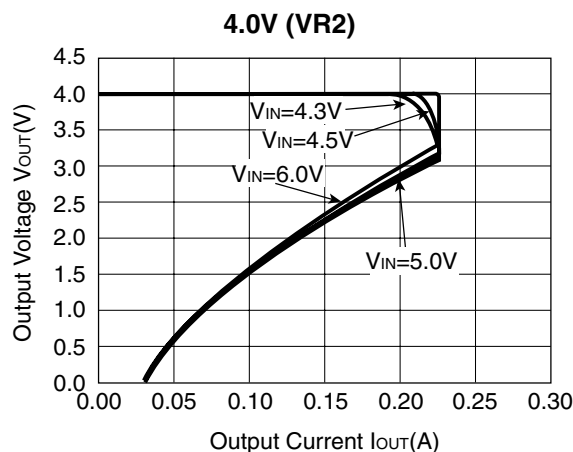
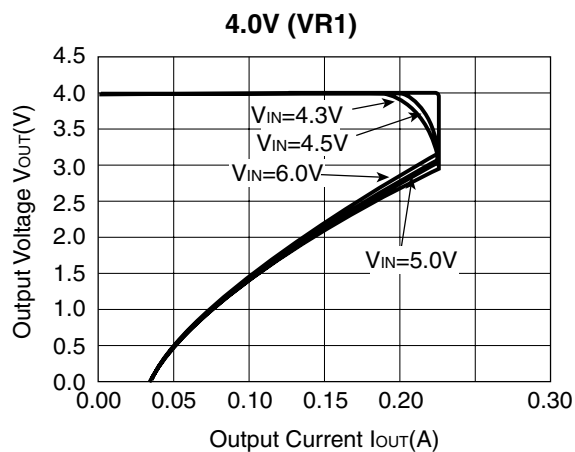
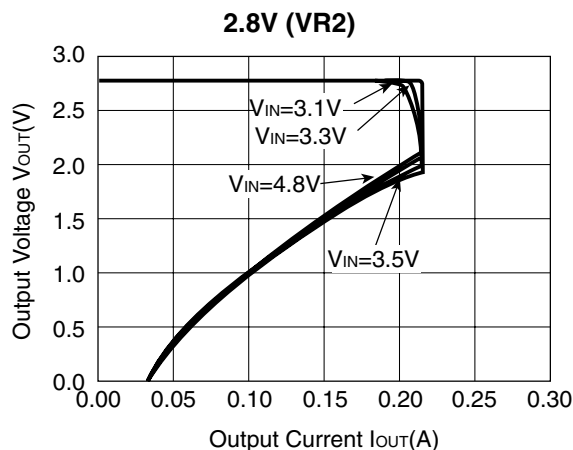
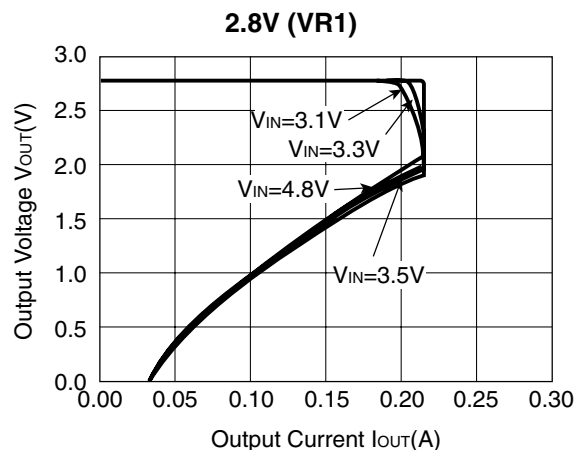
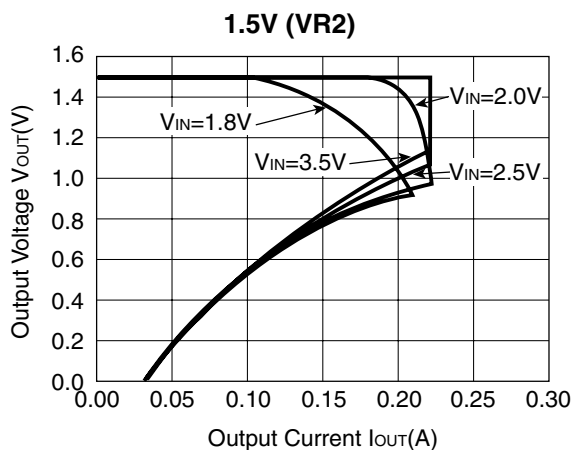
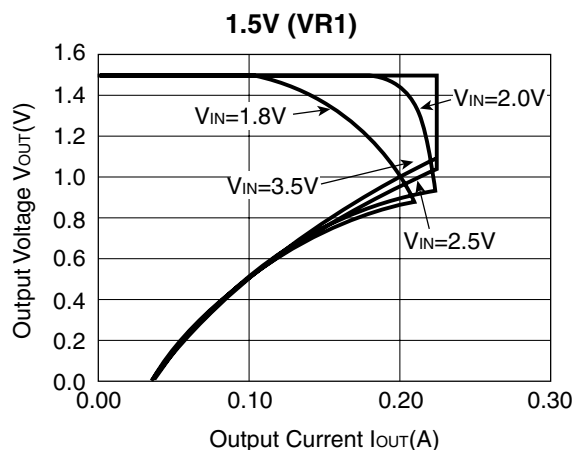

2) Output Voltage vs. Input Voltage

1.5V (VR1)

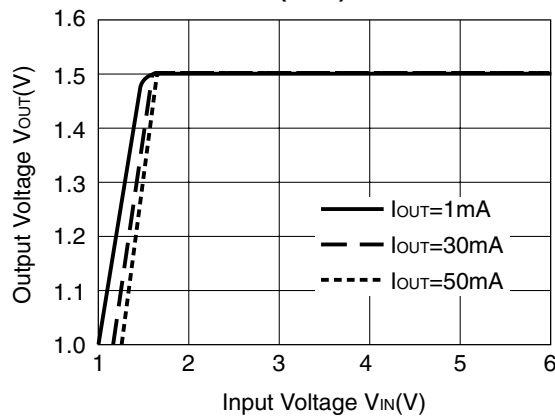

1.5V (VR2)

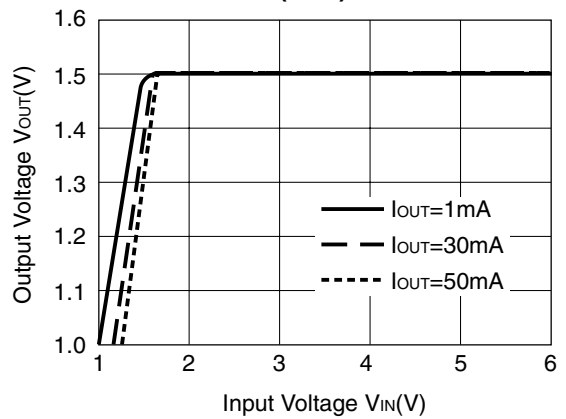

2.8V (VR1)

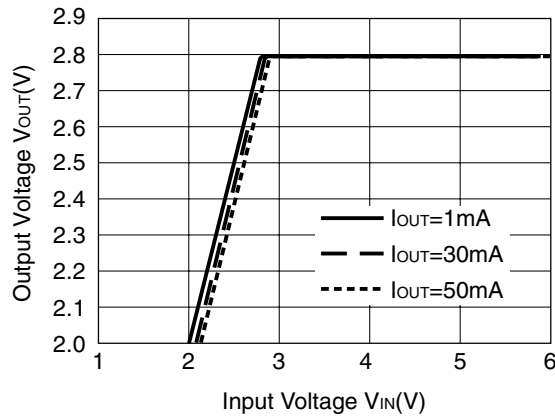

2.8V (VR2)

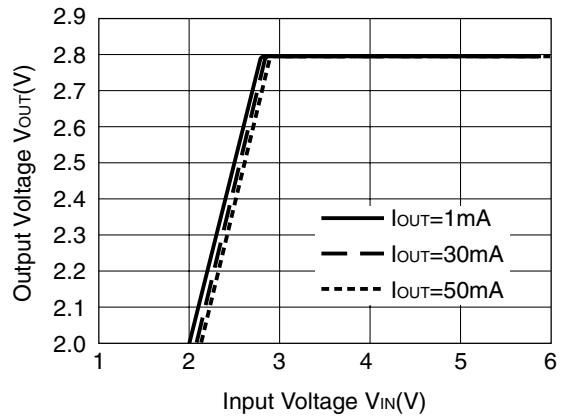

4.0V (VR1)

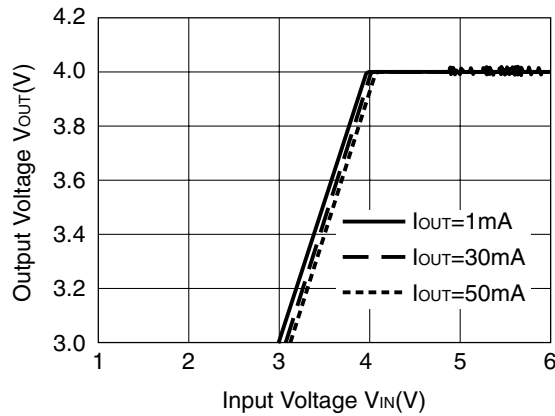

4.0V (VR2)

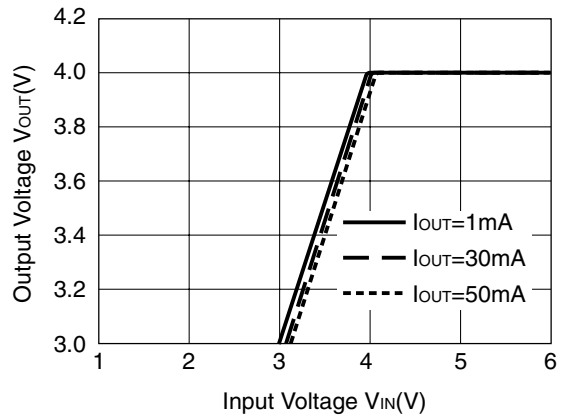

3) Dropout Voltage vs. Temperature

1.5V (VR1)

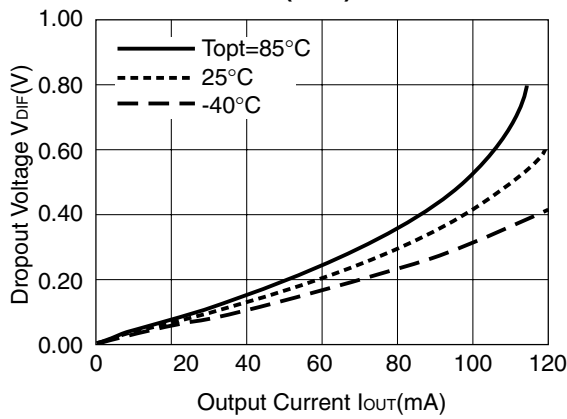

1.5V (VR2)

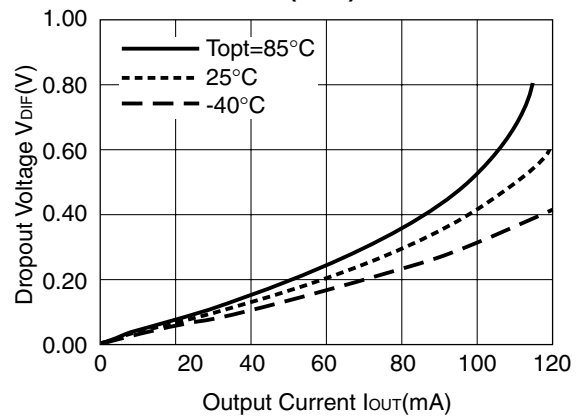

2.8V (VR1)

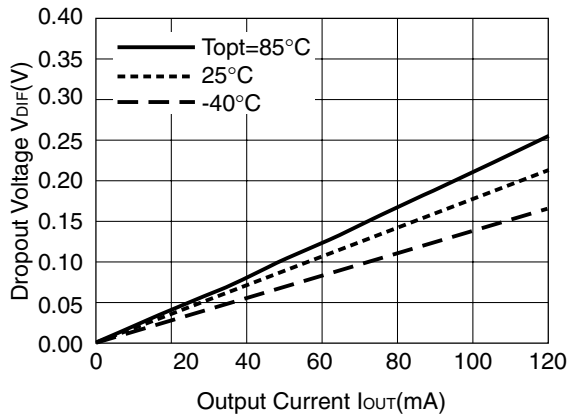

2.8V (VR2)

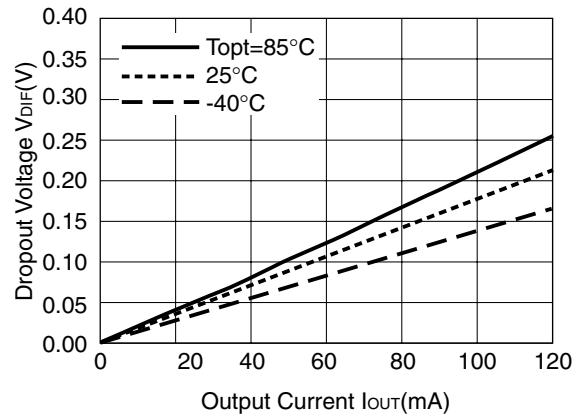

4.0V (VR1)

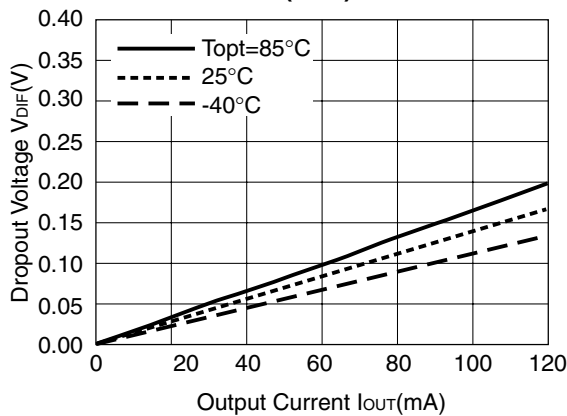

4.0V (VR2)

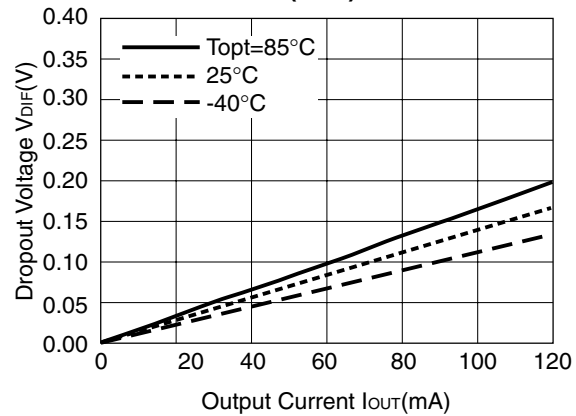

4) Output Voltage vs. Temperature

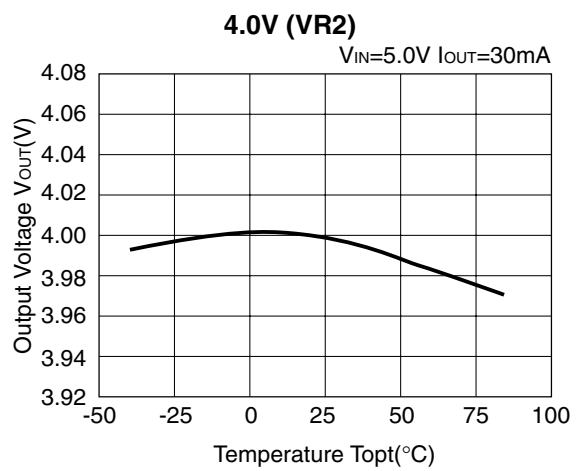
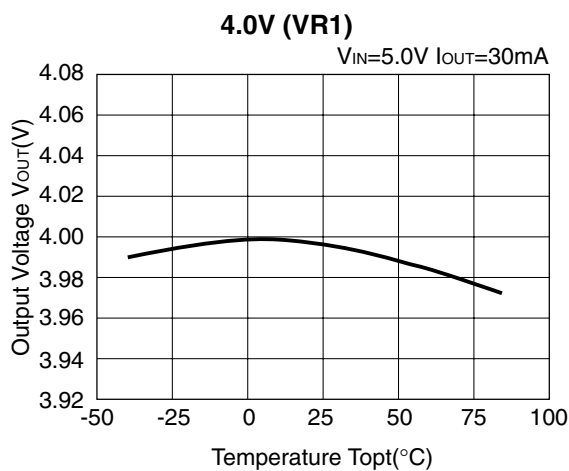
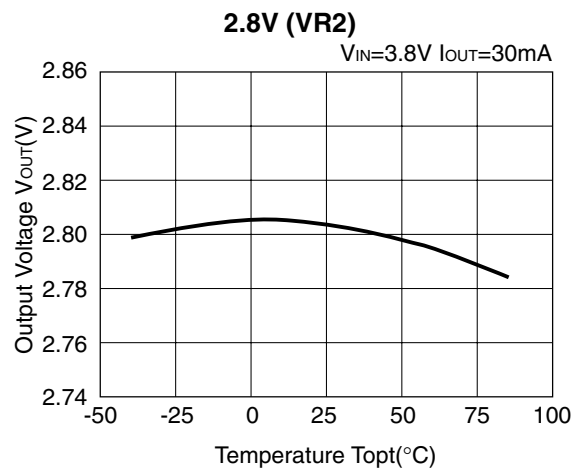
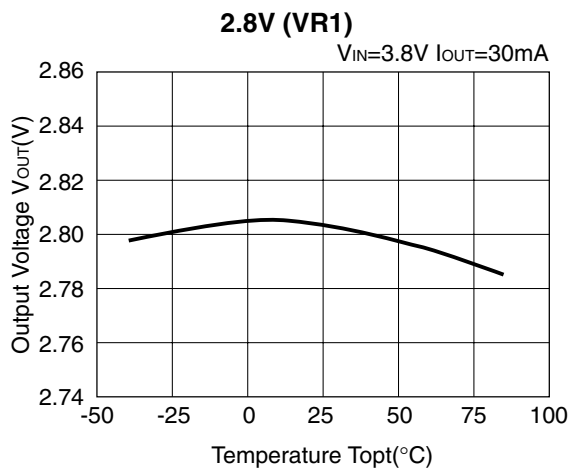
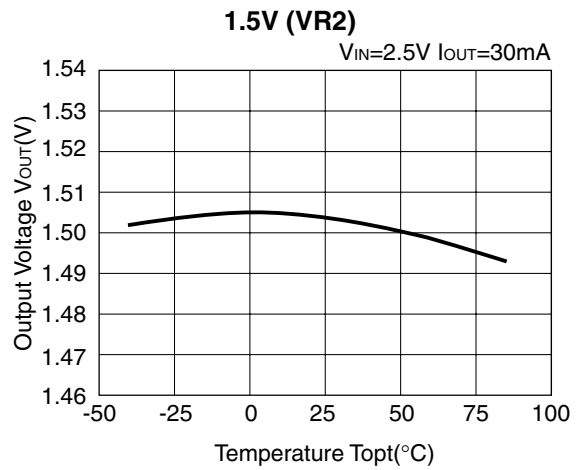
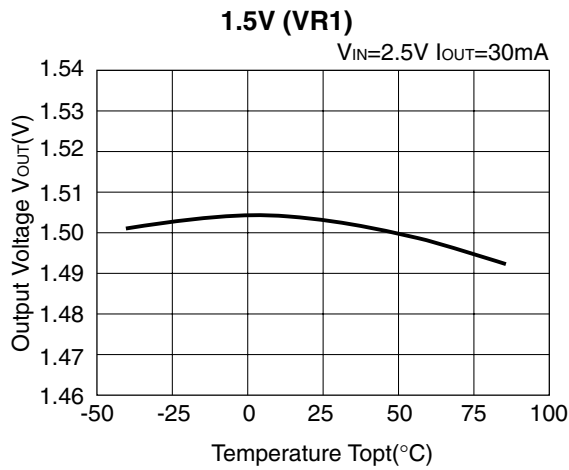

5) Supply Current vs. Input Voltage

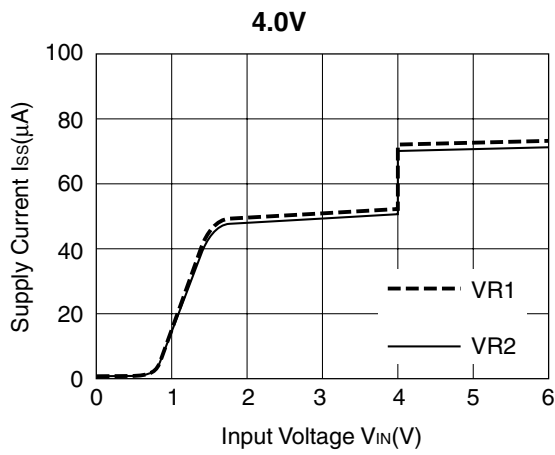
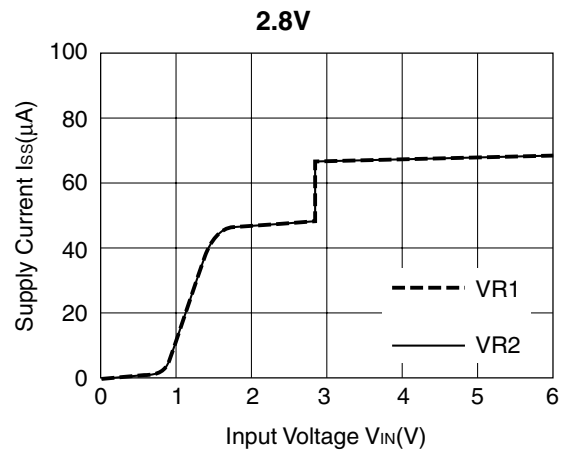
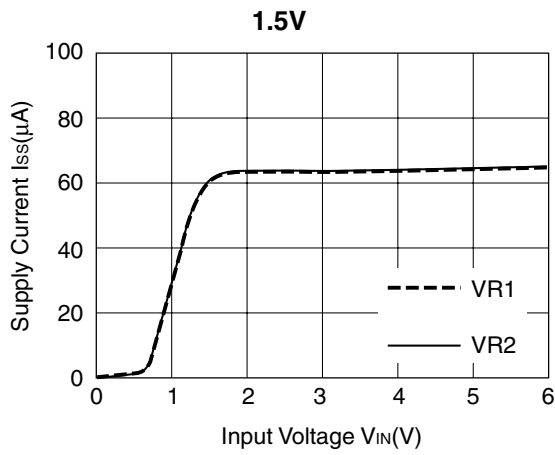

6) Supply Current vs. Temperature

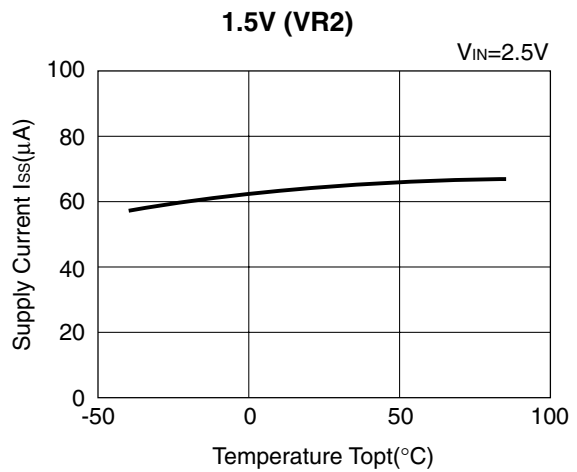
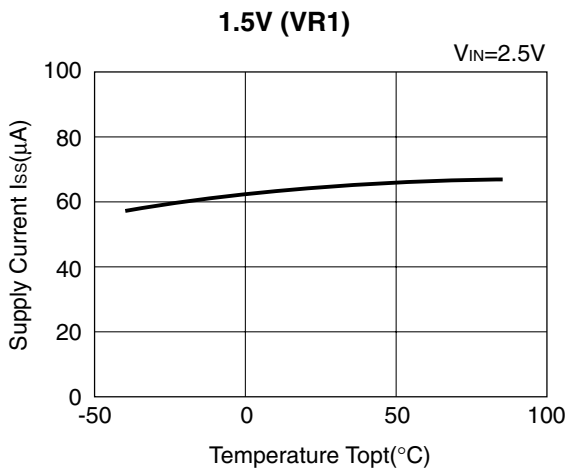

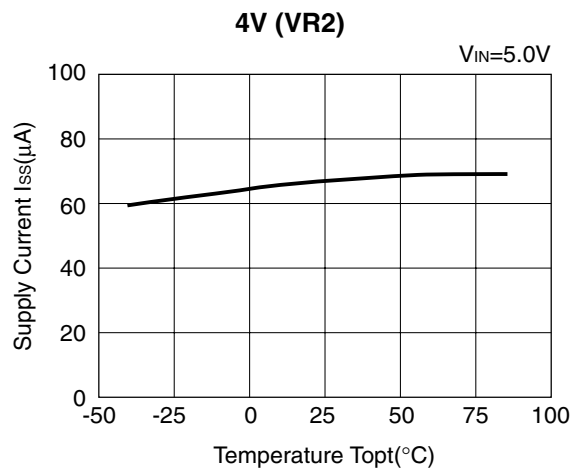
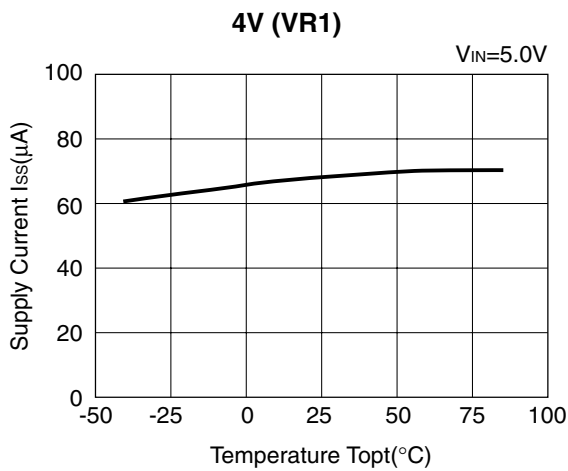
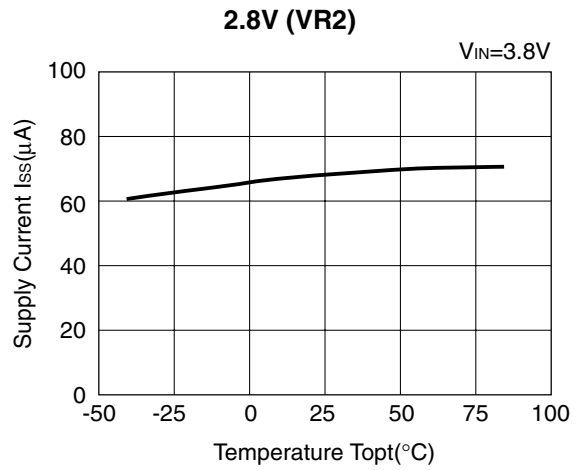
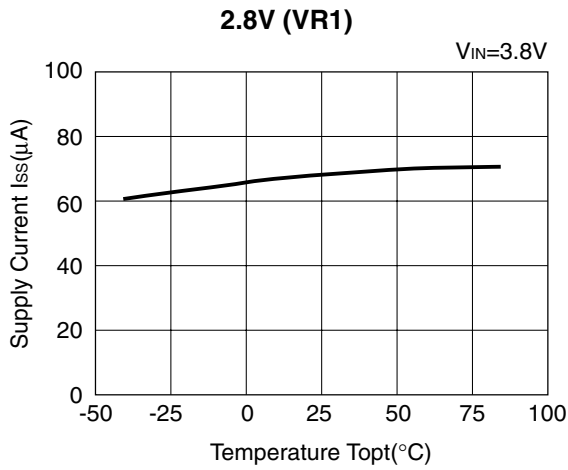

7) Dropout Voltage vs. Set Output Voltage

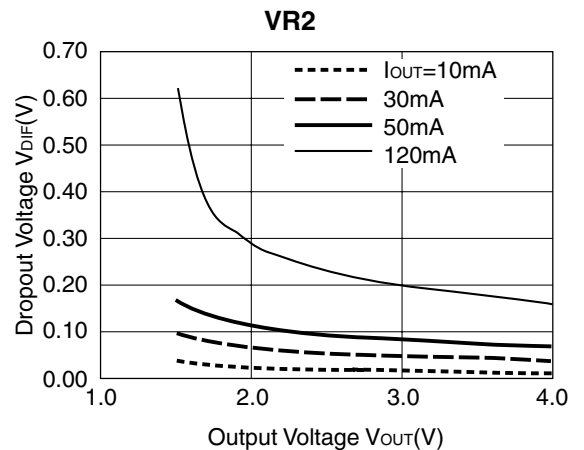
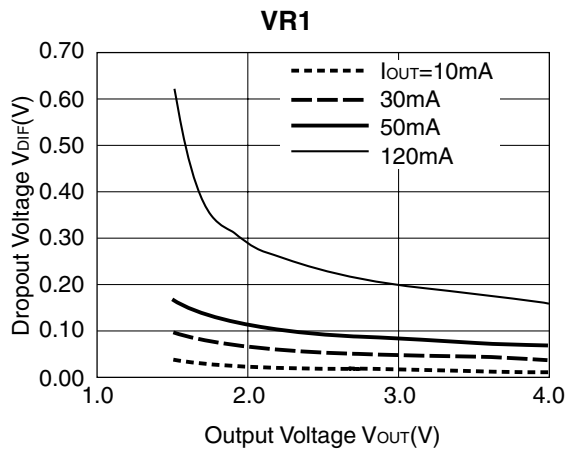

8) Ripple Rejection vs. Frequency

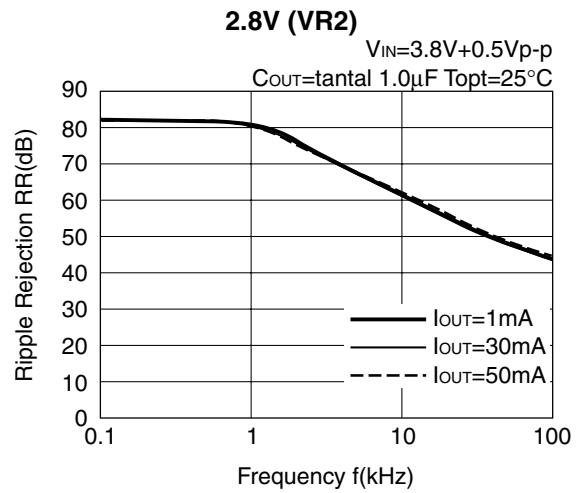
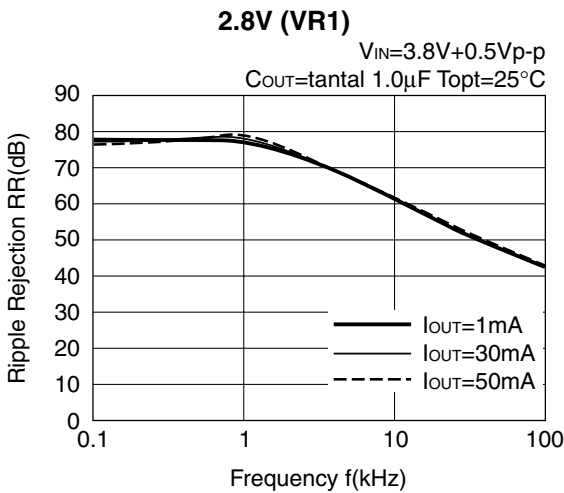
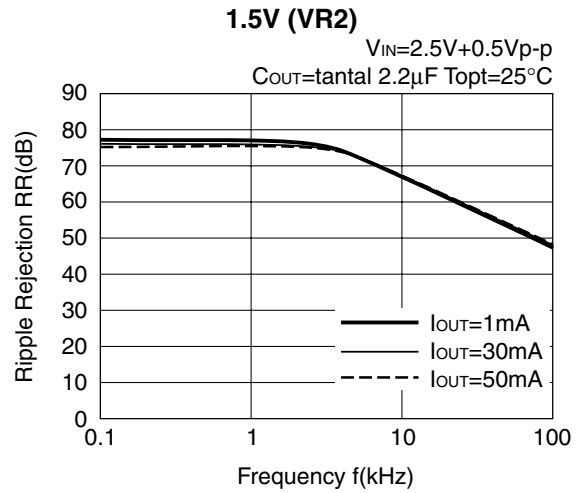
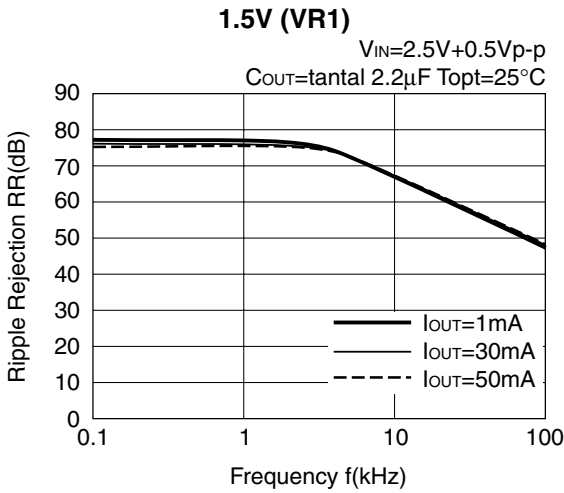
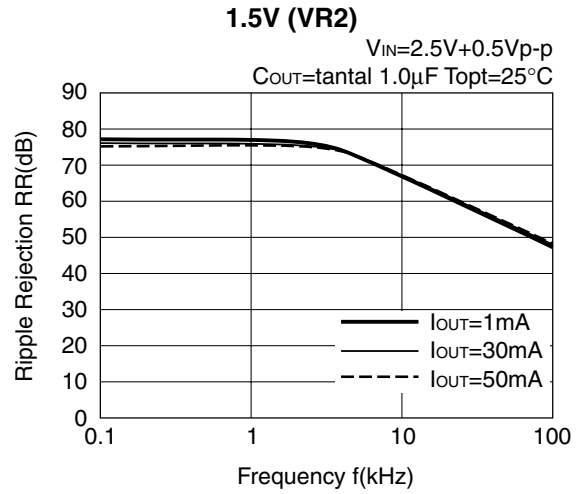
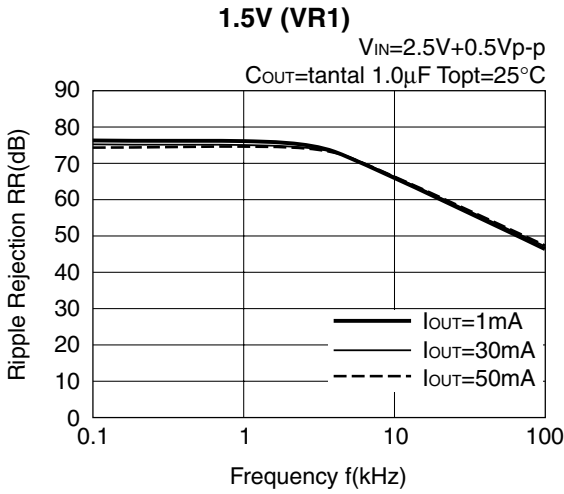

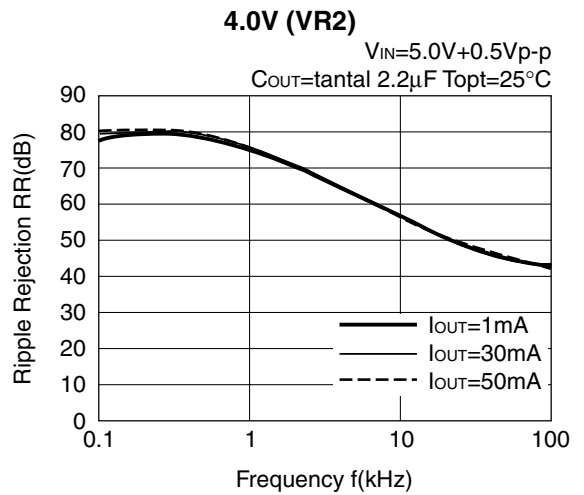
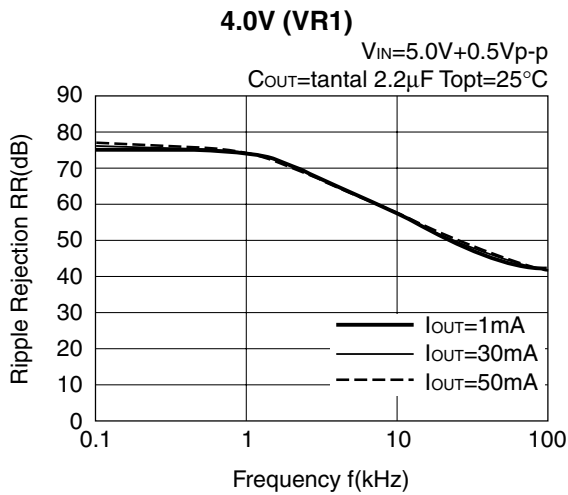
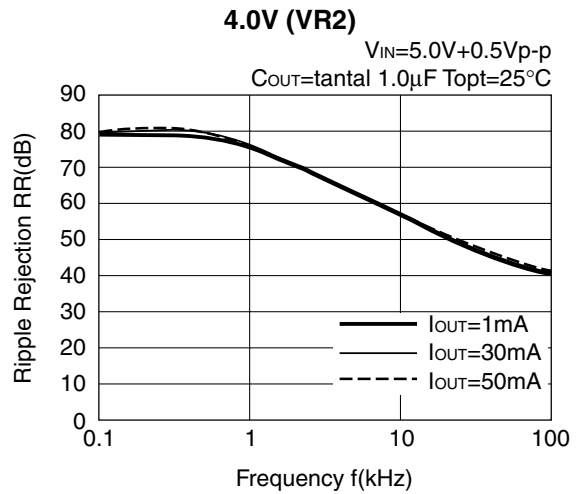
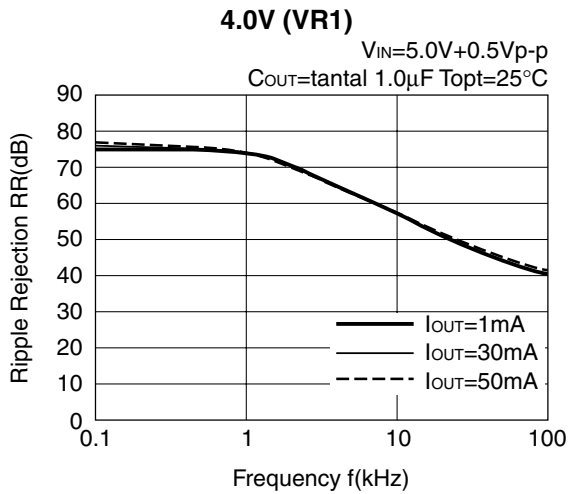
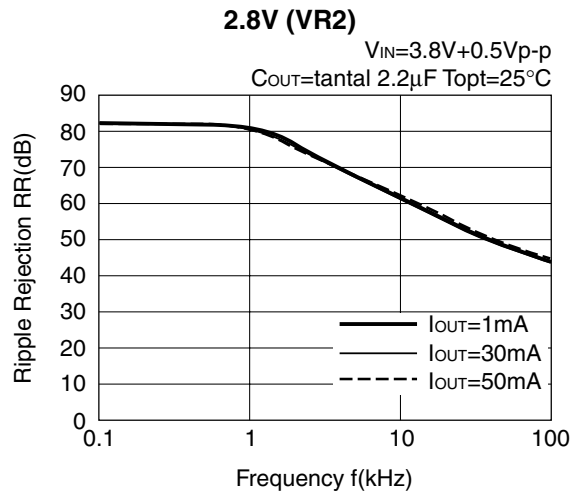
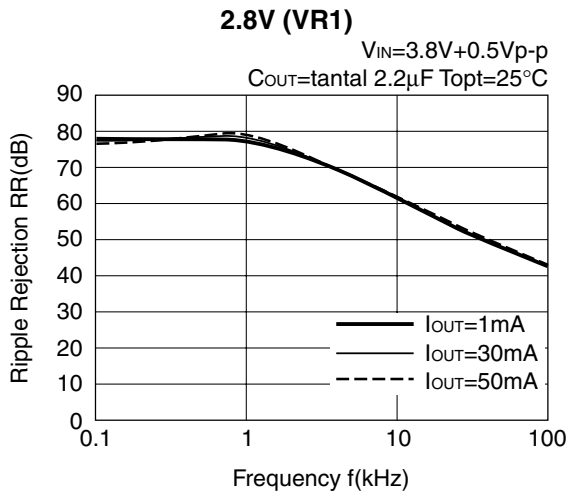

9) Ripple Rejection vs. Input Voltage (DC bias)

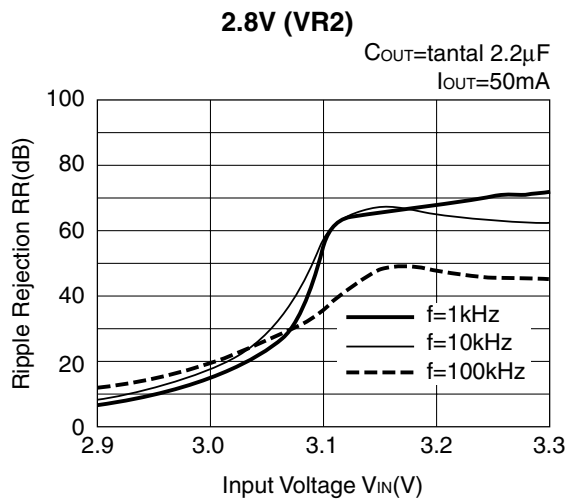
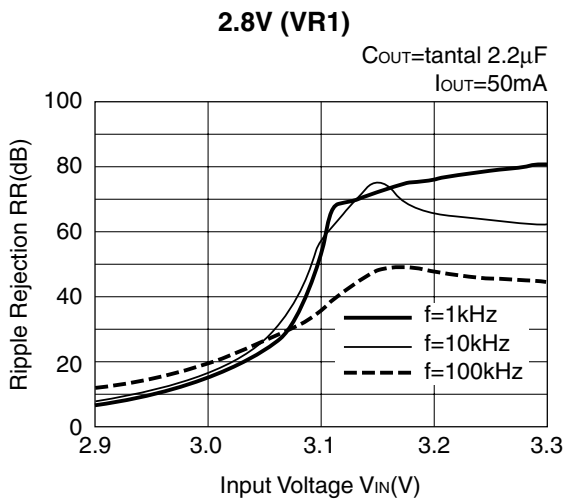
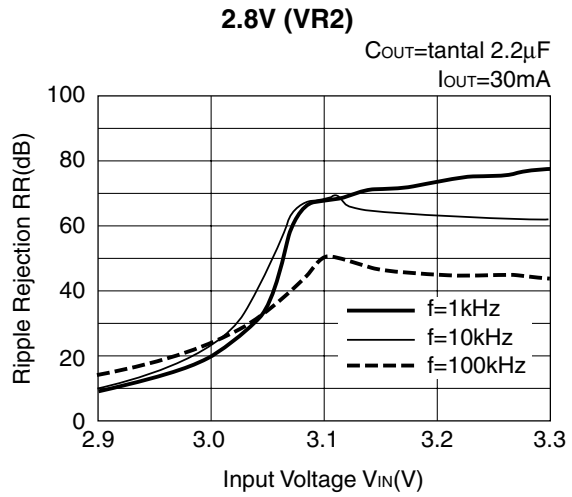
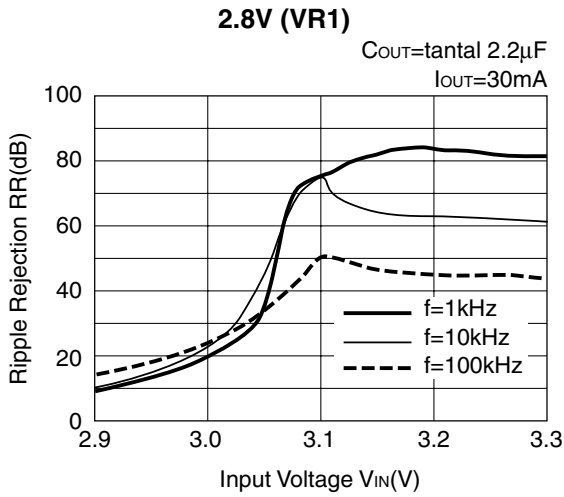
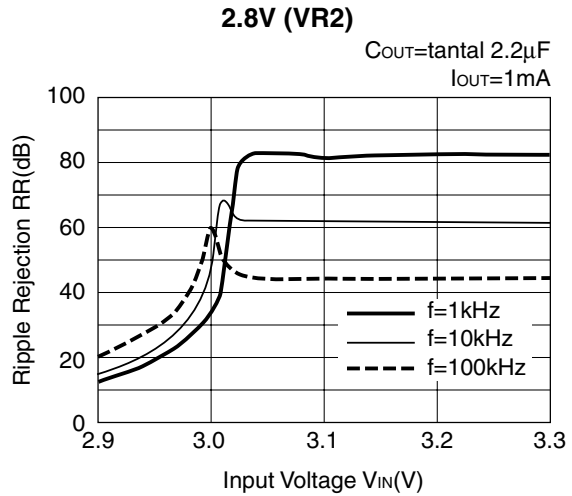
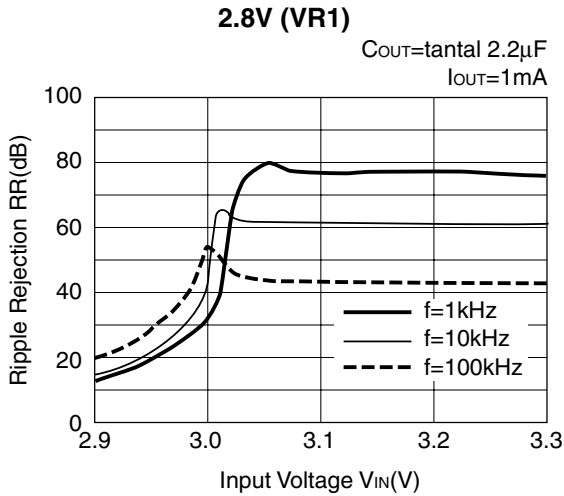

10) Input Transient Response

R5322N001x (2.8V, VR1)

$I_{OUT}=30mA$ $C_{OUT}=\text{tantal } 1.0\mu F$
 $tr/tf=5\mu s$ $T_{opt}=25^{\circ}C$

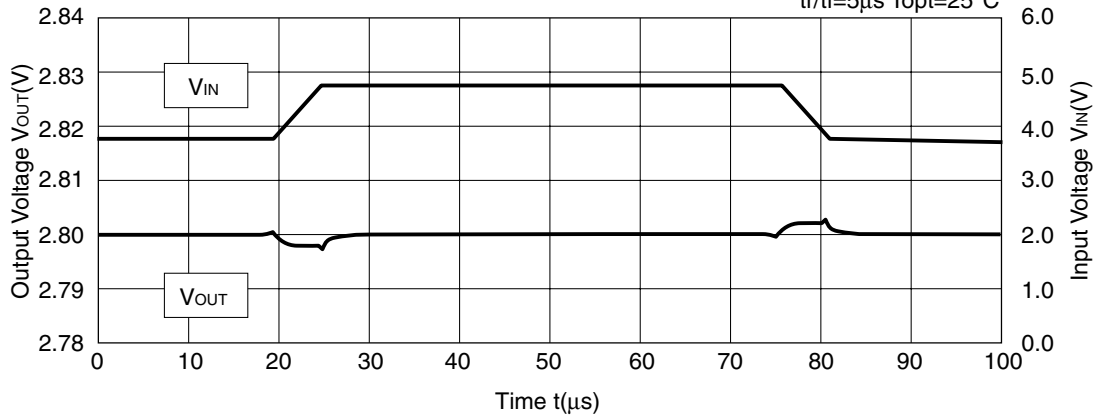

R5322N001x (2.8V, VR1)

$I_{OUT}=30mA$ $C_{OUT}=\text{tantal } 2.2\mu F$
 $tr/tf=5\mu s$ $T_{opt}=25^{\circ}C$

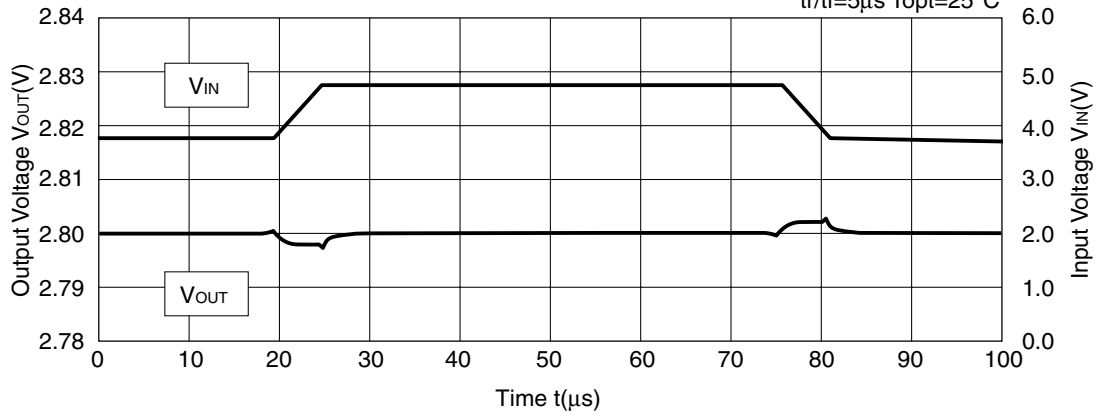

R5322N001x (2.8V, VR1)

$I_{OUT}=30mA$ $C_{OUT}=\text{tantal } 6.8\mu F$
 $tr/tf=5\mu s$ $T_{opt}=25^{\circ}C$

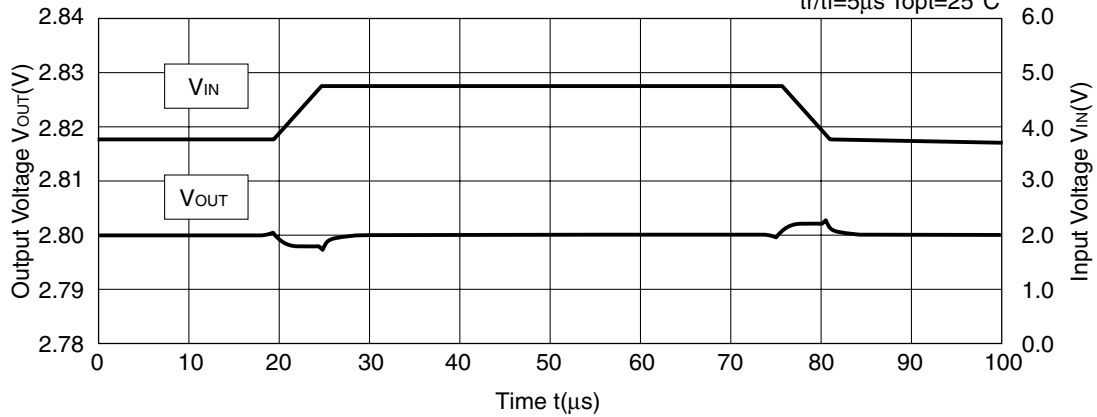

R5322N001x (2.8V, VR2)

$I_{OUT}=30mA$ $C_{OUT}=\text{tantal } 1.0\mu F$
 $tr/tf=5\mu s$ $T_{opt}=25^{\circ}C$

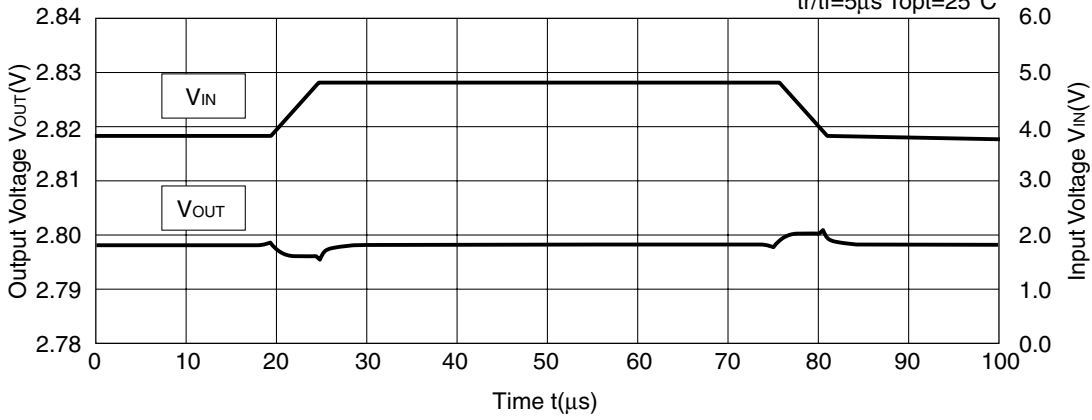

R5322N001x (2.8V, VR2)

$I_{OUT}=30mA$ $C_{OUT}=\text{tantal } 2.2\mu F$
 $tr/tf=5\mu s$ $T_{opt}=25^{\circ}C$

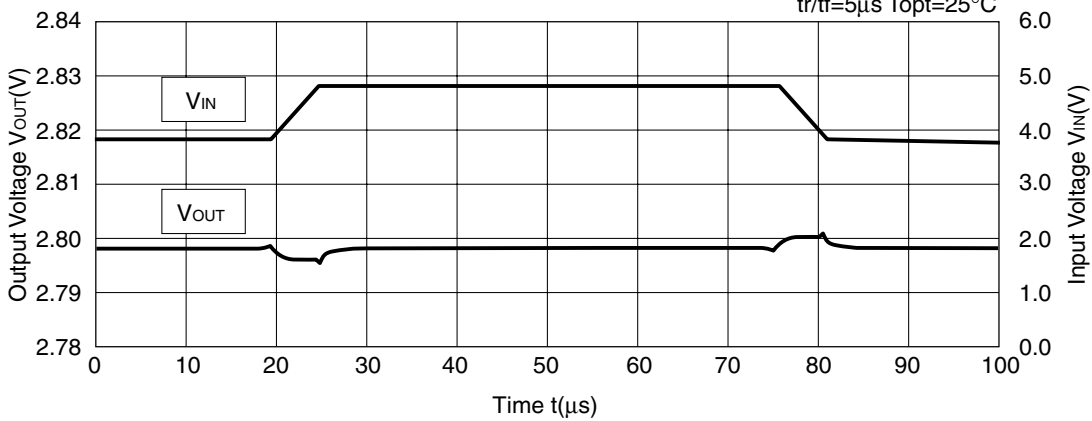

R5322N001x (2.8V, VR2)

$I_{OUT}=30mA$ $C_{OUT}=\text{tantal } 6.8\mu F$
 $tr/tf=5\mu s$ $T_{opt}=25^{\circ}C$

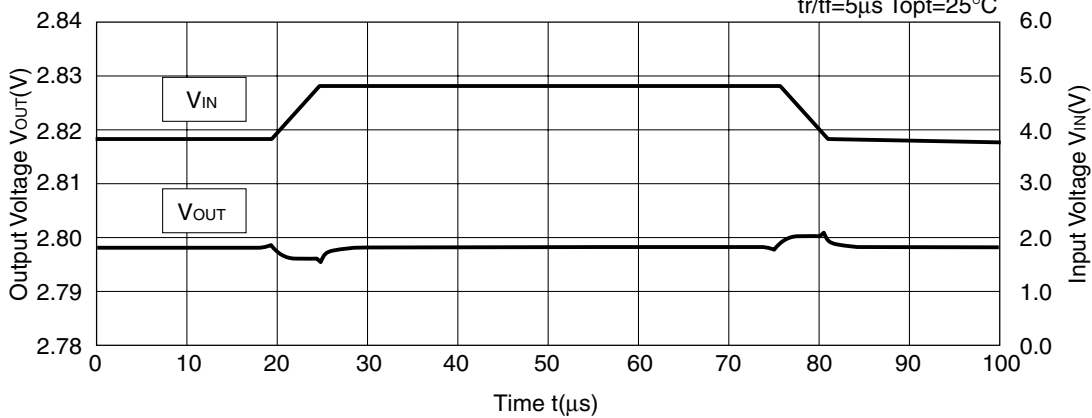

11) Load Transient Response

R5322N001x (VR1=2.8V)

$I_{OUT}=50\text{mA} \leftrightarrow 100\text{mA}$ $V_{IN}=3.8\text{V}$ $C_{IN}=\text{tantal } 1.0\mu\text{F}$
 $C_{OUT}=\text{tantal } 1.0\mu\text{F}$ $t_r/t_f=5\mu\text{s}$ $T_{opt}=25^\circ\text{C}$

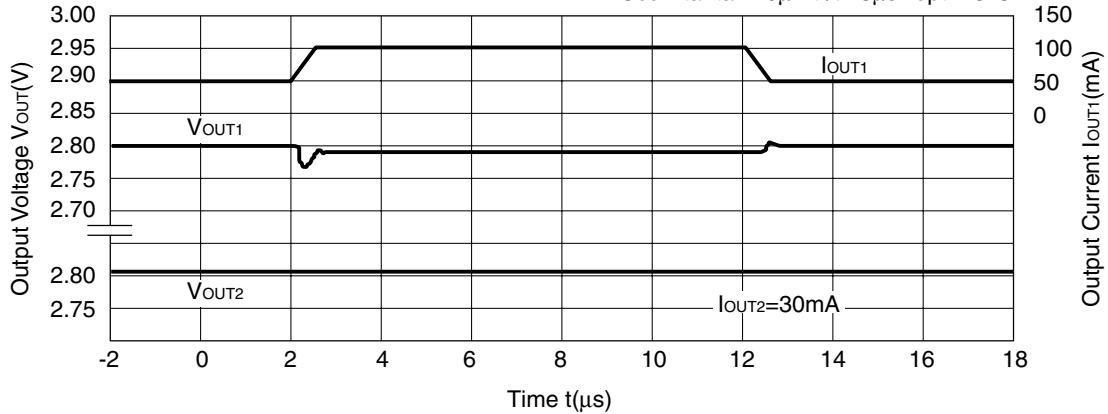

R5322N001x (VR1=2.8V)

$I_{OUT}=50\text{mA} \leftrightarrow 100\text{mA}$ $V_{IN}=3.8\text{V}$ $C_{IN}=\text{tantal } 1.0\mu\text{F}$
 $C_{OUT}=\text{tantal } 2.2\mu\text{F}$ $t_r/t_f=5\mu\text{s}$ $T_{opt}=25^\circ\text{C}$

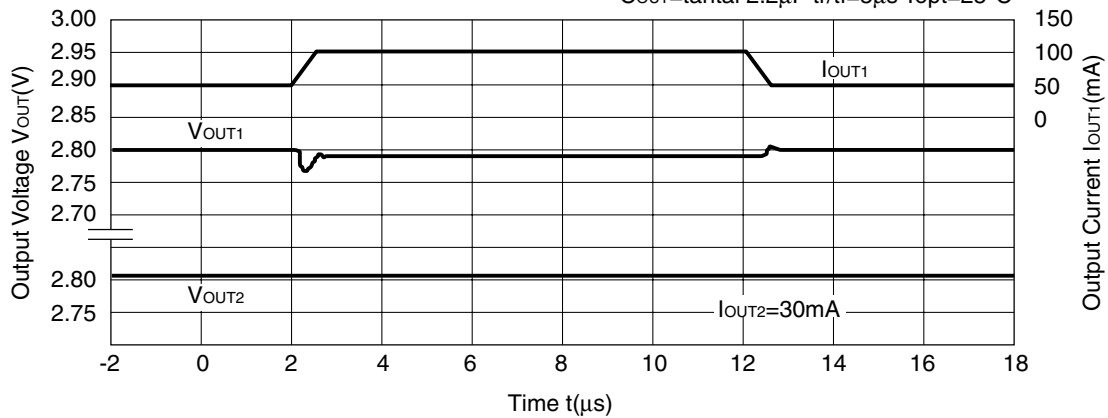

R5322N001x (VR1=2.8V)

$I_{OUT}=50\text{mA} \leftrightarrow 100\text{mA}$ $V_{IN}=3.8\text{V}$ $C_{IN}=\text{tantal } 1.0\mu\text{F}$
 $C_{OUT}=\text{tantal } 6.8\mu\text{F}$ $t_r/t_f=5\mu\text{s}$ $T_{opt}=25^\circ\text{C}$

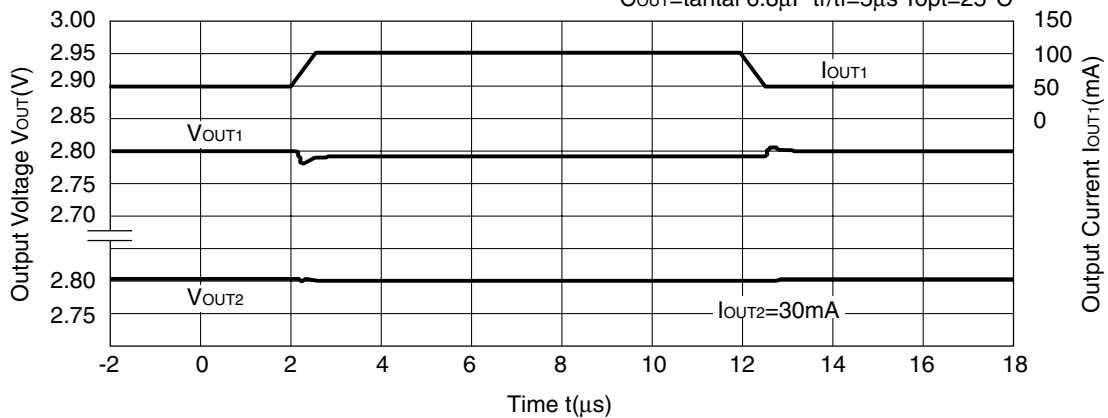

R5322N001x (VR2=2.8V)

$I_{OUT}=50mA \leftrightarrow 100mA$ $V_{IN}=3.8V$ $C_{IN}=\text{tantal } 1.0\mu F$
 $C_{OUT}=\text{tantal } 1.0\mu F$ $tr/tf=5\mu s$ $T_{opt}=25^{\circ}C$

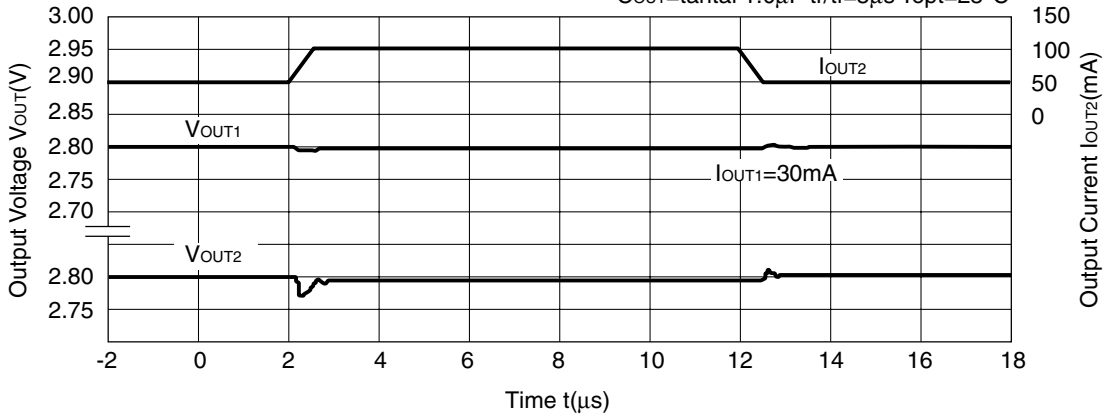

R5322N00x (VR2=2.8V)

$I_{OUT}=50mA \leftrightarrow 100mA$ $V_{IN}=3.8V$ $C_{IN}=\text{tantal } 1.0\mu F$
 $C_{OUT}=\text{tantal } 2.2\mu F$ $tr/tf=5\mu s$ $T_{opt}=25^{\circ}C$

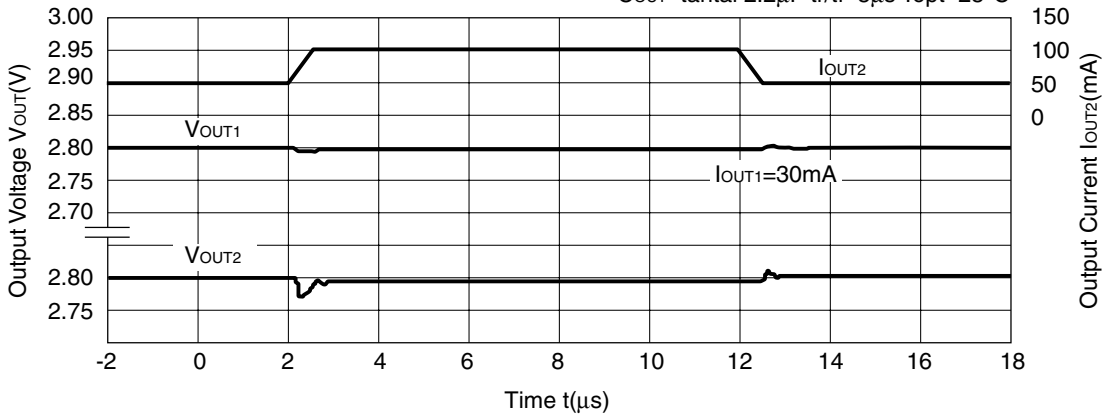

R5322N00x (VR2=2.8V)

$I_{OUT}=50mA \leftrightarrow 100mA$ $V_{IN}=3.8V$ $C_{IN}=\text{tantal } 1.0\mu F$
 $C_{OUT}=\text{tantal } 6.8\mu F$ $tr/tf=5\mu s$ $T_{opt}=25^{\circ}C$

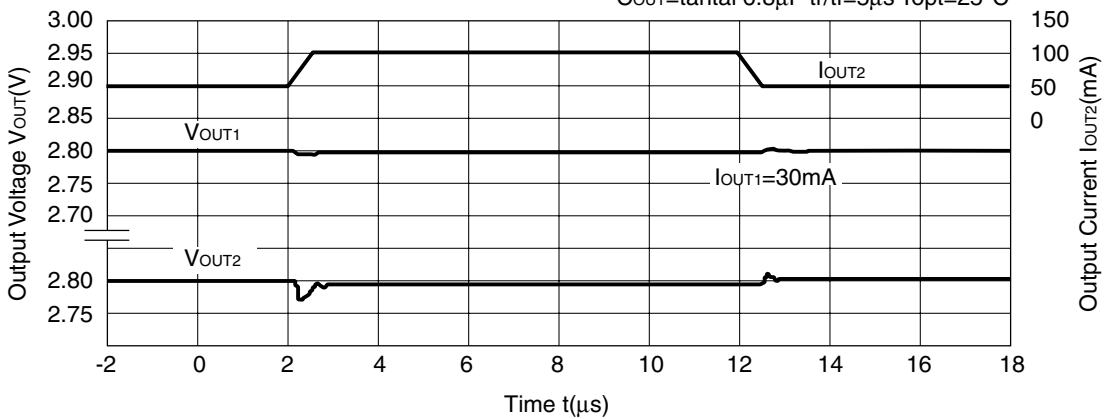

TECHNICAL NOTES

When using these ICs, consider the following points:

In these ICs, phase compensation is made for securing stable operation even if the load current is varied. For this purpose, be sure to use a $2.2\mu\text{F}$ or more capacitance C_{OUT} with good frequency characteristics and ESR (Equivalent Series Resistance) of which is in the range described as follows:

The relations between I_{OUT} (Output Current) and ESR of Output Capacitor are shown below. The conditions when the white noise level is under $40\mu\text{V}$ (Avg.) are marked as the hatched area in the graph.

(Note: When a ceramic capacitor is connected to the Output Pin as Output capacitor for phase compensation, the operation might be unstable unless as much as 1Ω resistor is connected between the capacitor and GND instead of ESR. Test these ICs with as same external components as ones to be used on the PCB.)

<Test conditions>

- (1) $V_{\text{IN}}=3.8\text{V}$
- (2) Frequency band: 10Hz to 2MHz
- (3) Temperature: 25°C

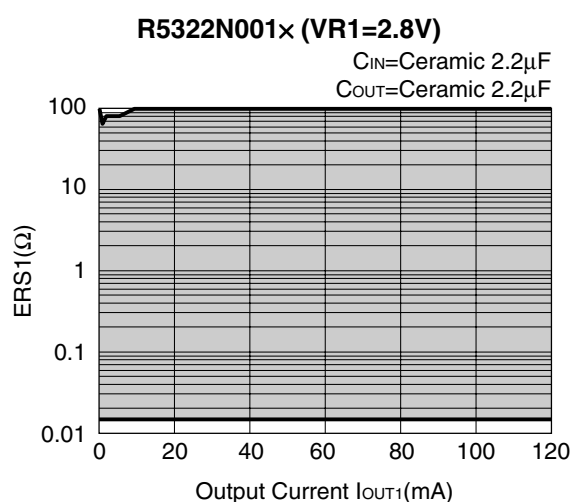
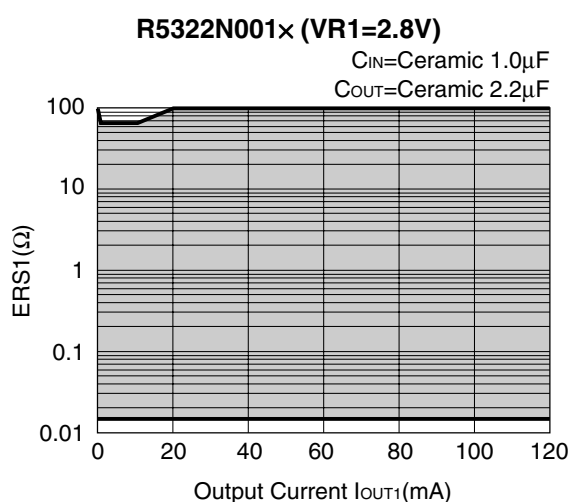

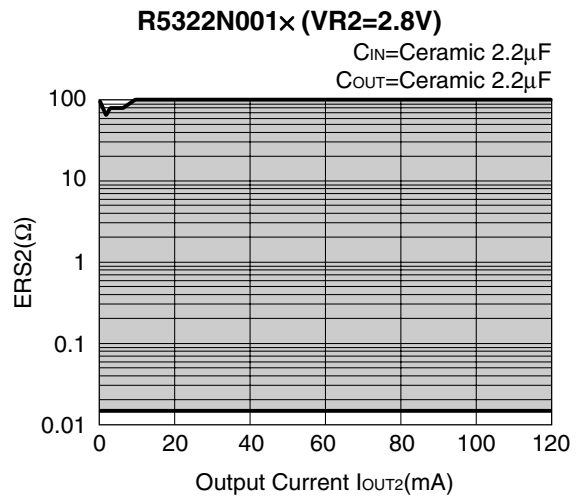
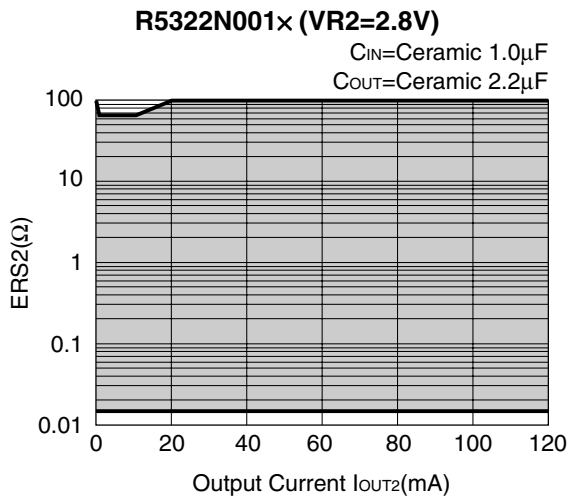

- Make V_{DD} and GND line sufficient. When the impedance of these is high, the noise might be picked up or not work correctly.
- Connect the capacitor with a capacitance of 1 μ F or more between V_{DD} and GND as close as possible.
- Set external components, especially Output Capacitor, as close as possible to the ICs and make wiring shortest.