



# STTH310/S

## HIGH VOLTAGE ULTRAFAST RECTIFIER

### MAIN PRODUCT CHARACTERISTICS

$I_{F(AV)}$	3 A
$V_{RRM}$	1000 V
$T_j(\text{max})$	175 °C
$V_F(\text{max})$	1.42 V

### FEATURES AND BENEFITS

- Low forward voltage drop
- High reliability
- High surge current capability
- Soft switching for reduced EMI disturbances
- Planar technology

### DESCRIPTION

The STTH310, which is using ST ultrafast high voltage planar technology, is specially suited for free-wheeling, clamping, snubbing, demagnetization in power supplies and other power switching applications.

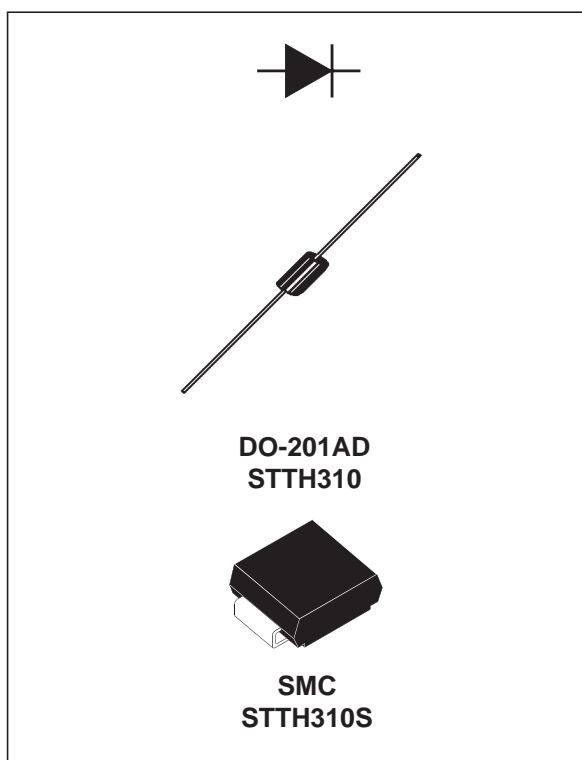

### ABSOLUTE RATINGS (limiting values)

Symbol	Parameter		Value	Unit	
$V_{RRM}$	Repetitive peak reverse voltage		1000	V	
$V_{(RMS)}$	RMS voltage		700	V	
$I_{F(AV)}$	Average forward current	$T_I = 75^\circ\text{C} \quad \delta = 0.5$	DO-201AD	3	A
		$T_I = 75^\circ\text{C} \quad \delta = 0.5$	SMC	3	
$I_{FSM}$	Forward surge current $t = 8.3 \text{ ms}$		DO-201AD	55	A
			SMC	45	
$T_{stg}$	Storage temperature range		- 50 + 175	°C	
$T_j$	Maximum operating junction temperature		+ 175	°C	

## THERMAL PARAMETERS

Symbol	Parameter			Value	Unit
R <sub>th(j-l)</sub>	Junction to lead	L = 10 mm	DO-201AD	20	°C/W
			SMC	20	
R <sub>th(j-a)</sub>	Junction to ambient	L = 10 mm	DO-201AD	75	

## STATIC ELECTRICAL CHARACTERISTICS

Symbol	Parameter	Tests conditions		Min.	Typ.	Max.	Unit
I <sub>R</sub>	Reverse leakage current	V <sub>R</sub> = 1000V	T <sub>j</sub> = 25°C			10	μA
			T <sub>j</sub> = 125°C			50	
V <sub>F</sub>	Forward voltage drop	I <sub>F</sub> = 3 A	T <sub>j</sub> = 25°C			1.7	V
			T <sub>j</sub> = 150°C		0.98	1.42	

To evaluate the maximum conduction losses use the following equation :

$$P = 1.20 \times I_{F(AV)} + 0.075 \times I_{F(RMS)}^2$$

## DYNAMIC ELECTRICAL CHARACTERISTICS

Symbol	Parameter	Tests conditions		Min.	Typ.	Max.	Unit
t <sub>rr</sub>	Reverse recovery time	I <sub>F</sub> = 0.5 A I <sub>rr</sub> = 0.25 A I <sub>R</sub> = 1A	T <sub>j</sub> = 25°C			75	ns
t <sub>fr</sub>	Forward recovery time	I <sub>F</sub> = 3 A dI <sub>F</sub> /dt = 50 A/μs V <sub>FR</sub> = 1.1 x V <sub>F</sub> max	T <sub>j</sub> = 25°C			300	ns
V <sub>FP</sub>	Forward recovery voltage						12

**Fig. 1:** Conduction losses versus average current.

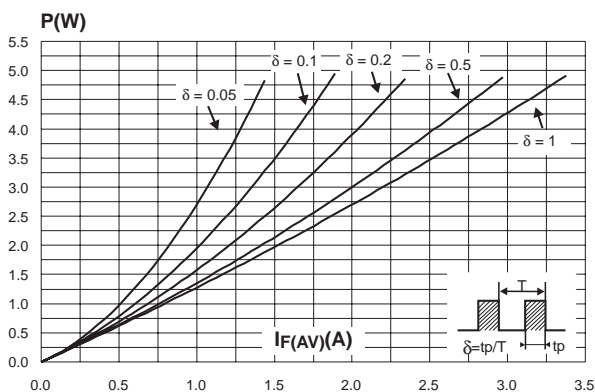

**Fig. 2:** Forward voltage drop versus forward current.

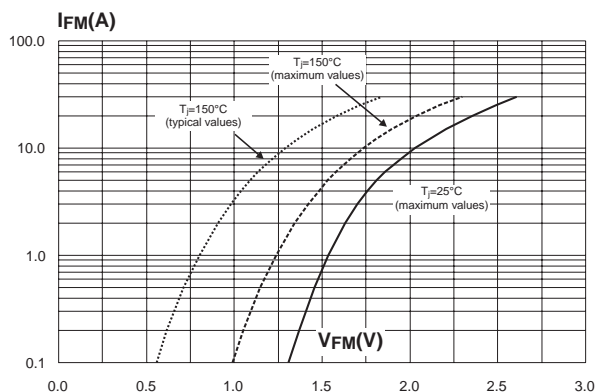

**Fig. 3-1:** Relative variation of thermal impedance junction ambient versus pulse duration (epoxy FR4,  $L_{leads} = 10\text{mm}$ ) (DO-201AD).

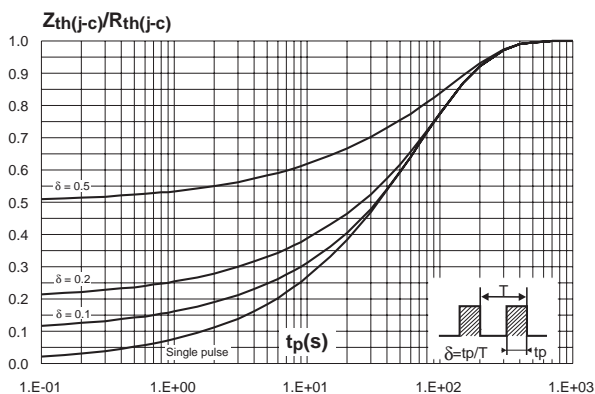

**Fig. 3-2:** Relative variation of thermal impedance junction ambient versus pulse duration (epoxy FR4,  $S=1\text{cm}^2$ ) (SMC).

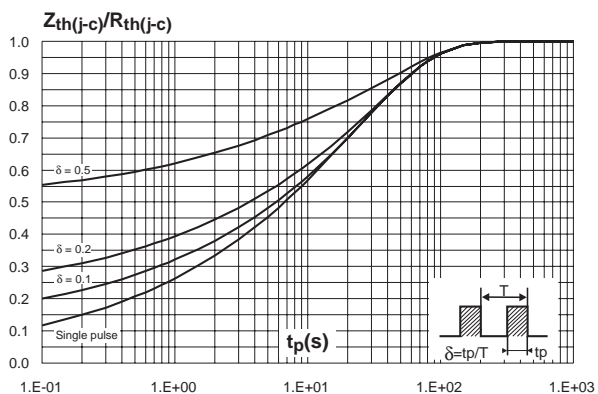

**Fig. 4:** Thermal resistance junction to ambient versus copper surface under each lead (epoxy printed circuit board FR4, copper thickness:  $35\mu\text{m}$ ).

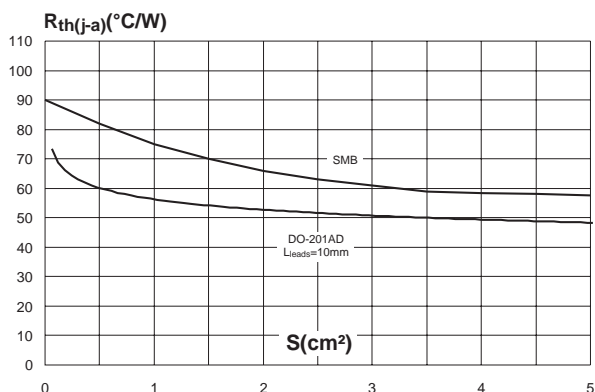

PACKAGE MECHANICAL DATA  
SMC

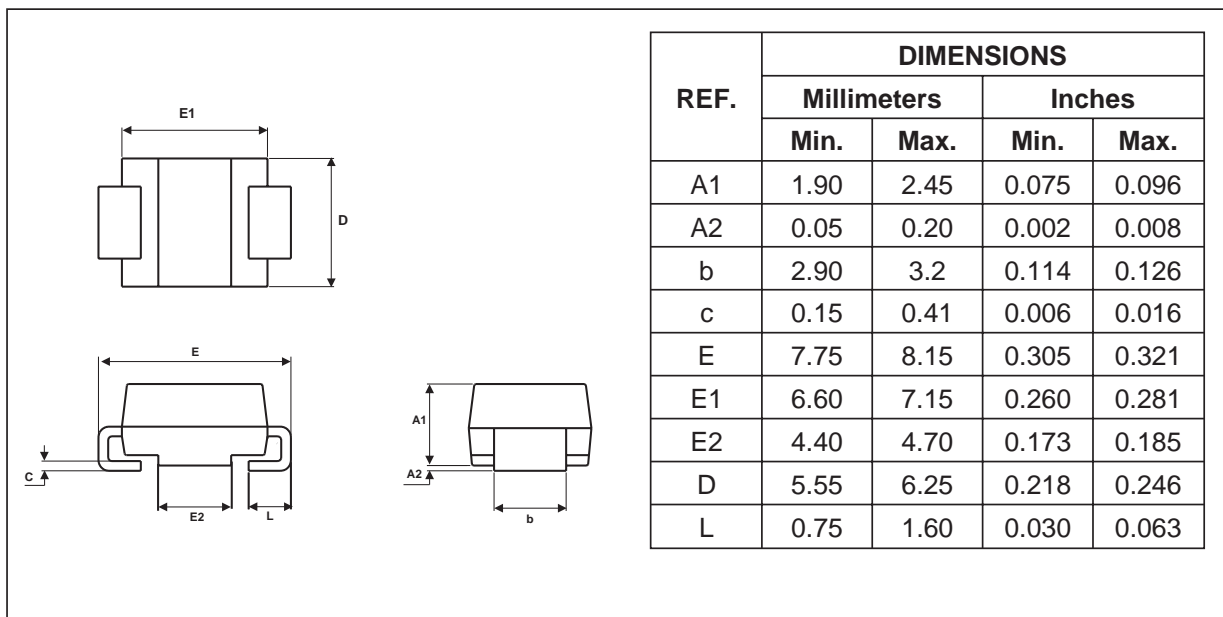

FOOTPRINT (in millimeters)

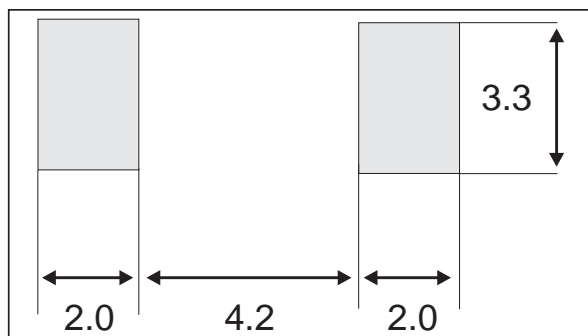

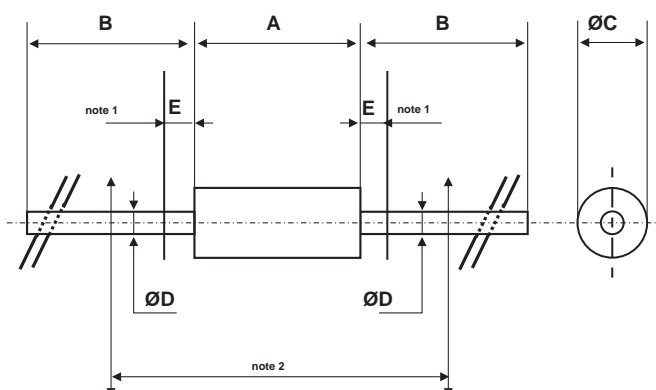
**PACKAGE MECHANICAL DATA**  
 DO-201AD

REF.	DIMENSIONS				NOTES
	Millimeters		Inches		
	Min.	Max.	Min.	Max.	
A		9.50		0.374	1 - The lead diameter $\varnothing D$ is not controlled over zone E 2 - The minimum length which must stay straight between the right angles after bending is 0.59"(15 mm)
B	25.40		1.000		
C		5.30		0.209	
D		1.30		0.051	
E		1.25		0.049	

Ordering code	Marking	Package	Weight	Base qty	Delivery mode
STTH310	STTH310	DO-201AD	1.12 g	600	Ammopack
STTH310S	S10	SMC	0.245 g	2500	Tape & reel
STTH310RL	STTH310	DO-201AD	1.12 g	1900	Tape & reel

- Epoxy meets UL 94,V0

Information furnished is believed to be accurate and reliable. However, STMicroelectronics assumes no responsibility for the consequences of use of such information nor for any infringement of patents or other rights of third parties which may result from its use. No license is granted by implication or otherwise under any patent or patent rights of STMicroelectronics. Specifications mentioned in this publication are subject to change without notice. This publication supersedes and replaces all information previously supplied. STMicroelectronics products are not authorized for use as critical components in life support devices or systems without express written approval of STMicroelectronics.

The ST logo is a registered trademark of STMicroelectronics

© 2003 STMicroelectronics - Printed in Italy - All rights reserved.

STMicroelectronics GROUP OF COMPANIES

Australia - Brazil - Canada - China - Finland - France - Germany  
 Hong Kong - India - Israel - Italy - Japan - Malaysia - Malta - Morocco - Singapore  
 Spain - Sweden - Switzerland - United Kingdom - United States.

<http://www.st.com>