



**SF1001G- SF1008G**  
**10.0AMPS. Glass Passivated Super Fast Rectifiers**  
**TO-220AB**

**Features**

- ◇ High efficiency, low VF
- ◇ High current capability
- ◇ High reliability
- ◇ High surge current capability
- ◇ Low power loss.
- ◇ For use in low voltage, high frequency inverter, free wheeling, and polarity protection application
- ◇ Green compound with suffix "G" on packing code & prefix "G" on datecode.

**Mechanical Data**

- ◇ Case: TO-220AB Molded plastic
- ◇ Epoxy: UL 94V-0 rate flame retardant
- ◇ Terminals: Pure tin plated, lead free, solderable per MIL-STD-202, Method 208 guaranteed
- ◇ Polarity: As marked
- ◇ High temperature soldering guaranteed: 260°C/10 seconds 16" (4.06mm) from case.
- ◇ Weight: 1.82 grams

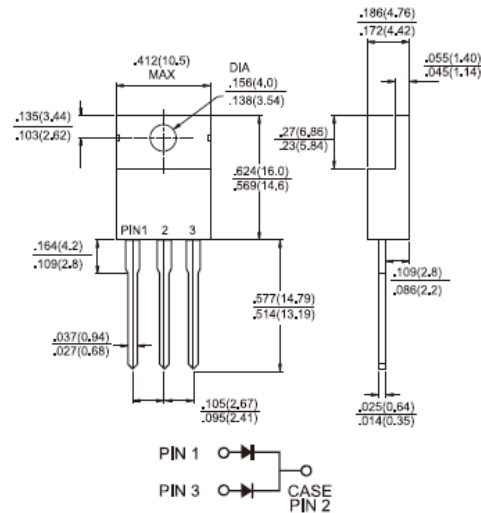

**Dimensions in inches and (millimeters)**

**Marking Diagram**

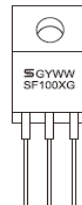

- SF100XG = Specific Device Code
- G = Green Compound
- Y = Year
- WW = Work Week

**Maximum Ratings and Electrical Characteristics**

Rating at 25 °C ambient temperature unless otherwise specified.

Single phase, half wave, 60 Hz, resistive or inductive load.

For capacitive load, derate current by 20%

Type Number	Symbol	SF 1001G	SF 1002G	SF 1003G	SF 1004G	SF 1005G	SF 1006G	SF 1007G	SF 1008G	Units
Maximum Recurrent Peak Reverse Voltage	$V_{RRM}$	50	100	150	200	300	400	500	600	V
Maximum RMS Voltage	$V_{RMS}$	35	70	105	140	210	280	350	420	V
Maximum DC Blocking Voltage	$V_{DC}$	50	100	150	200	300	400	500	600	V
Maximum Average Forward Rectified Current	$I_{F(AV)}$	10								A
Peak Forward Surge Current, 8.3 ms Single Half Sine-wave Superimposed on Rated Load (JEDEC method)	$I_{FSM}$	125								A
Maximum Instantaneous Forward Voltage (Note 1) @ 5 A	$V_F$	0.975			1.3		1.7			V
Maximum DC Reverse Current @ $T_A=25\text{ }^\circ\text{C}$ at Rated DC Blocking Voltage @ $T_A=100\text{ }^\circ\text{C}$	$I_R$	10				400				uA uA
Maximum Reverse Recovery Time (Note 2)	$T_{rr}$	35								nS
Typical Junction Capacitance (Note 3)	$C_j$	70				50				pF
Typical Thermal Resistance	$R_{\theta JC}$	3.5								°C/W
Operating Temperature Range	$T_J$	- 65 to + 150								°C
Storage Temperature Range	$T_{STG}$	- 65 to + 150								°C

Note 1: Pulse Test with PW=300 usec, 1% Duty Cycle

Note 2: Reverse Recovery Test Conditions:  $I_F=0.5A$ ,  $I_R=1.0A$ ,  $I_{RR}=0.25A$ .

Note 3: Measured at 1 MHz and Applied Reverse Voltage of 4.0 V D.C.

## RATINGS AND CHARACTERISTIC CURVES (SF1001G THRU SF1008G)

FIG. 1- MAXIMUM FORWARD CURRENT DERATING CURVE

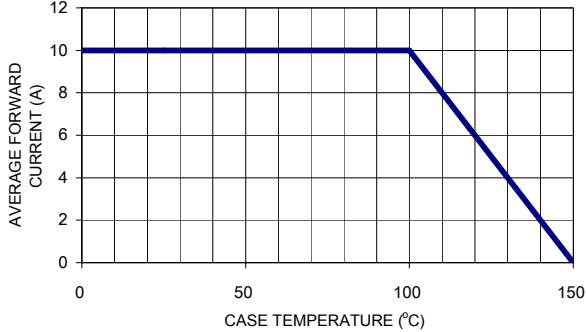

FIG. 2- TYPICAL REVERSE CHARACTERISTICS

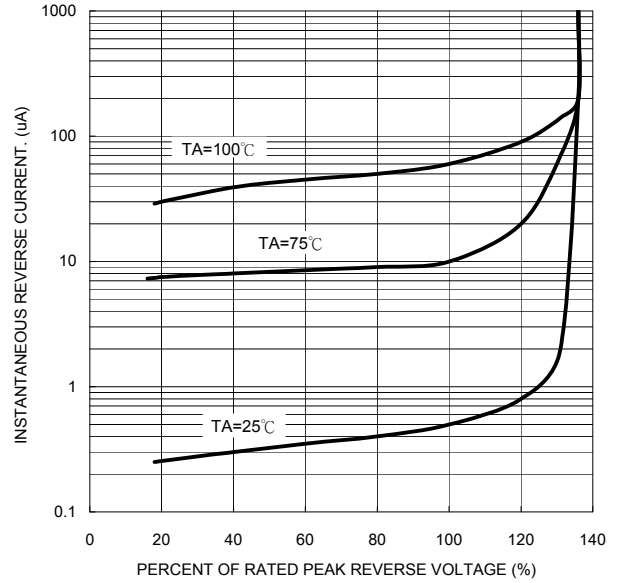

FIG. 3- MAXIMUM NON-REPETITIVE FORWARD SURGE CURRENT PER LEG

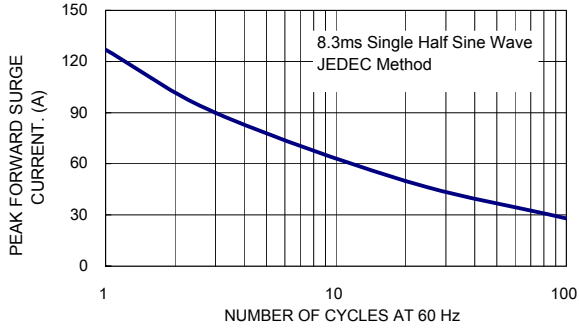

FIG. 5- TYPICAL FORWARD CHARACTERISTICS PER LEG

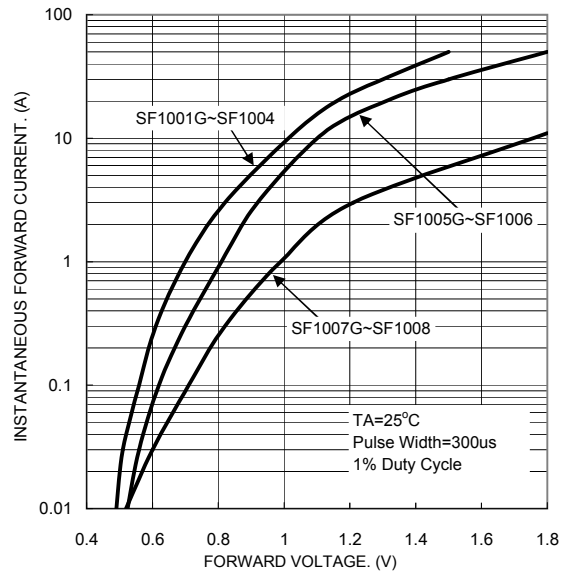

FIG. 4- TYPICAL JUNCTION CAPACITANCE PER LEG

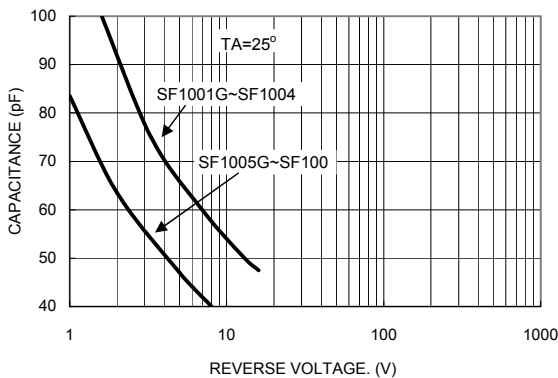
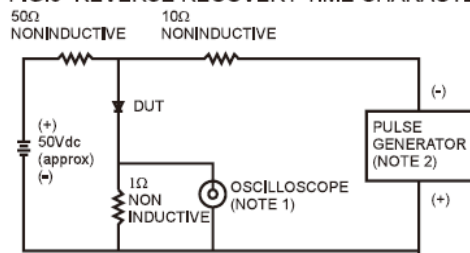

FIG. 6- REVERSE RECOVERY TIME CHARACTERISTIC AND TEST CIRCUIT DIAGRAM



NOTES: 1. Rise Time=7ns max. Input Impedance=1 megohm 22pf  
2. Rise Time=10ns max. Source Impedance=50 ohms

