



LA4581MB

Preamplifier + Power Amplifier for 3V Headphone Stereos

Overview

The LA4581MB is an auto reverse-supported preamplifier + power amplifier IC that is intended for use in 3V headphone stereos.

Features

- Preamplifier muting and preamplifier output on/off can be implemented with one pin. This IC can easily be used to construct a set with a radio.
- The power amplifier needs no input/output coupling capacitor.
- A high-frequency cut capacitor is connected to the preamplifier input pin and the power amplifier input pin. (Anti-buzz provision)
- Because V_{ref} AMP ($r_0 = 10 \Omega$) is built in, the virtual grounding impedance is about 10Ω . This eliminates the need for a large capacitor.
- 8Ω speaker drivable.

Package Dimensions

unit : mm

3112-MFP24S

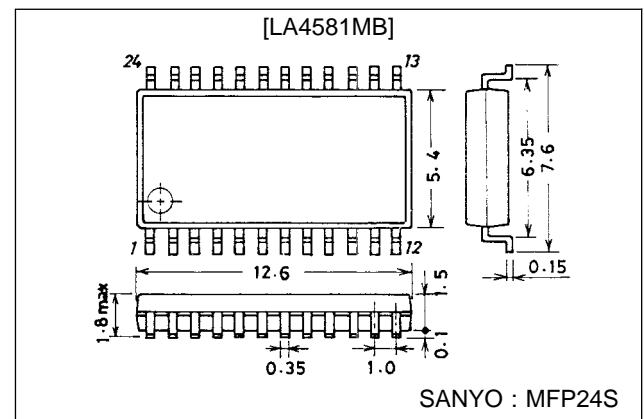

Specifications

Maximum Ratings at $T_a = 25^\circ\text{C}$

Parameter	Symbol	Conditions	Ratings	Unit
Maximum supply voltage	V_{CC} max		4.5	V
Allowable power dissipation	P_d max		530	mW
Operating temperature	T_{opr}		-20 to +75	$^\circ\text{C}$
Storage temperature	T_{stg}		-40 to +125	$^\circ\text{C}$

Operating Conditions at $T_a = 25^\circ\text{C}$

Parameter	Symbol	Conditions	Ratings	Unit
Recommended supply voltage	V_{CC}		3.0	V
Operating supply voltage range	V_{CC} op		1.8 to 3.6	V

■ Any and all SANYO products described or contained herein do not have specifications that can handle applications that require extremely high levels of reliability, such as life-support systems, aircraft's control systems, or other applications whose failure can be reasonably expected to result in serious physical and/or material damage. Consult with your SANYO representative nearest you before using any SANYO products described or contained herein in such applications.

■ SANYO assumes no responsibility for equipment failures that result from using products at values that exceed, even momentarily, rated values (such as maximum ratings, operating condition ranges, or other parameters) listed in products specifications of any and all SANYO products described or contained herein.

LA4581MB

**Operating Characteristics at $T_a = 25\text{ }^\circ\text{C}$, $V_{CC} = 3.0\text{ V}$, $f = 1\text{ kHz}$, $0.775\text{ V} = 0\text{ dBm}$,
 $R_L = 10\text{ k}\Omega$ (preamplifier), $R_L = 16\text{ }\Omega$ (power amplifier)**

Parameter	Symbol	Output	min	typ	max	Unit
[Pre + Power]						
Quiescent current	I_{CCO}	$R_g = 2.2\text{ k}\Omega$ (preamplifier) $V_{IN} = 0\text{ V}$		17	27	mA
Voltage gain (Closed)	VG_T	$V_O = -5\text{ dBm}$	65	68	71	dB
[Preamplifier]						
Voltage gain (Open)	VG_o	$V_O = -5\text{ dBm}$	70	80		dB
Voltage gain (Closed)	VG_1	$V_O = -5\text{ dBm}$		40		dB
Maximum output voltage	V_{Omax}	THD = 1 %, $V_{CC} = 1.8\text{ V}$	0.1	0.2		V
Total harmonic distortion	THD1	$V_O = 0.2\text{ V}$, $VG = 40\text{ dB/NAB}$		0.05	0.5	%
Equivalent input noise voltage	V_{N1}	$R_g = 2.2\text{ k}\Omega$, B.P.F = 20 to 20 kHz		1.3	2.0	μV
Crosstalk	CT1	$R_g = 2.2\text{ k}\Omega$, TUNE 1 kHz	60	80		dB
Ripple rejection ratio	R_{r1}	$R_g = 2.2\text{ k}\Omega$, $V_{CC} = 1.8\text{ V}$, $V_r = -20\text{ dBm}$, $f = 100\text{ Hz}$	40	50		dB
[Power Amplifier]						
Output voltage	P_O	THD = 10%	23	32		mW
Voltage gain (Closed)	VG_2	$V_O = -5\text{ dBm}$	25	28	31	dB
Total harmonic distortion	THD2	$P_O = 1\text{ mW}$		0.4	1.0	%
Interchannel crosstalk	CT _T	$V_O = -5\text{ dBm}$, $R_v = 0\text{ }\Omega$	30	40		dB
Output noise voltage	V_{NO}	$R_g = 0$, B.P.F = 20 to 20 kHz		24	40	μV
Ripple rejection ratio	R_{r2}	$R_g = 0$, $V_r = -20\text{ dB}$, $f = 100\text{ Hz}$, $V_{CC} = 1.8\text{ V}$	45	60		dB
Input resistance	R_{IN}		22	30	38	k Ω
DC offset voltage	V_{ODCoff}	Between 13-14 and 15	-90		+90	mV

Note) Power amplifier voltage gain VG_2 increases by about 1 dB for min/max respectively than specified above when $R_L = 32\text{ }\Omega$.

LA4581MB

Block Diagram

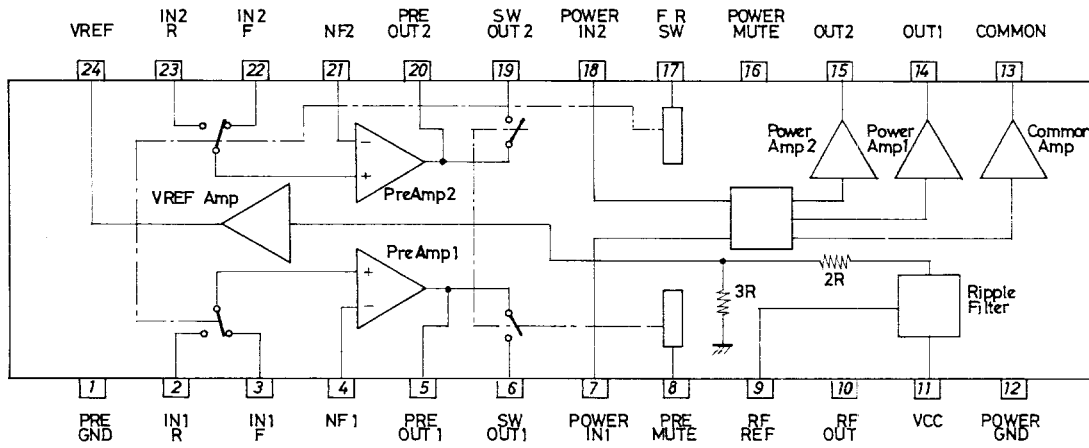

Test Circuit

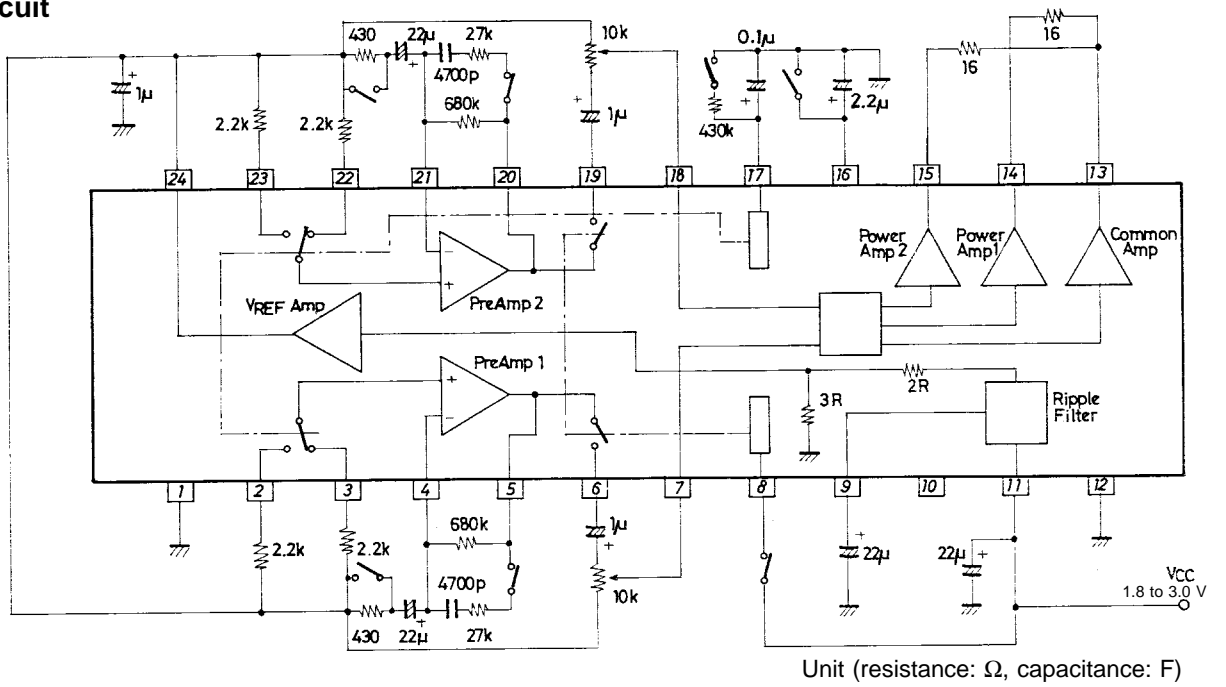

LA4581MB

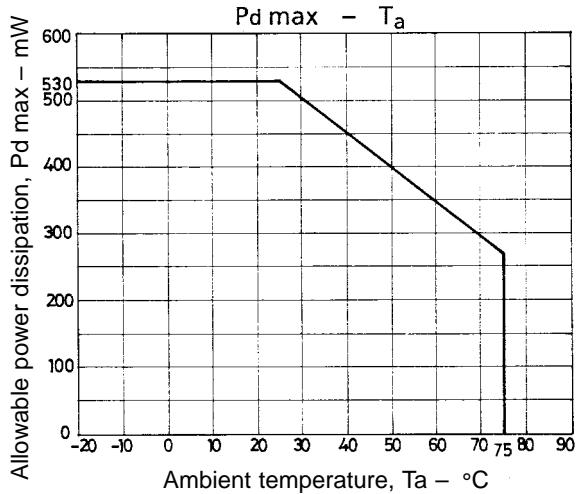

Sample Application Circuit

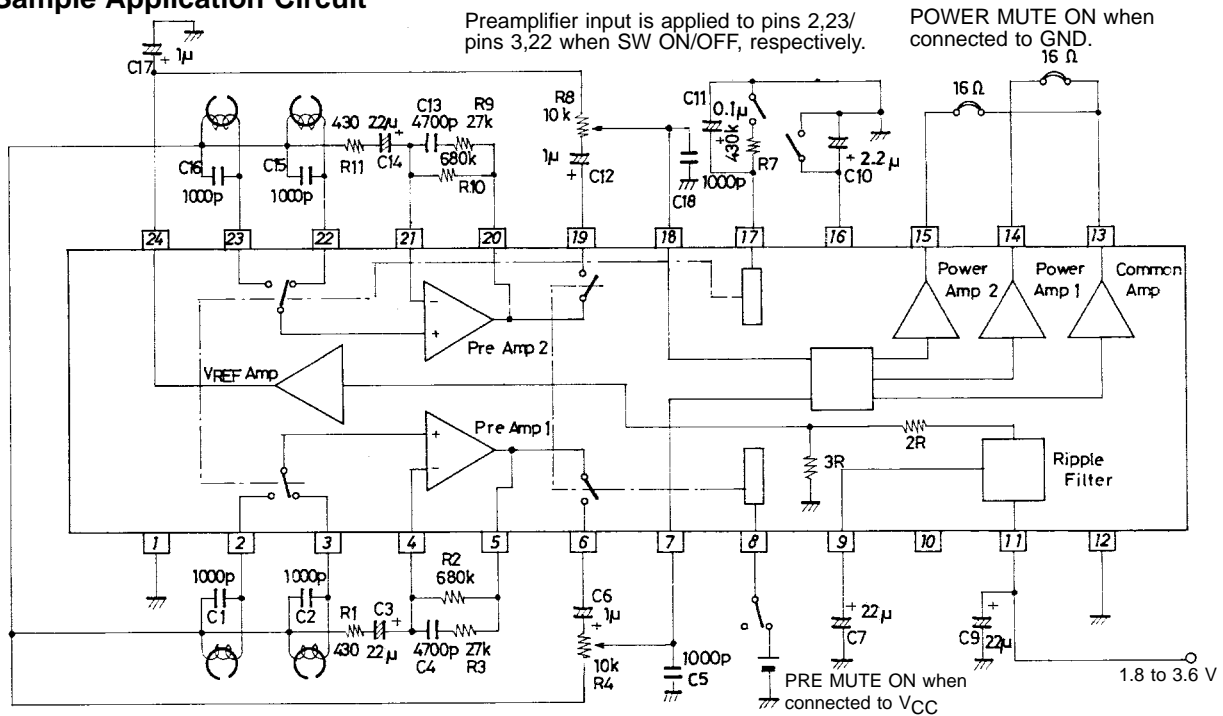

Note) Pre closed loop gain VG = 40 dB/1 kHz NAB

Unit (resistance: Ω, capacitance: F)

Pin and external part functions (when the voltage is V_{CC} = 3.0 V)

Pin No.	Pin Function
1	PRE GND
2	PRE IN1R 1.8 V • Turns ON when pin 17 is grounded. • A bias resistor (2.2 kΩ) must be connected between pin 2 and pin 24 (V _{ref}) when no head is in use.
3	PRE IN1F 1.8 V • Turns ON when pin 17 is floating. • A bias resistor (2.2 kΩ) must be connected between pin 3 and pin 24 (V _{ref}) when no head is in use.
4	PRE NF1 1.8 V
5	PRE OUT1 1.8 V • Like pin 6, 10 kΩ load drivable.
6	SW OUT1 1.8V • Provides PRE AMP1 output when pin 8 is floating (PRE MUTE OFF)(equivalent to pin 5). • Disconnects from PRE AMP1 and sets R _{IN} ≥ 500 kΩ when pin 8 is at V _{CC} (PRE MUTE ON).
7	POWER IN1 1.8V • Input resistance R _{IN} = 30 kΩ

Continued on next page.

LA4581MB

Continued from preceding page.

Pin No.	Pin Function
8	PRE MUTE <ul style="list-style-type: none"> When V_{CC} is applied, PRE MUTE ON. MUTE ON conditions: $V_{8IN} \cong V_{CC} - 0.2$ V, inflow current $I_7 \cong 60$ μA (when $V_{CC} = 3$ V)
9	Ripple Filter REF 2.7 V ($C_7 = 2.2$ μ F to 33 μ F) <ul style="list-style-type: none"> Ripple Filter, V_{ref} reference The V_{ref} ripple rejection ratio worsens when C_7 is made smaller. R_r is 55 dB for 22 μF; 35 dB for 2.2 μF.
10	Ripple Filter OUT 2.7 V <ul style="list-style-type: none"> Ripple rejection ratio: R_r is 38 dB when $C_7 = 22$ μF; 30 dB when $C_7 = 2.2$ μF. Outflow current I_7 max = 1 mA
11	V_{CC} 3.0 V
12	POWER GND
13	COMMON 1.2 V
14	POWER OUT1 1.2 V <ul style="list-style-type: none"> CH1 output.
15	POWER OUT2 1.2 V <ul style="list-style-type: none"> CH2 output
16	POWER MUTE 0.7 V ($C_{10} = 1.0$ μ F to 4.7 μ F) <ul style="list-style-type: none"> When connected to GND: POWER MUTE ON. MUTE ON conditions: $V_{16} \leq 0.3$ V, outflow current $I_{16} \cong 2.5$ μA. C_{10} can be used to control MUTE TIME. When $C_{10} = 2.2$ μF, $V_{CC} = 3.0$ V 0.7 sec.
17	FWD/REV SW ($C_{11} \leq 0.47$ μ F) <ul style="list-style-type: none"> When connected to GND, PRE IN1R (pin 2) and IN2R (pin 23) turn on. When floating, PRE IN1F (pin 3) and IN2F (pin 22) turn on. C_{11} and R_7 are intended for smoothing at the time of switching. REV condition: $V_{17} \leq 0.2$ V.
18	POWER IN2 1.8 V <ul style="list-style-type: none"> Input resistance $R_{IN} \cong 30$ kΩ
19	SW OUT2 1.8 V <ul style="list-style-type: none"> Provides PRE AMP2 when pin 8 is floating (PRE MUTE OFF) (equivalent to pin 20). Disconnects from PRE AMP2 and $R_{IN} \geq 500$ kΩ when pin 8 is V_{CC} (PRE MUTE ON).
20	PRE OUT2 1.8 V <ul style="list-style-type: none"> Like pin 19, 10 kΩ load drivable.
21	PRE NF2 1.8V
22	PRE IN2F 1.8 V <ul style="list-style-type: none"> Turns on when pin 17 is floating. A bias resistor (2.2 kΩ) must be connected between pin 22 and pin 24 (V_{ref}) when no head is in use.
23	PRE IN2R 1.8 V <ul style="list-style-type: none"> Turns on when pin 17 is connected to GND. A bias resistor (2.2 kΩ) must be connected between pin 23 and pin 24 (V_{ref}) when no head is in use.
24	V_{ref} 1.8 V <ul style="list-style-type: none"> The reference voltage is set to $3/5 \times V_{CC}$. Because V_{ref} AMP ($r_O \cong 10$ Ω) is built in, C_{17} can be made smaller (1 μF). Inflow/outflow current $I_{24} = \pm 500$ μA available.

Sample Application:

Radio set application.

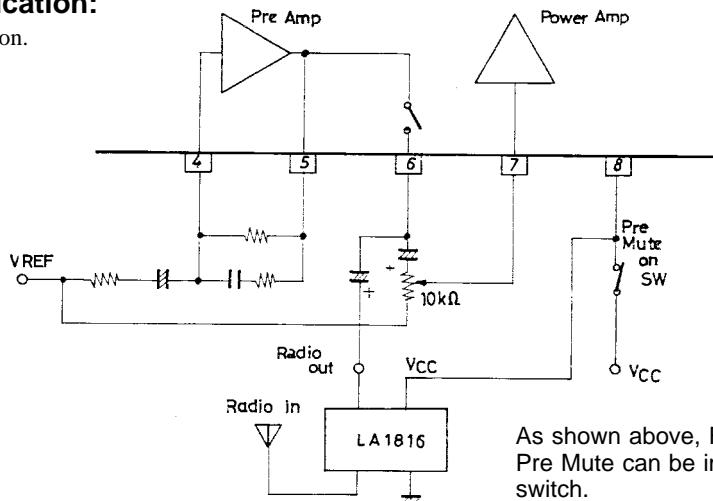

IC Usage Notes

- The power amplifier outputs and the common amplifier output are connected through resistors of about 60 Ω. The resistors are for common amplifier oscillation blocking.

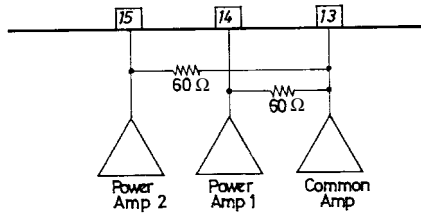

- The preamplifier muting function isolates the preamplifier outputs from SW OUT. The preamplifier is on even when the preamplifier muting is on.
- If transient noise is noticeable when the power supply is turned off, add the external circuit described below. Transient noise when the power is turned off can be improved by rapidly applying the power amplifier muting.

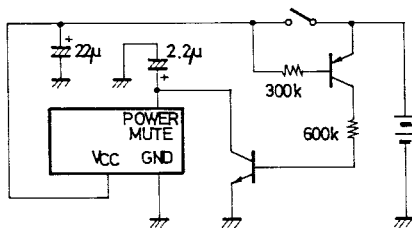

Unit (resistance: Ω, capacitance: F)

However, the standby current I_{ST} flows even when the power switch is off
 $I_{ST} = (V_{CC} - V_{BE})/600 \text{ k}\Omega$
 When $V_{CC} = 3.0 \text{ V}$
 $I_{ST} = (3.0 - 0.6)/600 \text{ k}\Omega \approx 4 \mu\text{A}$

- Internal equivalent circuit for each SW pin.

• Pre-mute

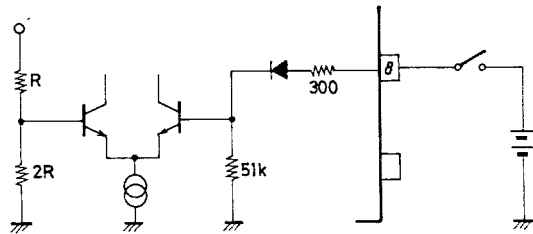

Unit (resistance: Ω)

MUTE ON condition : $V_{8IN} \geq V_{CC} - 0.2 \text{ V}$
 Inflow current : $I_8 \approx 60 \mu\text{A}$ (when $V_{CC} = 3.0 \text{ V}$)

• Power mute

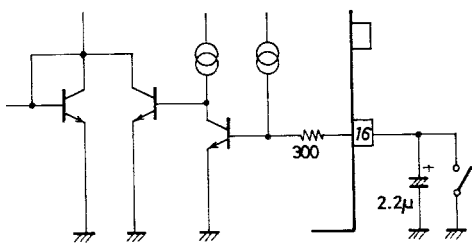

Unit (resistance: Ω, capacitance: F)

MUTE ON condition : $V_{16} \leq 0.3 \text{ V}$
 Outflow current : $I_{16} \approx 2.5 \mu\text{A}$

• F/R SW

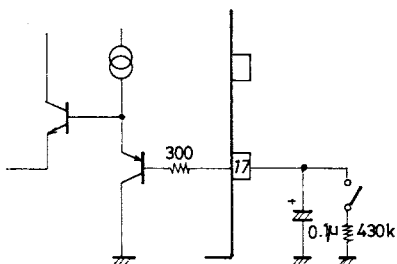

Unit (resistance: Ω, capacitance: F)

REV condition : $V_{17} \leq 0.2 \text{ V}$

LA4581MB

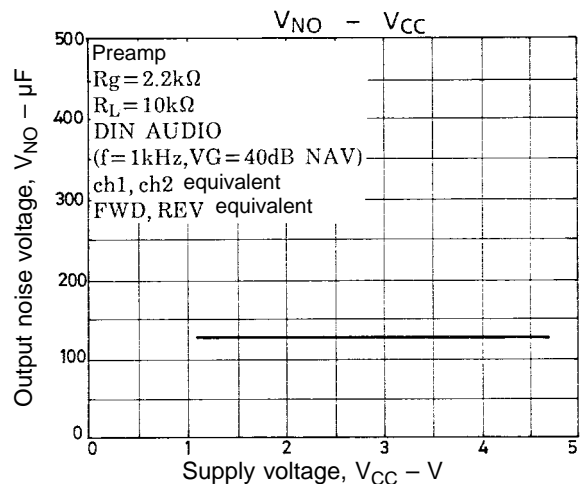
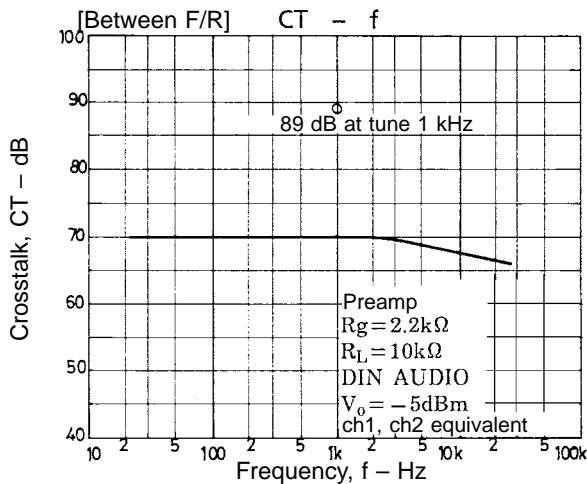
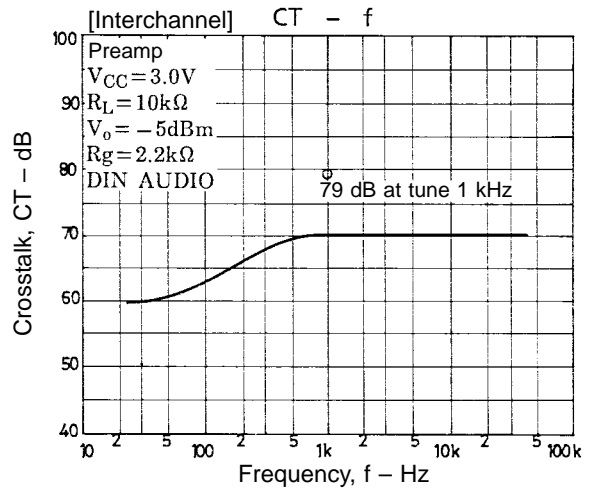
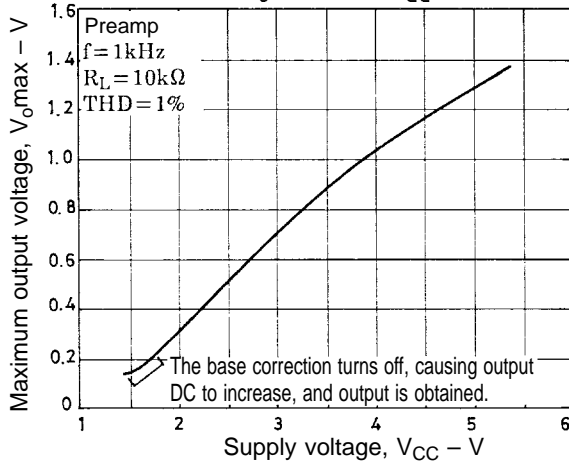
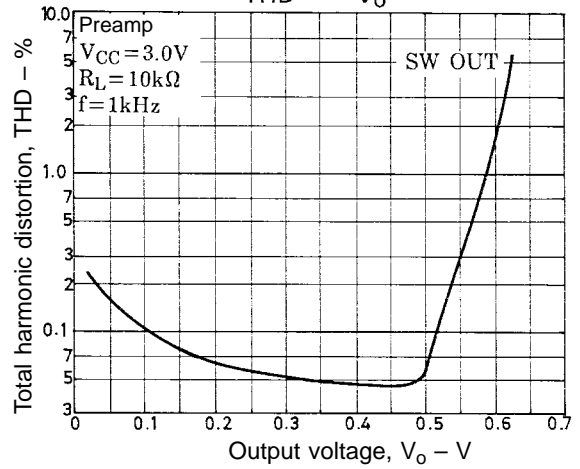
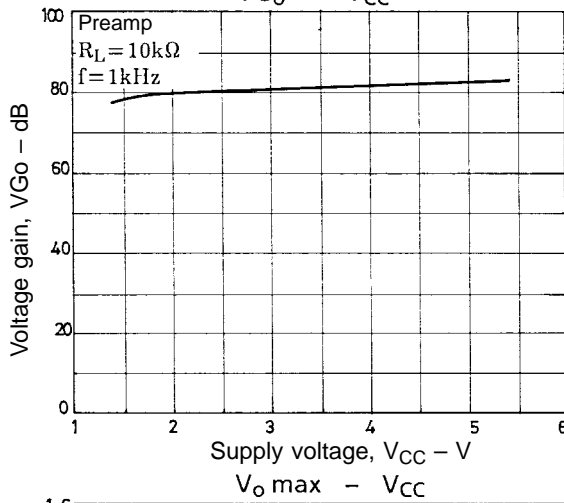
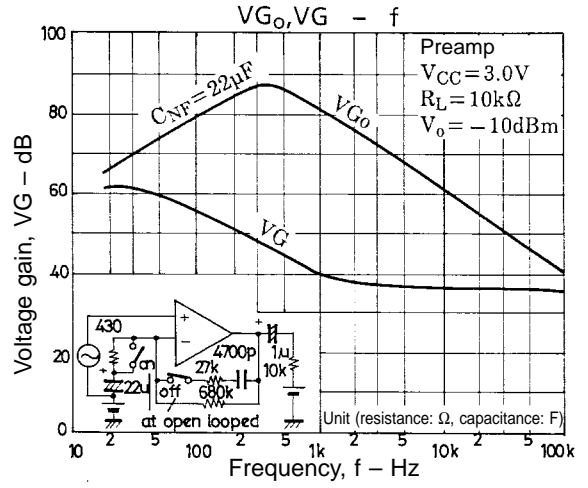
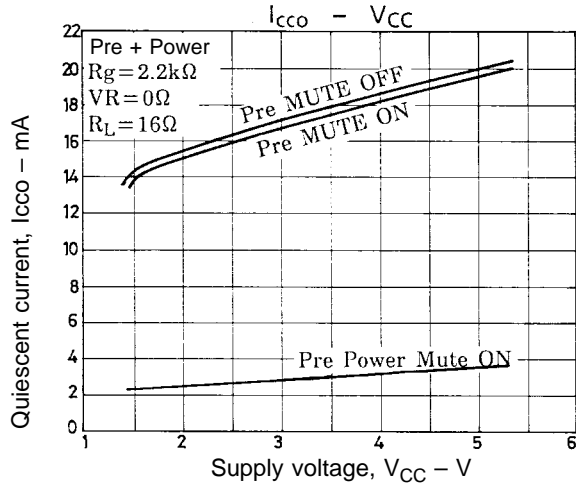

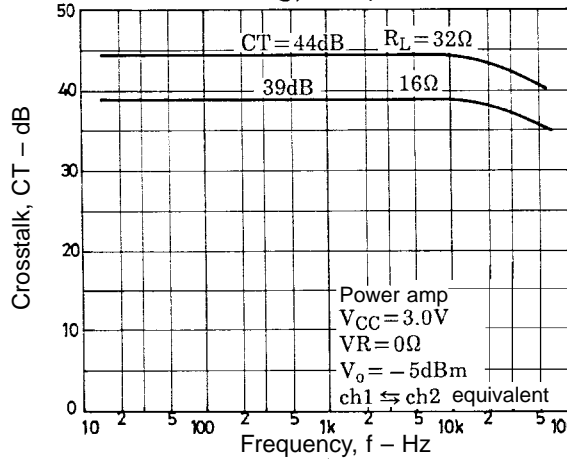
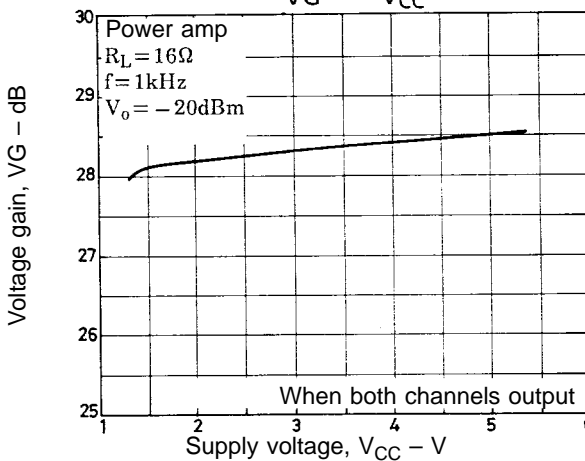
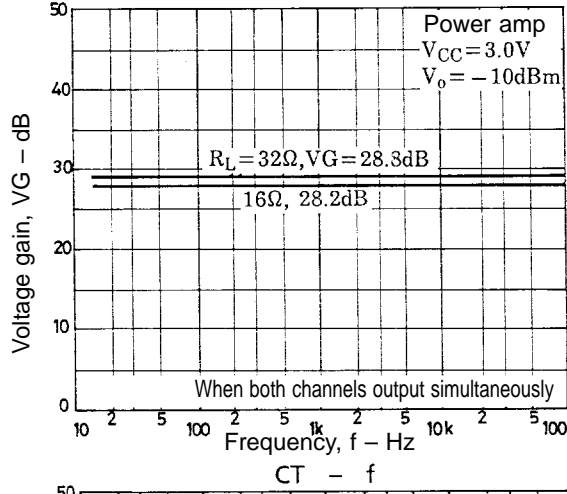
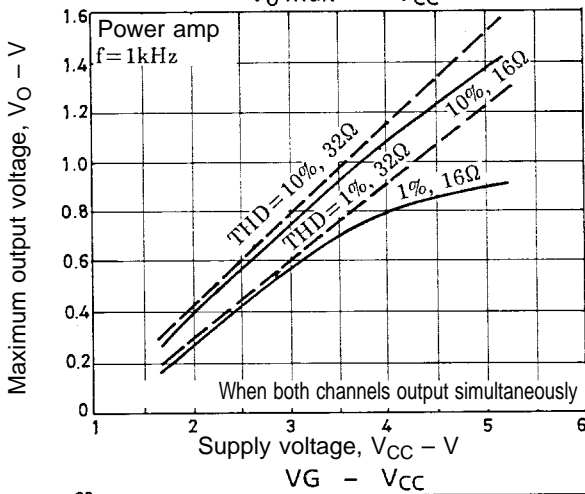
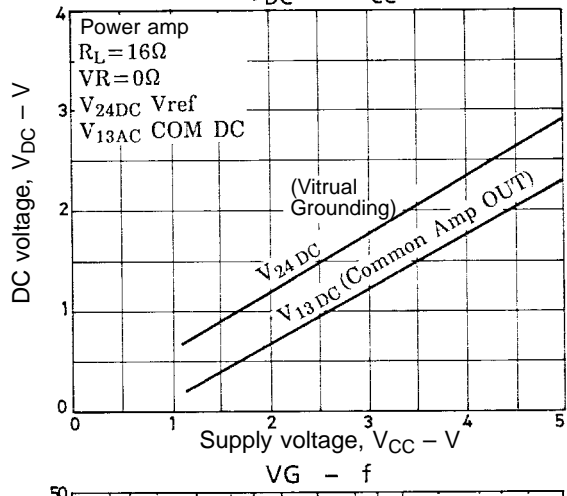
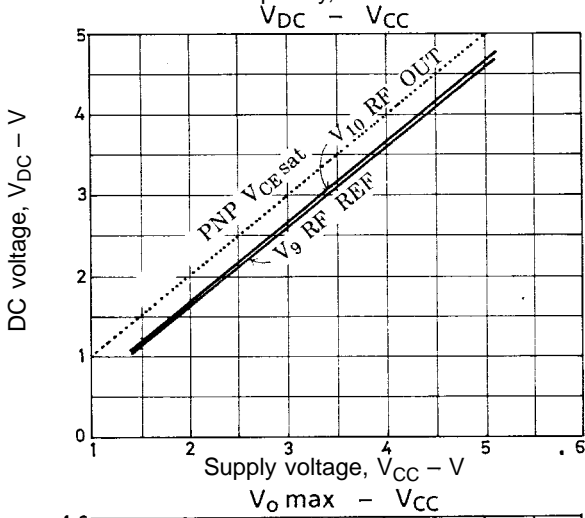
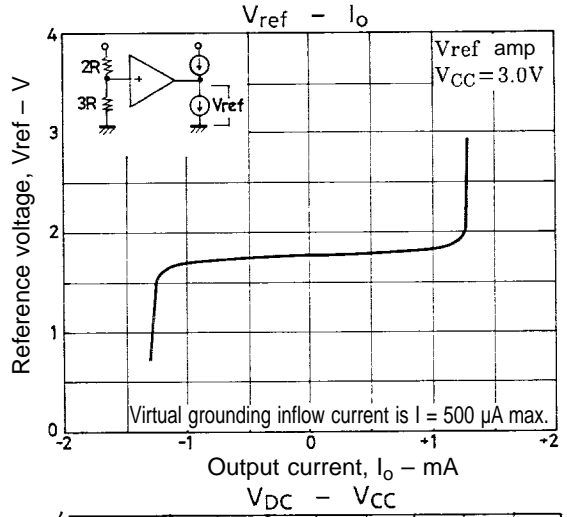
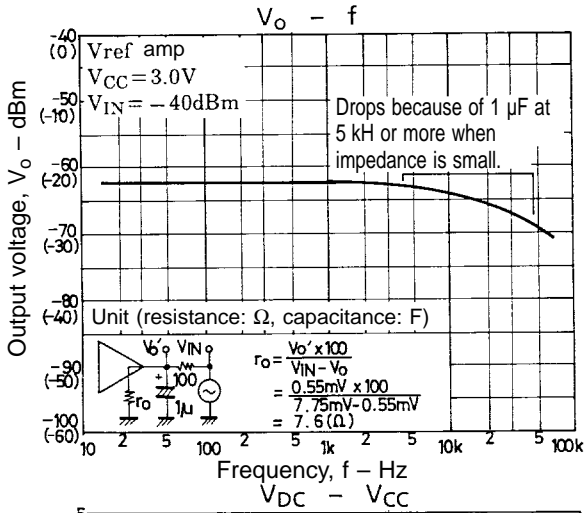

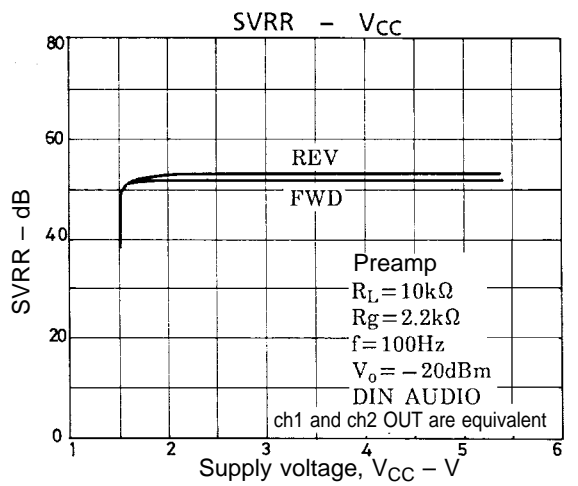
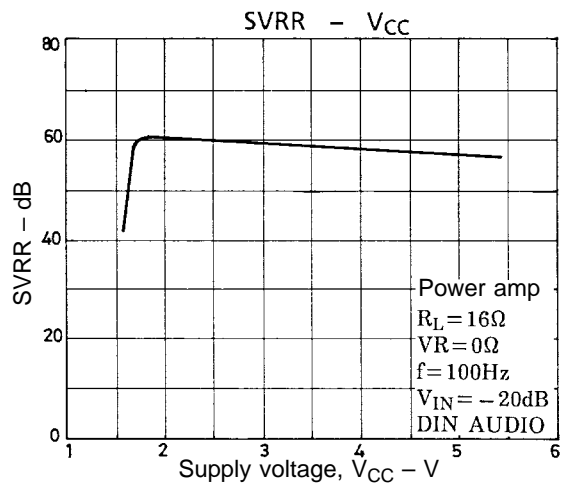
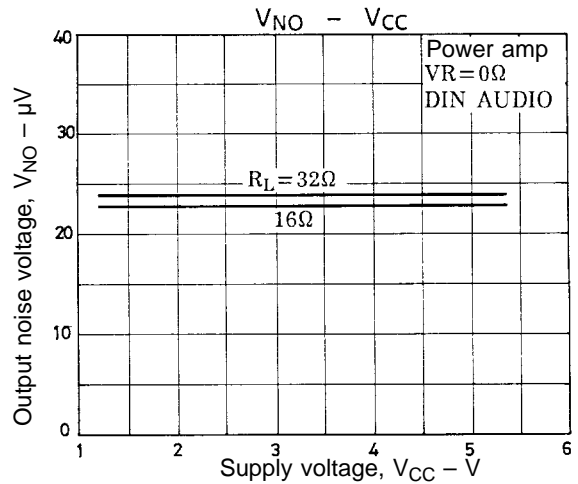
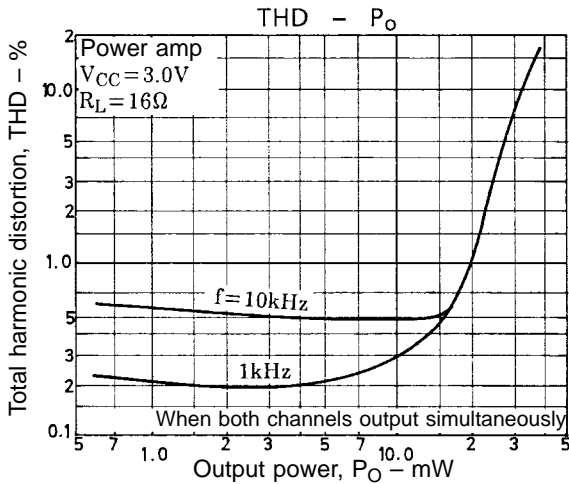
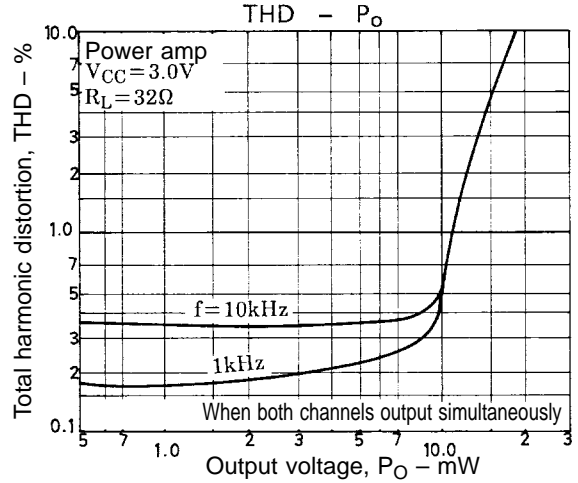
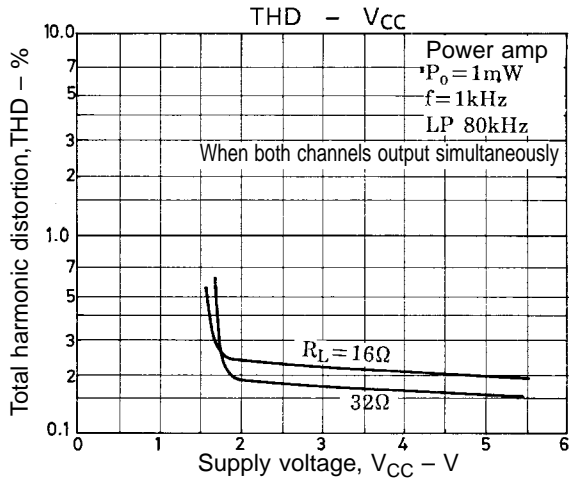

- Specifications of any and all SANYO products described or contained herein stipulate the performance, characteristics, and functions of the described products in the independent state, and are not guarantees of the performance, characteristics, and functions of the described products as mounted in the customer's products or equipment. To verify symptoms and states that cannot be evaluated in an independent device, the customer should always evaluate and test devices mounted in the customer's products or equipment.
- SANYO Electric Co., Ltd. strives to supply high-quality high-reliability products. However, any and all semiconductor products fail with some probability. It is possible that these probabilistic failures could give rise to accidents or events that could endanger human lives, that could give rise to smoke or fire, or that could cause damage to other property. When designing equipment, adopt safety measures so that these kinds of accidents or events cannot occur. Such measures include but are not limited to protective circuits and error prevention circuits for safe design, redundant design, and structural design.
- In the event that any or all SANYO products(including technical data, services) described or contained herein are controlled under any of applicable local export control laws and regulations, such products must not be exported without obtaining the export license from the authorities concerned in accordance with the above law.
- No part of this publication may be reproduced or transmitted in any form or by any means, electronic or mechanical, including photocopying and recording, or any information storage or retrieval system, or otherwise, without the prior written permission of SANYO Electric Co., Ltd.
- Any and all information described or contained herein are subject to change without notice due to product/technology improvement, etc. When designing equipment, refer to the "Delivery Specification" for the SANYO product that you intend to use.
- Information (including circuit diagrams and circuit parameters) herein is for example only ; it is not guaranteed for volume production. SANYO believes information herein is accurate and reliable, but no guarantees are made or implied regarding its use or any infringements of intellectual property rights or other rights of third parties.

This catalog provides information as of February, 1996. Specifications and information herein are subject to change without notice.