

High-Speed N-Channel Power MOSFET

Features:

- Low Drain-to-Source On Resistance ($R_{DS(ON)}$)
- Low Total Gate Charge (Q_G) and Gate-to-Drain Charge (Q_{GD})
- Low Series Gate Resistance (R_G)
- Fast Switching
- Capable of Short Dead-Time Operation
- RoHS Compliant

Description:

The MCP87018 is an N-Channel power MOSFET in a popular PDFN 5 mm x 6 mm package. Advanced packaging and silicon processing technologies allow the MCP87018 to achieve a low Q_G for a given $R_{DS(on)}$ value, resulting in a low Figure of Merit (FOM). Combined with low R_G , the low FOM of the MCP87018 allows high efficiency power conversion with reduced switching and conduction losses.

Applications:

- Point-of-Load DC-DC Converters
- High Efficiency Power Management in Servers, Networking and Automotive Applications

Package Type

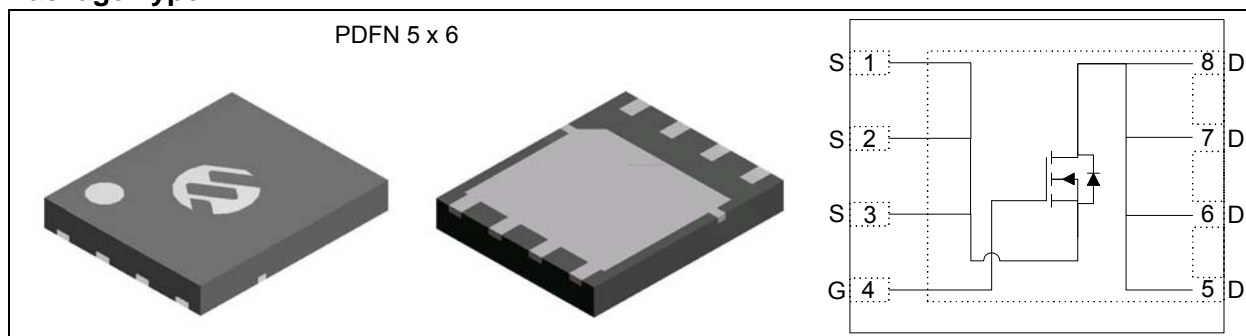

Product Summary Table: Unless otherwise indicated, $T_A = +25^\circ\text{C}$						
Parameters	Sym.	Min.	Typ.	Max.	Units	Conditions
Operating Characteristics						
Drain-to-Source Breakdown Voltage	BV_{DSS}	25	—	—	V	$V_{GS} = 0\text{V}$, $I_D = 250\ \mu\text{A}$
Gate-to-Source Threshold Voltage	$V_{GS(TH)}$	1	1.3	1.6	V	$V_{DS} = V_{GS}$, $I_D = 250\ \mu\text{A}$
Drain-to-Source On Resistance	$R_{DS(ON)}$	—	1.8	2.2	$\text{m}\Omega$	$V_{GS} = 4.5\text{V}$, $I_D = 25\text{A}$
		—	1.5	1.9	$\text{m}\Omega$	$V_{GS} = 10\text{V}$, $I_D = 25\text{A}$
Total Gate Charge	Q_G	—	32.5	37	nC	$V_{DS} = 12.5\text{V}$, $I_D = 25\text{A}$, $V_{GS} = 4.5\text{V}$
Gate-to-Drain Charge	Q_{GD}	—	13	—	nC	$V_{DS} = 12.5\text{V}$, $I_D = 25\text{A}$
Series Gate Resistance	R_G	—	1.5	—	Ω	—
Thermal Characteristics						
Thermal Resistance Junction-to-X	$R_{\theta JX}$	—	—	56	$^\circ\text{C}/\text{W}$	Note 1
Thermal Resistance Junction-to-Case	$R_{\theta JC}$	—	—	1.4	$^\circ\text{C}/\text{W}$	Note 2

- Note 1:** $R_{\theta JX}$ is determined with the device surface mounted on a 4-Layer FR4 PCB, with a 1" x 1" mounting pad of 2 oz. copper. This characteristic is dependent on user's board design.
- Note 2:** $R_{\theta JC}$ is determined using JEDEC 51-14 Method. This characteristic is determined by design.

MCP87018

1.0 ELECTRICAL CHARACTERISTICS

Absolute Maximum Ratings †

V_{DS}	+25V
V_{GS}	+10.0V / -8V
I_D , Continuous	100A, $T_C = +25^\circ\text{C}$
P_D	2.2W, $T_A = +25^\circ\text{C}$
T_J , T_{STG}	-55°C to +150°C
E_{AS} Avalanche Energy	612.5 mJ
$I_D = 35\text{A}$, $L = 1\text{ mH}$, $R_G = 25\Omega$	

† **Notice:** Stresses above those listed under “Maximum Ratings” may cause permanent damage to the device. This is a stress rating only and functional operation of the device at those or any other conditions above those indicated in the operational sections of this specification is not intended. Exposure to maximum rating conditions for extended periods may affect device reliability.

DC ELECTRICAL CHARACTERISTICS

Electrical Characteristics: Unless otherwise indicated, $T_A = +25^\circ\text{C}$						
Parameters	Sym.	Min.	Typ.	Max.	Units	Conditions
Static Characteristics						
Drain-to-Source Breakdown Voltage	B_{VDSS}	25	—	—	V	$V_{GS} = 0\text{V}$, $I_D = 250\ \mu\text{A}$
Drain-to-Source Leakage Current	I_{DSS}	—	—	1	μA	$V_{GS} = 0\text{V}$, $V_{DS} = 20\text{V}$
Gate-to-Source Leakage Current	I_{GSS}	—	—	100	nA	$V_{DS} = 0\text{V}$, $V_{GS} = 10\text{V}/-8\text{V}$
Gate-to-Source Threshold Voltage	$V_{GS(TH)}$	1	1.3	1.6	V	$V_{DS} = V_{GS}$, $I_D = 250\ \mu\text{A}$
Drain-to-Source On Resistance	$R_{DS(ON)}$	—	2.2	—		$V_{GS} = 3.3\text{V}$, $I_D = 25\ \text{A}$
		—	1.8	2.2	m Ω	$V_{GS} = 4.5\text{V}$, $I_D = 25\ \text{A}$
		—	1.5	1.9	m Ω	$V_{GS} = 10\text{V}$, $I_D = 25\ \text{A}$
Transconductance	g_{fs}	—	162	—	S	$V_{DS} = 12.5\text{V}$, $I_D = 25\text{A}$
Dynamic Characteristics						
Input Capacitance	C_{ISS}	—	2925	—	pF	$V_{GS} = 0\text{V}$, $V_{DS} = 12.5\text{V}$, $f = 1\ \text{MHz}$
Output Capacitance	C_{OSS}	—	1305	—	pF	$V_{GS} = 0\text{V}$, $V_{DS} = 12.5\text{V}$, $f = 1\ \text{MHz}$
Reverse Transfer Capacitance	C_{RSS}	—	330	—	pF	$V_{GS} = 0\text{V}$, $V_{DS} = 12.5\text{V}$, $f = 1\ \text{MHz}$
Total Gate Charge	Q_G	—	32.5	37	nC	$V_{DS} = 12.5\text{V}$, $I_D = 25\ \text{A}$, $V_{GS} = 4.5\text{V}$
Gate-to-Drain Charge	Q_{GD}	—	13	—	nC	$V_{DS} = 12.5\text{V}$, $I_D = 25\ \text{A}$
Gate-to-Source Charge	Q_{GS}	—	5.3	—	nC	$V_{DS} = 12.5\text{V}$, $I_D = 25\ \text{A}$
Gate Charge at $V_{GS(TH)}$	$Q_{G(TH)}$	—	3.8	—	nC	$V_{DS} = 12.5\text{V}$, $I_D = 25\ \text{A}$
Output Charge	Q_{OSS}	—	26	—	nC	$V_{DS} = 12.5\text{V}$, $V_{GS} = 0$
Turn-On Delay Time	$t_{d(on)}$	—	6.53	—	ns	$V_{DS} = 12.5\text{V}$, $V_{GS} = 4.5\text{V}$, $I_D = 25\text{A}$, $R_G = 2\Omega$
Rise Time	t_r	—	28.3	—	ns	$V_{DS} = 12.5\text{V}$, $V_{GS} = 4.5\text{V}$, $I_D = 25\text{A}$, $R_G = 2\Omega$
Turn-Off Delay Time	$t_{d(off)}$	—	26.35	—	ns	$V_{DS} = 12.5\text{V}$, $V_{GS} = 4.5\text{V}$, $I_D = 25\text{A}$, $R_G = 2\Omega$
Fall Time	t_f	—	28.05	—	ns	$V_{DS} = 12.5\text{V}$, $V_{GS} = 4.5\text{V}$, $I_D = 25\text{A}$, $R_G = 2\Omega$
Series Gate Resistance	R_G	—	1.5	—	Ω	

DC ELECTRICAL CHARACTERISTICS (CONTINUED)

Electrical Characteristics: Unless otherwise indicated, $T_A = +25^\circ\text{C}$						
Parameters	Sym.	Min.	Typ.	Max.	Units	Conditions
Diode Characteristics						
Diode Forward Voltage	V_{FD}	—	0.8	1	V	$I_S = 25\text{A}$, $V_{GS} = 0\text{V}$
Reverse Recovery Charge	Q_{RR}	—	47	—	nC	$I_S = 25\text{A}$, $di/dt = 300\text{ A}/\mu\text{s}$
Reverse Recovery Time	t_{rr}	—	28	—	ns	$I_S = 25\text{A}$, $di/dt = 300\text{ A}/\mu\text{s}$
Avalanche Characteristics						
Avalanche Energy	E_{AS}	200	—	—	mJ	$I_D = 20\text{A}$, $L = 1\text{ mH}$, $R_G = 25\Omega$

TEMPERATURE CHARACTERISTICS

Electrical Characteristics: Unless otherwise indicated, $T_A = +25^\circ\text{C}$						
Parameters	Sym.	Min.	Typ.	Max.	Units	Conditions
Temperature Ranges						
Operating Junction Temperature Range	T_J	-55	—	150	$^\circ\text{C}$	
Storage Temperature Range	T_A	-55	—	150	$^\circ\text{C}$	
Package Thermal Resistances						
Thermal Resistance Junction-to-X, 8L 5x6-PDFN	$R_{\theta JX}$	—	—	56	$^\circ\text{C}/\text{W}$	Note 1
Thermal Resistance Junction-to-Case, 8L 5x6-PDFN	$R_{\theta JC}$	—	—	1.4	$^\circ\text{C}/\text{W}$	Note 2

Note 1: $R_{\theta JX}$ is determined with the device surface mounted on a 4-Layer FR4 PCB, with a 1" x 1" mounting pad of 2 oz. copper. This characteristic is dependent on user's board design.

2: $R_{\theta JC}$ is determined using JEDEC 51-14 Method. This characteristic is determined by design.

MCP87018

2.0 TYPICAL PERFORMANCE CURVES

Note: The graphs and tables provided following this note are a statistical summary based on a limited number of samples and are provided for informational purposes only. The performance characteristics listed herein are not tested or guaranteed. In some graphs or tables, the data presented may be outside the specified operating range (e.g., outside specified power supply range) and therefore outside the warranted range.

Note: Unless otherwise indicated, $T_A = +25^\circ\text{C}$.

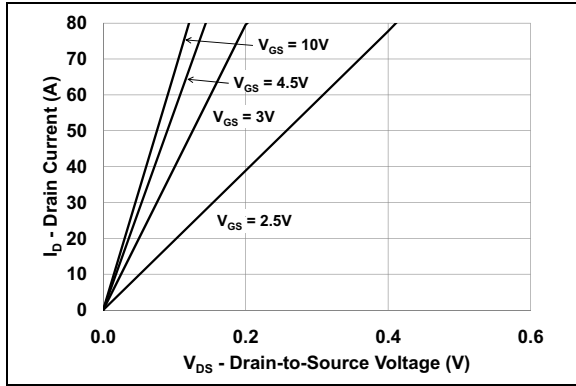

FIGURE 2-1: Typical Output Characteristics.

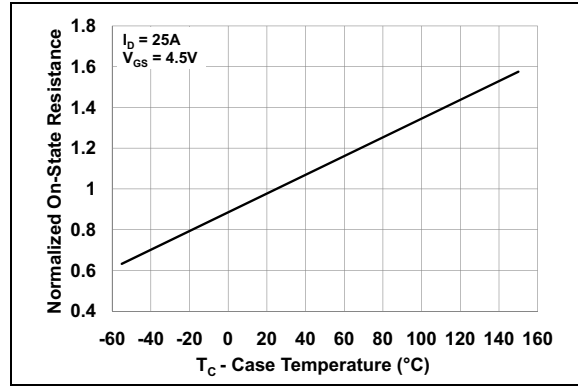

FIGURE 2-4: Normalized On Resistance vs. Temperature.

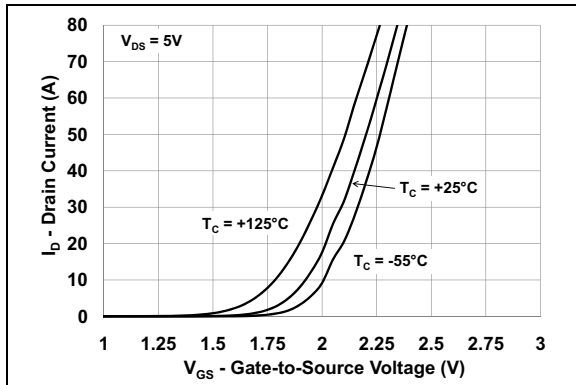

FIGURE 2-2: Typical Transfer Characteristics.

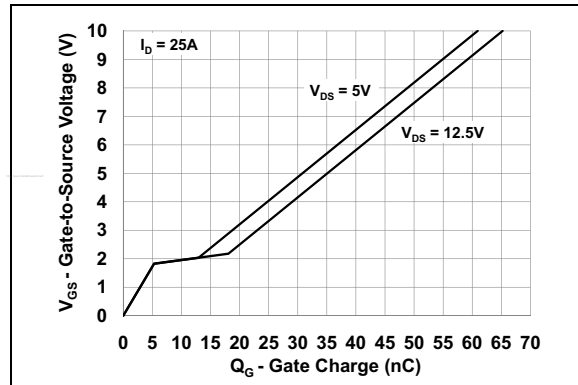

FIGURE 2-5: Gate-to-Source Voltage vs. Gate Charge.

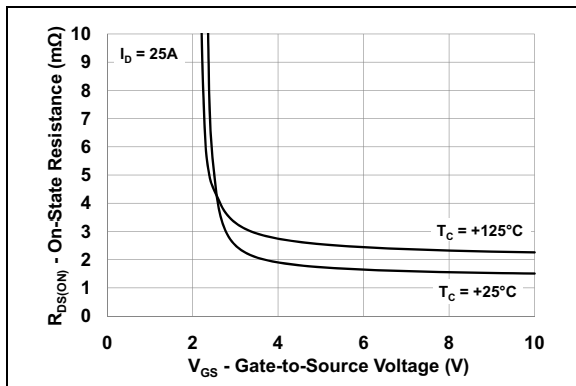

FIGURE 2-3: On Resistance vs. Gate-to-Source Voltage.

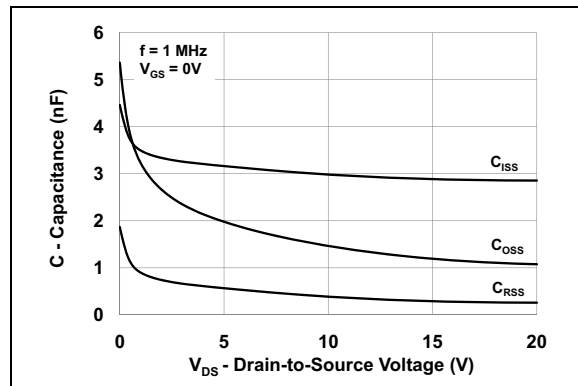

FIGURE 2-6: Capacitance vs. Drain-to-Source Voltage.

Note: Unless otherwise indicated, $T_A = +25^\circ\text{C}$.

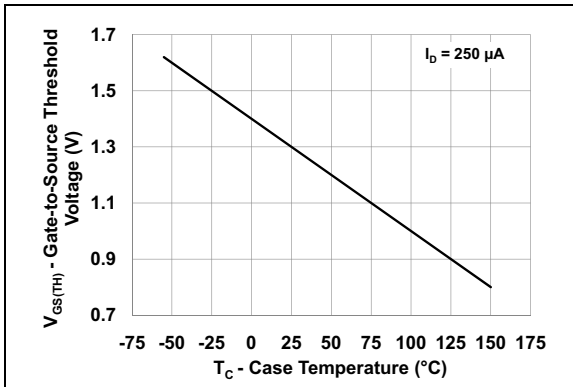

FIGURE 2-7: Gate-to-Source Threshold Voltage vs. Temperature.

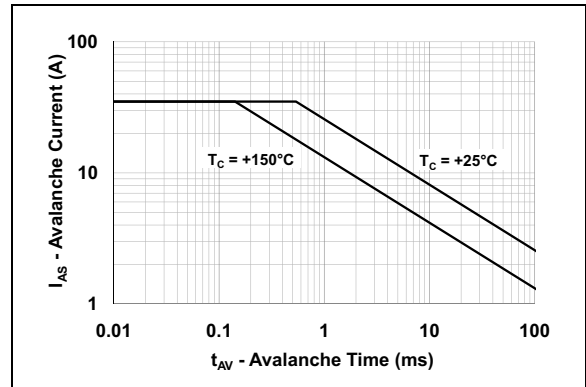

FIGURE 2-10: Single-Pulse Unclamped Inductive Switching.

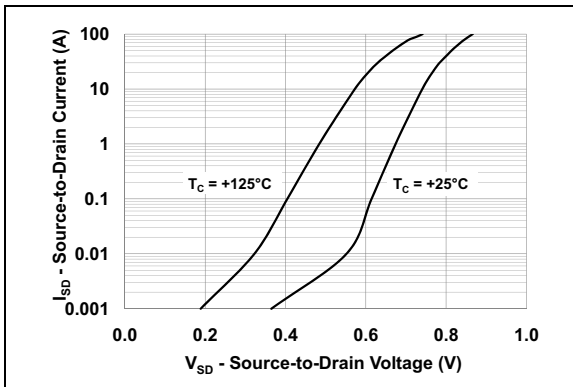

FIGURE 2-8: Source-to-Drain Current vs. Source-to-Drain Voltage.

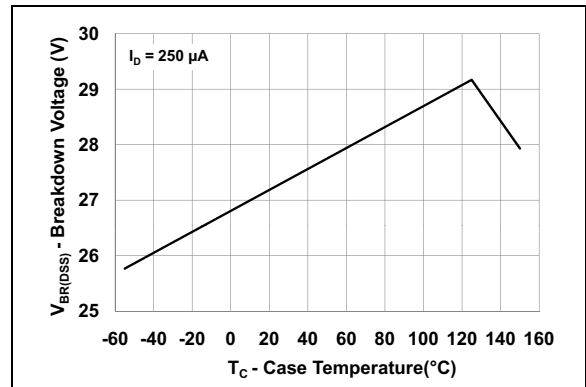

FIGURE 2-11: Drain-to-Source Breakdown Voltage vs. Temperature.

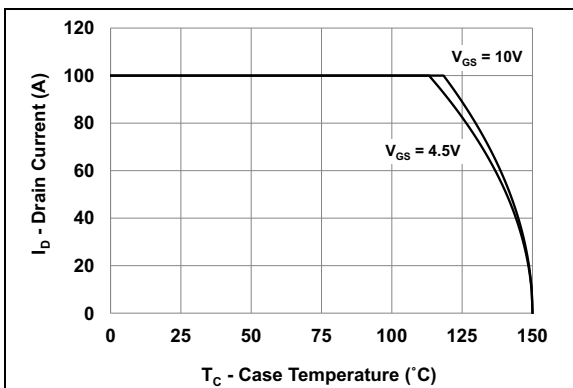

FIGURE 2-9: Maximum Drain Current vs. Temperature.

MCP87018

3.0 PIN DESCRIPTIONS

The descriptions of the pins are listed in [Table 3-1](#).

TABLE 3-1: PIN FUNCTION TABLE

MCP87018 5x6 PDFN	Symbol	Description
1, 2, 3	S	Source pin
4	G	Gate pin
5, 6, 7, 8	D	Drain pin, including exposed thermal pad

4.0 PACKAGING INFORMATION

4.1 Package Marking Information*

8-Lead PDFN (5x6x1.0 mm)

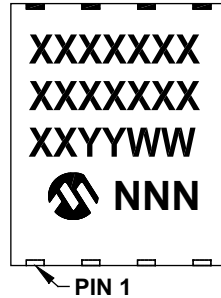

Example

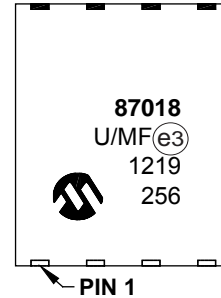

*RoHS compliant using EU-RoHS exemption: 7(a) – Lead in high-melting-temperature-type solders (i.e., lead-based alloys containing 85% by weight or more lead) can be found on the outer packaging for this package.

Legend:	XX...X	Customer-specific information
	Y	Year code (last digit of calendar year)
	YY	Year code (last 2 digits of calendar year)
	WW	Week code (week of January 1 is week '01')
	NNN	Alphanumeric traceability code
	(e3)	Pb-free JEDEC designator for Matte Tin (Sn)
	*	This package is Pb-free. The Pb-free JEDEC designator (e3) can be found on the outer packaging for this package.

Note: In the event the full Microchip part number cannot be marked on one line, it will be carried over to the next line, thus limiting the number of available characters for customer-specific information.

MCP87018

8-Lead Power Dual Flatpack No Lead Package (MF) – 5x6x1.0 mm Body [PDFN]

Note: For the most current package drawings, please see the Microchip Packaging Specification located at <http://www.microchip.com/packaging>

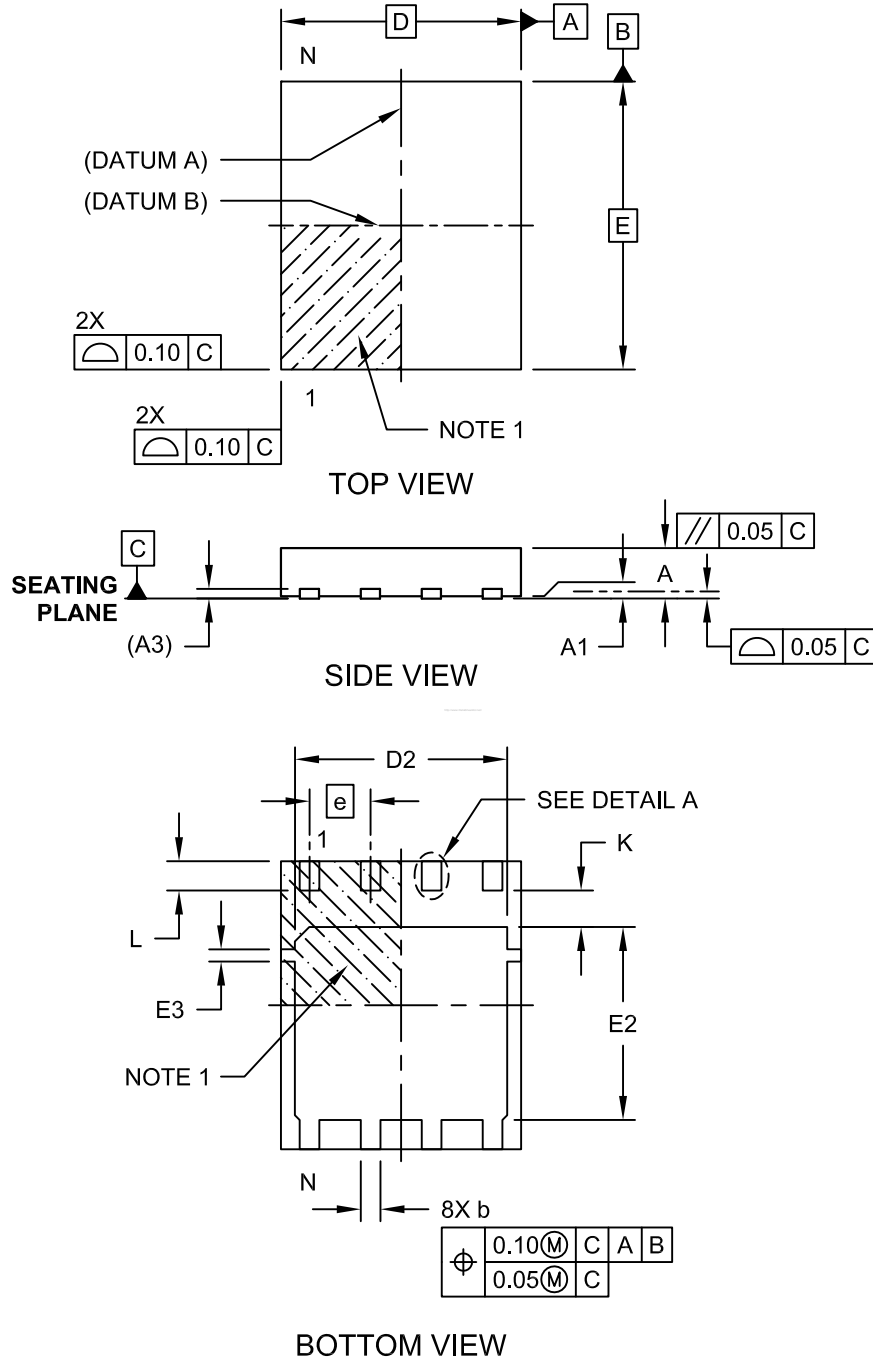

Microchip Technology Drawing C04-188B Sheet 1 of 2

8-Lead Power Dual Flatpack No Lead Package (MF) – 5x6x1.0 mm Body [PDFN]

Note: For the most current package drawings, please see the Microchip Packaging Specification located at <http://www.microchip.com/packaging>

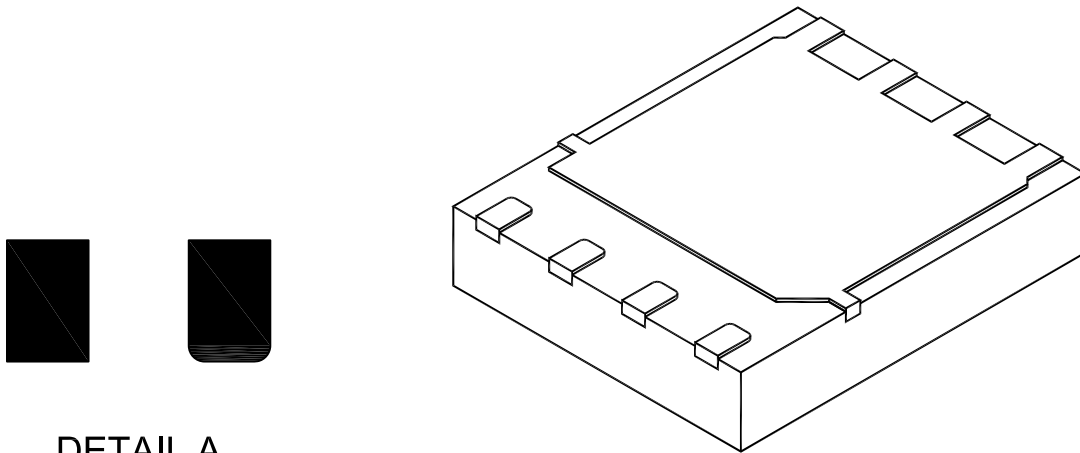

DETAIL A

ALTERNATE
CONTACT
SHAPES

Dimension	Units	MILLIMETERS		
	Limits	MIN	NOM	MAX
Number of Pins	N	8		
Pitch	e	1.27 BSC		
Overall Height	A	0.80	1.00	1.03
Standoff	A1	0.00	-	0.05
Terminal Thickness	(A3)	0.20 REF		
Overall Length	D	5.00 BSC		
Overall Width	E	6.00 BSC		
Exposed Pad length	D2	4.27	4.42	4.52
Exposed Pad Width	E2	3.87	4.02	4.12
Tab Width	E3	0.20	0.25	0.30
Terminal Width	b	0.36	0.41	0.46
Terminal Length	L	0.51	0.61	0.71
Terminal to Exposed Pad	K	0.71	0.76	0.81

Notes:

- Pin 1 visual index feature may vary, but must be located within the hatched area.
- Package is saw singulated.
- Package dimension does not include mold flash, protrusions, burrs or metal smearing.
- Dimensioning and tolerancing per ASME Y14.5M.
 - BSC: Basic Dimension. Theoretically exact value shown without tolerances.
 - REF: Reference Dimension, usually without tolerance, for information purposes only.

Microchip Technology Drawing C04-188B Sheet 2 of 2

MCP87018

8-Lead Power Dual Flatpack No Lead Package (MF) – 5x6x1.0 mm Body [PDFN]

Note: For the most current package drawings, please see the Microchip Packaging Specification located at <http://www.microchip.com/packaging>

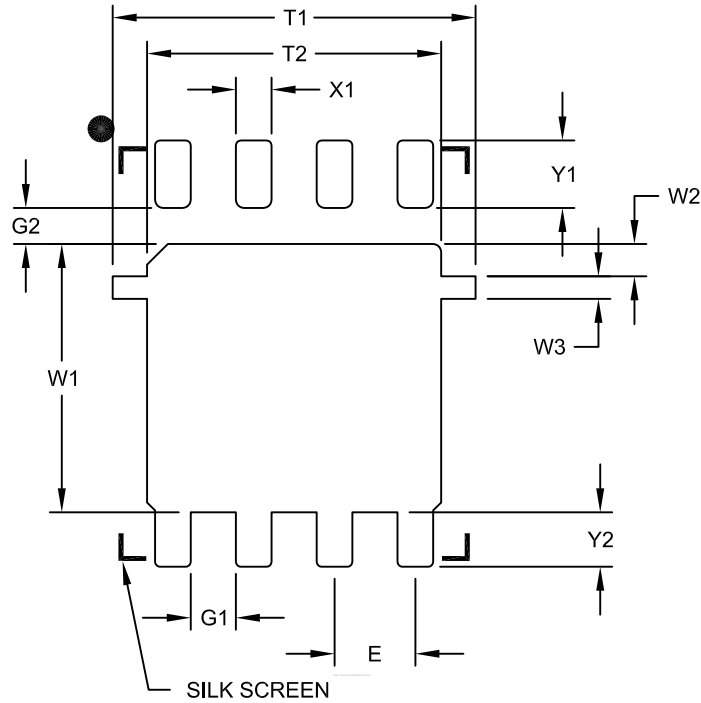

RECOMMENDED LAND PATTERN

Dimension Limits	Units	MILLIMETERS		
		MIN	NOM	MAX
Contact Pitch	E	1.27 BSC		
Center Pad Width	W1			4.22
Pad Edge to Tab	W2		0.51	
Tab Width	W3		0.35	
Center Pad Length With Tabs	T1			5.70
Center Pad Length	T2			4.62
Distance Between Terminals	G1	0.71		
Terminal To Center Pad (X4)	G2	0.57		
Terminal Pad Width (X8)	X1			0.56
Terminal Pad Length (X4)	Y1			1.06
Terminal Pad Length (X8)	Y2			0.86

Notes:

1. Dimensioning and tolerancing per ASME Y14.5M

BSC: Basic Dimension. Theoretically exact value shown without tolerances.

Microchip Technology Drawing No. C04-2188A

APPENDIX A: REVISION HISTORY

Revision A (January 2013)

- Original Release of this Document.

PRODUCT IDENTIFICATION SYSTEM

To order or obtain information, e.g., on pricing or delivery, refer to the factory or the listed sales office.

<u>PART NO.</u>	<u>X</u>	<u>/XX</u>
Device	Temperature Range	Package
Device:	MCP87018T:	N-Channel Power MOSFET (Tape and Reel)
Temperature Range:	U	= -55°C to +150°C (Ultra High)
Package:	MF	= 8-Lead High Power Dual Flatpack, No Lead Package (5x6x1.0 mm Body) (PDFN), 8-lead

Examples:

a) MCP87018T-U/MF: Tape and Reel, Ultra High Temperature, 8LD PDFN package

Note the following details of the code protection feature on Microchip devices:

- Microchip products meet the specification contained in their particular Microchip Data Sheet.
- Microchip believes that its family of products is one of the most secure families of its kind on the market today, when used in the intended manner and under normal conditions.
- There are dishonest and possibly illegal methods used to breach the code protection feature. All of these methods, to our knowledge, require using the Microchip products in a manner outside the operating specifications contained in Microchip's Data Sheets. Most likely, the person doing so is engaged in theft of intellectual property.
- Microchip is willing to work with the customer who is concerned about the integrity of their code.
- Neither Microchip nor any other semiconductor manufacturer can guarantee the security of their code. Code protection does not mean that we are guaranteeing the product as “unbreakable.”

Code protection is constantly evolving. We at Microchip are committed to continuously improving the code protection features of our products. Attempts to break Microchip's code protection feature may be a violation of the Digital Millennium Copyright Act. If such acts allow unauthorized access to your software or other copyrighted work, you may have a right to sue for relief under that Act.

Information contained in this publication regarding device applications and the like is provided only for your convenience and may be superseded by updates. It is your responsibility to ensure that your application meets with your specifications. MICROCHIP MAKES NO REPRESENTATIONS OR WARRANTIES OF ANY KIND WHETHER EXPRESS OR IMPLIED, WRITTEN OR ORAL, STATUTORY OR OTHERWISE, RELATED TO THE INFORMATION, INCLUDING BUT NOT LIMITED TO ITS CONDITION, QUALITY, PERFORMANCE, MERCHANTABILITY OR FITNESS FOR PURPOSE. Microchip disclaims all liability arising from this information and its use. Use of Microchip devices in life support and/or safety applications is entirely at the buyer's risk, and the buyer agrees to defend, indemnify and hold harmless Microchip from any and all damages, claims, suits, or expenses resulting from such use. No licenses are conveyed, implicitly or otherwise, under any Microchip intellectual property rights.

Trademarks

The Microchip name and logo, the Microchip logo, dsPIC, FlashFlex, KEELOQ, KEELOQ logo, MPLAB, PIC, PICmicro, PICSTART, PIC³² logo, rPIC, SST, SST Logo, SuperFlash and UNI/O are registered trademarks of Microchip Technology Incorporated in the U.S.A. and other countries.

FilterLab, Hampshire, HI-TECH C, Linear Active Thermistor, MTP, SEEVAL and The Embedded Control Solutions Company are registered trademarks of Microchip Technology Incorporated in the U.S.A.

Silicon Storage Technology is a registered trademark of Microchip Technology Inc. in other countries.

Analog-for-the-Digital Age, Application Maestro, BodyCom, chipKIT, chipKIT logo, CodeGuard, dsPICDEM, dsPICDEM.net, dsPICworks, dsSPEAK, ECAN, ECONOMONITOR, FanSense, HI-TIDE, In-Circuit Serial Programming, ICSP, Mindi, MiWi, MPASM, MPF, MPLAB Certified logo, MPLIB, MPLINK, mTouch, Omniclient Code Generation, PICC, PICC-18, PICDEM, PICDEM.net, PICkit, PICTail, REAL ICE, rFLAB, Select Mode, SQI, Serial Quad I/O, Total Endurance, TSHARC, UniWinDriver, WiperLock, ZENA and Z-Scale are trademarks of Microchip Technology Incorporated in the U.S.A. and other countries.

SQTP is a service mark of Microchip Technology Incorporated in the U.S.A.

GestIC and ULPP are registered trademarks of Microchip Technology Germany II GmbH & Co. & KG, a subsidiary of Microchip Technology Inc., in other countries.

All other trademarks mentioned herein are property of their respective companies.

© 2013, Microchip Technology Incorporated, Printed in the U.S.A., All Rights Reserved.

 Printed on recycled paper.

ISBN: 978-1-62076-955-3

Microchip received ISO/TS-16949:2009 certification for its worldwide headquarters, design and wafer fabrication facilities in Chandler and Tempe, Arizona; Gresham, Oregon and design centers in California and India. The Company's quality system processes and procedures are for its PIC[®] MCUs and dsPIC[®] DSCs, KEELOQ[®] code hopping devices, Serial EEPROMs, microperipherals, nonvolatile memory and analog products. In addition, Microchip's quality system for the design and manufacture of development systems is ISO 9001:2000 certified.

QUALITY MANAGEMENT SYSTEM
CERTIFIED BY DNV
== ISO/TS 16949 ==



MICROCHIP

Worldwide Sales and Service

AMERICAS

Corporate Office
2355 West Chandler Blvd.
Chandler, AZ 85224-6199
Tel: 480-792-7200
Fax: 480-792-7277
Technical Support:
<http://www.microchip.com/support>
Web Address:
www.microchip.com

Atlanta
Duluth, GA
Tel: 678-957-9614
Fax: 678-957-1455

Boston
Westborough, MA
Tel: 774-760-0087
Fax: 774-760-0088

Chicago
Itasca, IL
Tel: 630-285-0071
Fax: 630-285-0075

Cleveland
Independence, OH
Tel: 216-447-0464
Fax: 216-447-0643

Dallas
Addison, TX
Tel: 972-818-7423
Fax: 972-818-2924

Detroit
Farmington Hills, MI
Tel: 248-538-2250
Fax: 248-538-2260

Indianapolis
Noblesville, IN
Tel: 317-773-8323
Fax: 317-773-5453

Los Angeles
Mission Viejo, CA
Tel: 949-462-9523
Fax: 949-462-9608

Santa Clara
Santa Clara, CA
Tel: 408-961-6444
Fax: 408-961-6445

Toronto
Mississauga, Ontario,
Canada
Tel: 905-673-0699
Fax: 905-673-6509

ASIA/PACIFIC

Asia Pacific Office
Suites 3707-14, 37th Floor
Tower 6, The Gateway
Harbour City, Kowloon
Hong Kong
Tel: 852-2401-1200
Fax: 852-2401-3431

Australia - Sydney
Tel: 61-2-9868-6733
Fax: 61-2-9868-6755

China - Beijing
Tel: 86-10-8569-7000
Fax: 86-10-8528-2104

China - Chengdu
Tel: 86-28-8665-5511
Fax: 86-28-8665-7889

China - Chongqing
Tel: 86-23-8980-9588
Fax: 86-23-8980-9500

China - Hangzhou
Tel: 86-571-2819-3187
Fax: 86-571-2819-3189

China - Hong Kong SAR
Tel: 852-2943-5100
Fax: 852-2401-3431

China - Nanjing
Tel: 86-25-8473-2460
Fax: 86-25-8473-2470

China - Qingdao
Tel: 86-532-8502-7355
Fax: 86-532-8502-7205

China - Shanghai
Tel: 86-21-5407-5533
Fax: 86-21-5407-5066

China - Shenyang
Tel: 86-24-2334-2829
Fax: 86-24-2334-2393

China - Shenzhen
Tel: 86-755-8864-2200
Fax: 86-755-8203-1760

China - Wuhan
Tel: 86-27-5980-5300
Fax: 86-27-5980-5118

China - Xian
Tel: 86-29-8833-7252
Fax: 86-29-8833-7256

China - Xiamen
Tel: 86-592-2388138
Fax: 86-592-2388130

China - Zhuhai
Tel: 86-756-3210040
Fax: 86-756-3210049

ASIA/PACIFIC

India - Bangalore
Tel: 91-80-3090-4444
Fax: 91-80-3090-4123

India - New Delhi
Tel: 91-11-4160-8631
Fax: 91-11-4160-8632

India - Pune
Tel: 91-20-2566-1512
Fax: 91-20-2566-1513

Japan - Osaka
Tel: 81-6-6152-7160
Fax: 81-6-6152-9310

Japan - Tokyo
Tel: 81-3-6880-3770
Fax: 81-3-6880-3771

Korea - Daegu
Tel: 82-53-744-4301
Fax: 82-53-744-4302

Korea - Seoul
Tel: 82-2-554-7200
Fax: 82-2-558-5932 or
82-2-558-5934

Malaysia - Kuala Lumpur
Tel: 60-3-6201-9857
Fax: 60-3-6201-9859

Malaysia - Penang
Tel: 60-4-227-8870
Fax: 60-4-227-4068

Philippines - Manila
Tel: 63-2-634-9065
Fax: 63-2-634-9069

Singapore
Tel: 65-6334-8870
Fax: 65-6334-8850

Taiwan - Hsin Chu
Tel: 886-3-5778-366
Fax: 886-3-5770-955

Taiwan - Kaohsiung
Tel: 886-7-213-7828
Fax: 886-7-330-9305

Taiwan - Taipei
Tel: 886-2-2508-8600
Fax: 886-2-2508-0102

Thailand - Bangkok
Tel: 66-2-694-1351
Fax: 66-2-694-1350

EUROPE

Austria - Wels
Tel: 43-7242-2244-39
Fax: 43-7242-2244-393

Denmark - Copenhagen
Tel: 45-4450-2828
Fax: 45-4485-2829

France - Paris
Tel: 33-1-69-53-63-20
Fax: 33-1-69-30-90-79

Germany - Munich
Tel: 49-89-627-144-0
Fax: 49-89-627-144-44

Italy - Milan
Tel: 39-0331-742611
Fax: 39-0331-466781

Netherlands - Drunen
Tel: 31-416-690399
Fax: 31-416-690340

Spain - Madrid
Tel: 34-91-708-08-90
Fax: 34-91-708-08-91

UK - Wokingham
Tel: 44-118-921-5869
Fax: 44-118-921-5820

11/29/12