

W24L010A



128K × 8 HIGH SPEED CMOS STATIC RAM

GENERAL DESCRIPTION

The W24L010A is a high speed, low power CMOS static RAM organized as 131072 × 8 bits that operates on a single 3.3-volt power supply. This device is manufactured using Winbond's high performance CMOS technology.

FEATURES

- High speed access time: 10/12/15 nS (max.)
- Low power consumption:
 - Active: 300 mW (typ.)
- Single +3.3V power supply
- Fully static operation
- All inputs and outputs directly TTL/LVTTL compatible
- Three-state outputs
- Available packages: 32-pin 300 mil SOJ, skinny DIP and TSOP

PIN CONFIGURATIONS

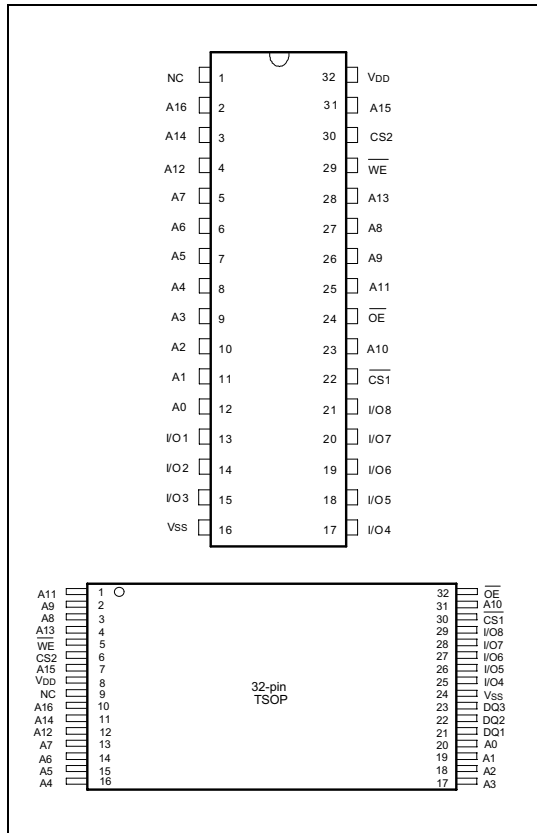

BLOCK DIAGRAM

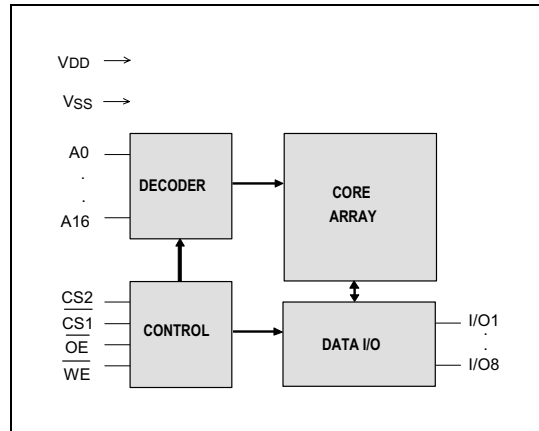

PIN DESCRIPTION

SYMBOL	DESCRIPTION
A0–A16	Address Inputs
I/O1–I/O8	Data Inputs/Outputs
CS1, CS2	Chip Select Inputs
WE	Write Enable Input
OE	Output Enable Input
VDD	Power Supply
VSS	Ground
NC	No Connection



DC CHARACTERISTICS

Absolute Maximum Ratings

PARAMETER	RATING	UNIT
Supply Voltage to VSS Potential	-0.5 to +4.6	V
Input/Output to VSS Potential	-0.5 to VDD +0.5	V
Allowable Power Dissipation	1.0	W
Storage Temperature	-65 to +150	°C
Operating Temperature	0 to +70	°C

Note: Exposure to conditions beyond those listed under Absolute Maximum Ratings may adversely affect the life and reliability of the device.

TRUTH TABLE

CS1	CS2	OE	WE	MODE	I/O1–I/O8	VDD CURRENT
H	X	X	X	Not Selected	High Z	ISB, ISB1
X	L	X	X	Not Selected	High Z	ISB, ISB1
L	H	H	H	Output Disable	High Z	IDD
L	H	L	H	Read	Data Out	IDD
L	H	X	L	Write	Data In	IDD

OPERATING CHARACTERISTICS

(VDD = 3.3V ±5%, VSS = 0V, TA = 0 to 70° C)

PARAMETER	SYM.	TEST CONDITIONS	MIN.	TYP.	MAX.	UNIT	
Input Low Voltage	VIL	-	-0.5	-	+0.8	V	
Input High Voltage	VIH	-	+2.0	-	VDD +0.5	V	
Input Leakage Current	ILI	VIN = VSS to VDD	-10	-	+10	µA	
Output Leakage Current	ILO	V _{I/O} = VSS to VDD CS1 = VIH or CS2 = VIL or OE = VIH or WE = VIL	-10	-	+10	µA	
Output Low Voltage	VOL	IOL = +8.0 mA	-	-	0.4	V	
Output High Voltage	VOH	IOH = -4.0 mA	2.4	-	-	V	
Operating Power Supply Current	IDD	CS1 = VIL, CS2 = VIH I/O = 0 mA Cycle = MIN Duty = 100%	10	-	-	130	mA
			12	-	-	120	mA
			15	-	-	100	mA
Standby Power Supply Current	ISB	CS1 = VIH, or CS2 = VIL	-	-	15	mA	
	ISB1	CS1 ≥ VDD -0.2V or CS2 ≤ 0.2V	-	-	5	mA	

Note: Typical characteristics are at VDD = 3.3V, TA = 25° C.



CAPACITANCE

($V_{DD} = 3.3V$, $T_A = 25^\circ C$, $f = 1 MHz$)

PARAMETER	SYM.	CONDITIONS	MAX.	UNIT
Input Capacitance	C _{IN}	V _{IN} = 0V	8	pF
Input/Output Capacitance	C _{I/O}	V _{OUT} = 0V	10	pF

Note: These parameters are sampled but not 100% tested.

AC TEST CONDITIONS

PARAMETER	CONDITIONS
Input Pulse Levels	0V to 3V
Input Rise and Fall Times	3 nS
Input and Output Timing Reference Level	1.5V
Output Load	CL = 30 pF, I _{OH} /I _{OL} = -4 mA/8 mA

AC TEST LOADS AND WAVEFORM

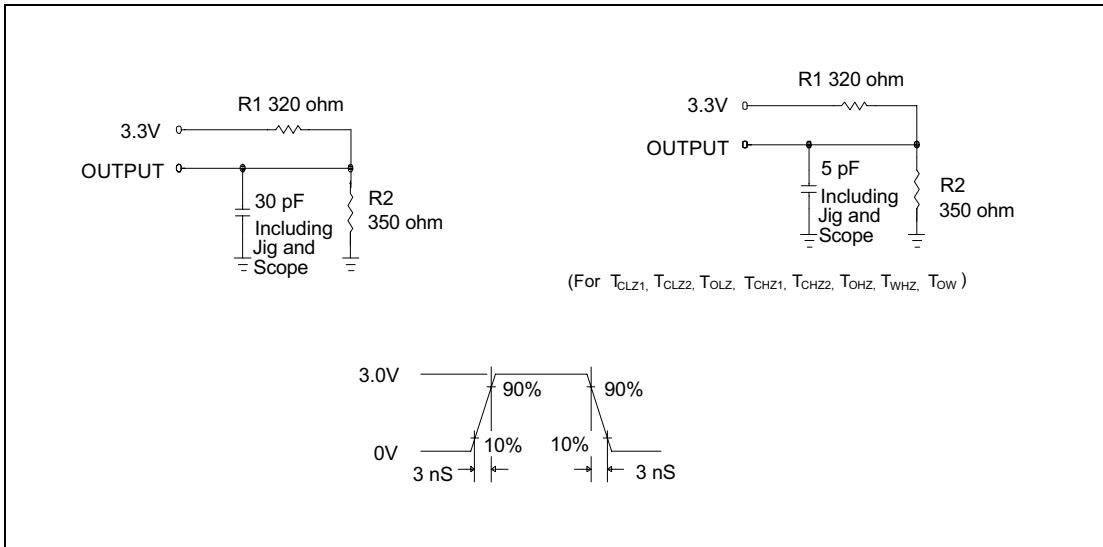

W24L010A



AC CHARACTERISTICS

(V_{DD} = 3.3V ±5%, V_{SS} = 0V, T_A = 0 to 70° C)

Read Cycle

PARAMETER	SYM.	W24L010A-10		W24L010A-12		W24L010A-15		UNIT	
		MIN.	MAX.	MIN.	MAX.	MIN.	MAX.		
Read Cycle Time	T _{RC}	10	-	12	-	15	-	nS	
Address Access Time	T _{AA}	-	10	-	12	-	15	nS	
Chip Select Access Time	$\overline{\text{CS}}1$	T _{ACS1}	-	10	-	12	-	15	nS
	CS2	T _{ACS2}	-	10	-	12	-	15	nS
Output Enable to Output Valid	T _{AOE}	-	5	-	6	-	7	nS	
Chip Selection to Output in Low Z	$\overline{\text{CS}}1$	T _{CLZ1*}	3	-	3	-	3	-	nS
Low Z	CS2	T _{CLZ2*}	3	-	3	-	3	-	nS
Output Enable to Output in Low Z	T _{OLZ*}	0	-	0	-	0	-	nS	
Chip Deselection to Output in High Z	$\overline{\text{CS}}1$	T _{CHZ1*}	-	5	-	6	-	7	nS
High Z	CS2	T _{CHZ2*}	-	5	-	6	-	7	nS
Output Disable to Output in High Z	T _{OHZ*}	-	5	-	6	-	7	nS	
Output Hold from Address Change	T _{OH}	3	-	3	-	3	-	nS	

* These parameters are sampled but not 100% tested.

Write Cycle

PARAMETER	SYM.	W24L010A-10		W24L010A-12		W24L010A-15		UNIT	
		MIN.	MAX.	MIN.	MAX.	MIN.	MAX.		
Write Cycle Time	T _{WC}	10	-	12	-	15	-	nS	
Chip Selection to End of Write	$\overline{\text{CS}}1$	T _{CW1}	9	-	10	-	13	nS	
	CS2	T _{CW2}	9	-	10	-	13	nS	
Address Valid to End of Write	T _{AW}	9	-	10	-	13	-	nS	
Address Setup Time	T _{AS}	0	-	0	-	0	-	nS	
Write Pulse Width	T _{WP}	9	-	10	-	10	-	nS	
Write Recovery Time	$\overline{\text{CS}}1, \overline{\text{WE}}$	T _{WR1}	0	-	0	-	0	-	nS
	CS2	T _{WR2}	0	-	0	-	0	-	nS
Data Valid to End of Write	T _{DW}	5	-	7	-	9	-	nS	
Data Hold from End of Write	T _{DH}	0	-	0	-	0	-	nS	
Write to Output in High Z	T _{WHZ*}	-	5	-	6	-	8	nS	
Output Disable to Output in High Z	T _{OHZ*}	-	5	-	6	-	8	nS	
Output Active from End of Write	T _{OW}	0	-	0	-	0	-	nS	

* These parameters are sampled but not 100% tested.



TIMING WAVEFORMS

Read Cycle 1

(Address Controlled)

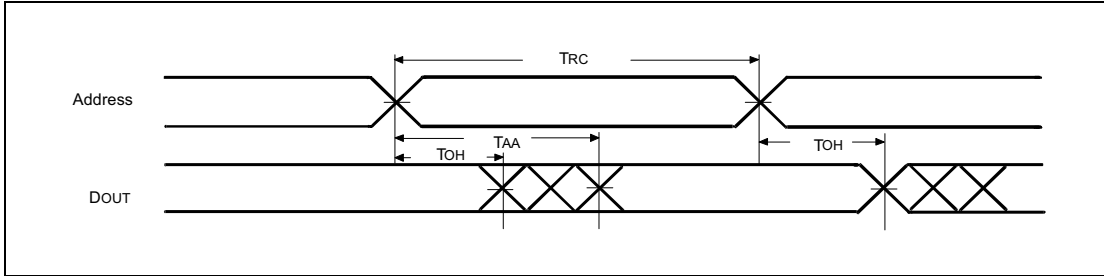

Read Cycle 2

(Chip Select Controlled)

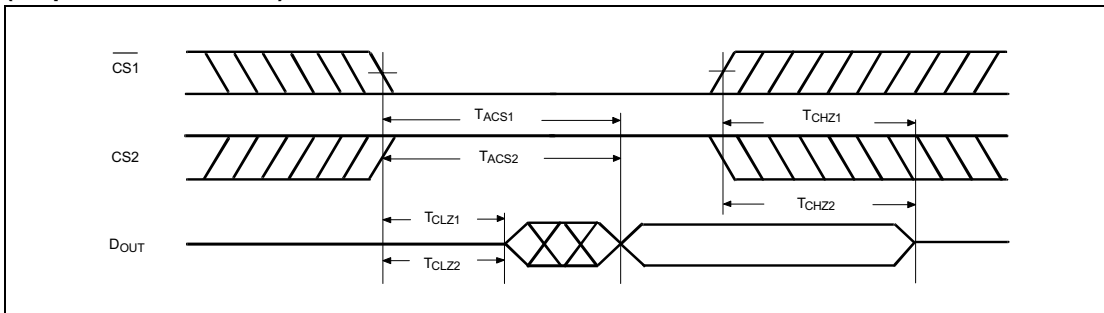

Read Cycle 3

(Output Enable Controlled)

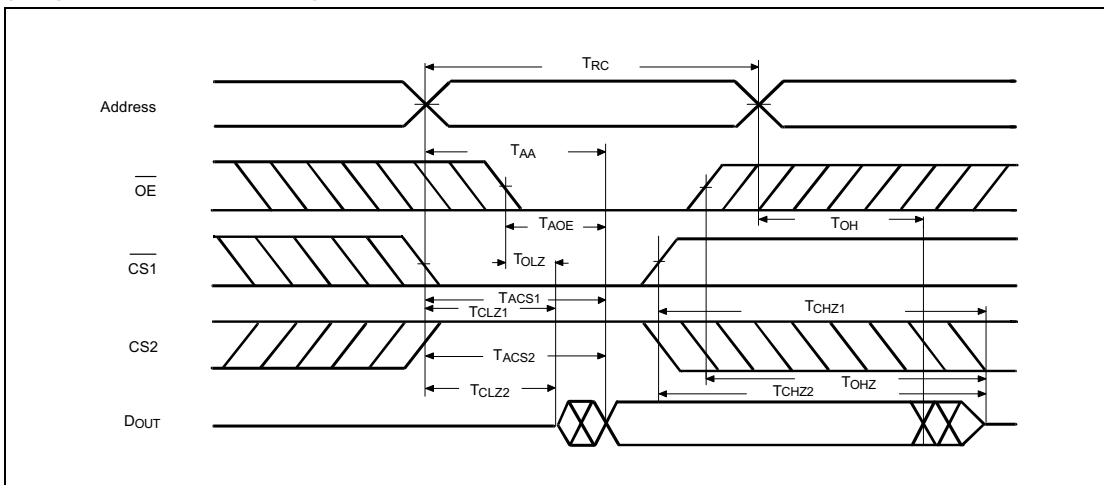



Timing Waveforms, continued

Write Cycle 1

($\overline{\text{OE}}$ Clock)

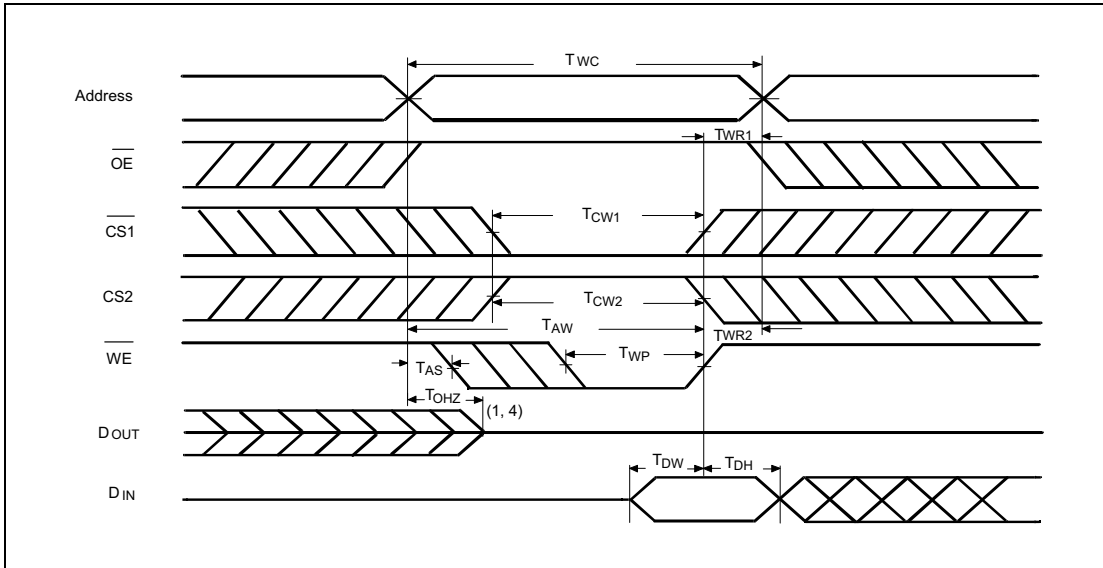

Write Cycle 2

($\overline{\text{OE}} = V_{IL}$ Fixed)

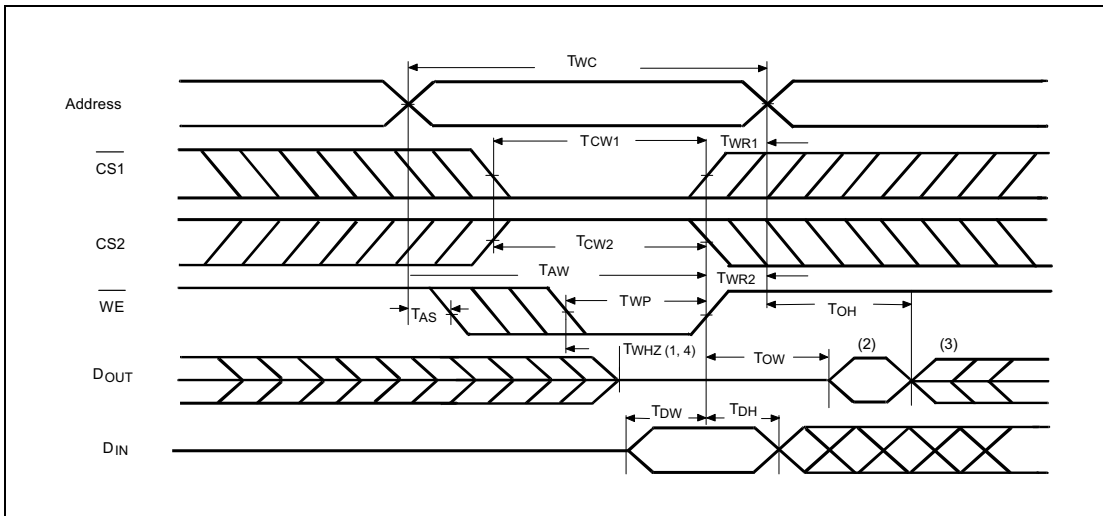

Notes:

1. During this period, I/O pins are in the output state, so input signals of opposite phase to the outputs should not be applied.
2. The data output from DOUT are the same as the data written to DIN during the write cycle.
3. DOUT provides the read data for the next address.
4. Transition is measured ± 500 mV from steady state with $C_L = 5$ pF. This parameter is guaranteed but not 100% tested.

W24L010A



ORDERING INFORMATION

PART NO.	ACCESS TIME (nS)	OPERATING CURRENT MAX. (mA)	STANDBY CURRENT MAX. (mA)	PACKAGE
W24L010AK-10	10	130	5	300 mil skinny DIP
W24L010AK-12	12	120	5	300 mil skinny DIP
W24L010AK-15	15	100	5	300 mil skinny DIP
W24L010AJ-10	10	130	5	300 mil SOJ
W24L010AJ-12	12	120	5	300 mil SOJ
W24L010AJ-15	15	100	5	300 mil SOJ
W24L010AT-10	10	130	5	Type one TSOP
W24L010AT-12	12	120	5	Type one TSOP
W24L010AT-15	15	100	5	Type one TSOP

Notes:

1. Winbond reserves the right to make changes to its products without prior notice.
2. Purchasers are responsible for performing appropriate quality assurance testing on products intended for use in applications where personal injury might occur as a consequence of product failure.

PACKAGE DIMENSIONS

32-pin SOJ

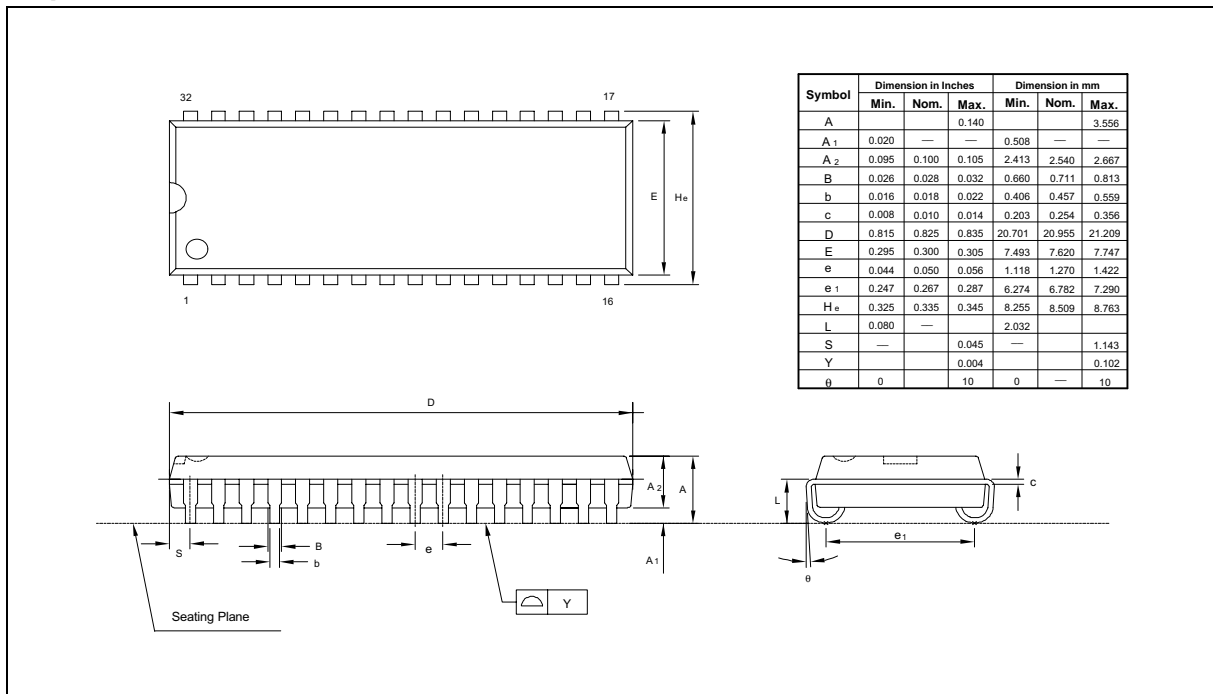

W24L010A



Package Dimensions, continued

32-pin TSOP

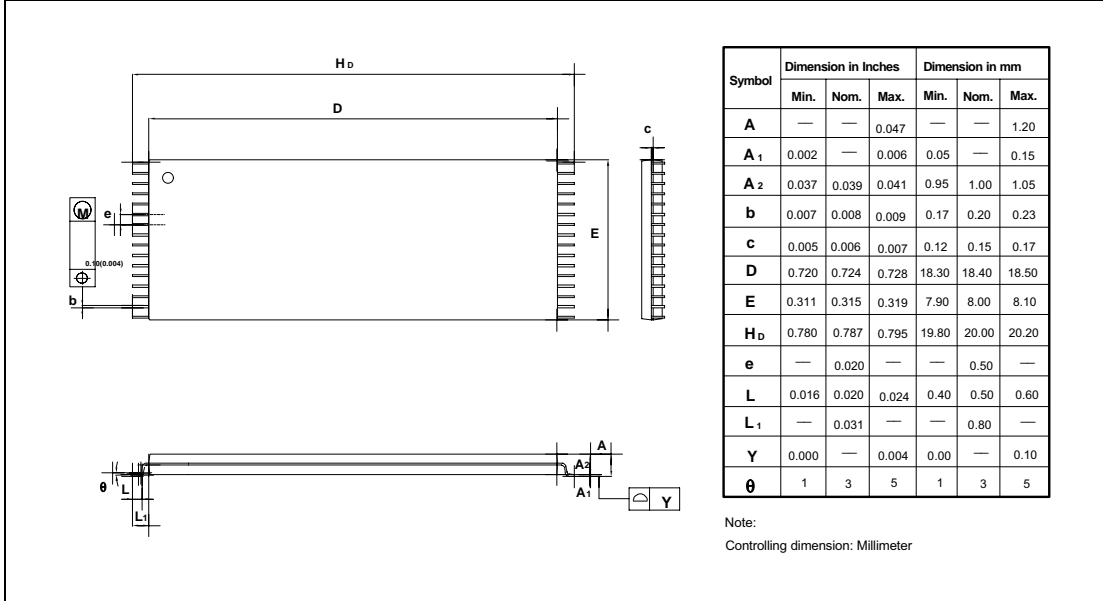

Headquarters

No. 4, Creation Rd. III,
Science-Based Industrial Park,
Hsinchu, Taiwan
TEL: 886-3-5770066
FAX: 886-3-5792647
<http://www.winbond.com.tw/>
Voice & Fax-on-demand: 886-2-7197006

Taipei Office

11F, No. 115, Sec. 3, Min-Sheng East Rd.,
Taipei, Taiwan
TEL: 886-2-7190505
FAX: 886-2-7197502

Winbond Electronics (H.K.) Ltd.

Rm. 803, World Trade Square, Tower II,
123 Hoi Bun Rd., Kwun Tong,
Kowloon, Hong Kong
TEL: 852-27513100
FAX: 852-27552064

Winbond Electronics North America Corp.

Winbond Memory Lab.
Winbond Microelectronics Corp.
Winbond Systems Lab.
2730 Orchard Parkway, San Jose,
CA 95134, U.S.A.
TEL: 1-408-9436666
FAX: 1-408-9436668

Note: All data and specifications are subject to change without notice.