

GSD965

NPN EPITAXIAL PLANAR TRANSISTOR

Description

The GSD965 is designed for use as AF output amplifier and flash unit

Package Dimensions

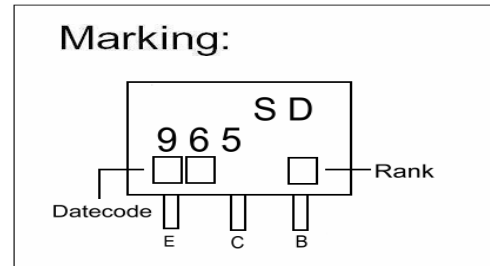
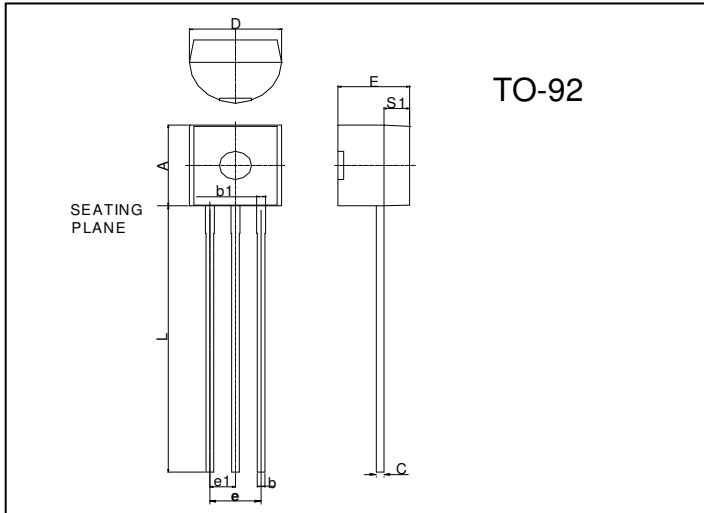

REF.	Millimeter		REF.	Millimeter	
	Min.	Max.		Min.	Max.
A	4.45	4.7	D	4.44	4.7
S1	1.02	-	E	3.30	3.81
b	0.36	0.51	L	12.70	-
b1	0.36	0.76	e1	1.150	1.390
C	0.36	0.51	e	2.42	2.66

Absolute Maximum Ratings at Ta = 25°C

Collector to Base Voltage	BVCBO	40	V
Collector to Emitter Voltage	BVCEO	20	V
Emitter to Base Voltage	BVEBO	7.0	V
Collector Current (Continuous)	IC	5	A
Collector Current (Peak PT=10mS)	IC	8	A
Junction Temperature	Tj	+150	°C
Storage Temperature	Tstg	-55 ~ +150	°C
Total Power Dissipation at Ta = 25°C	PD	0.75	W

Characteristics at Ta = 25°C

Symbol	Min.	Typ.	Max.	Unit	Test Conditions
BVCBO	40	-	-	V	IC=100uA
BVCEO	20	-	-	V	IC=1mA
BVEBO	7	-	-	V	IE=10uA
ICBO	-	-	0.1	uA	VCB=60V
IEBO	-	-	0.1	uA	VEB=7V
*VCE(sat)	-	0.35	1	V	IC=3A, IB=0.1A
*hFE1	230	-	800		VCE=2V, IC=0.5A
*hFE2	150	-	-		VCE=2V, IC=2A
fT	-	150	-	MHz	VCE=6V, IE=50mA
Cob	-	-	50	pF	VCB=20V, f=1MHz

* Pulse Test: Pulse Width ≤ 380us, Duty Cycle ≤ 2%

Classification Of hFE1

Rank	Q	R	S
Range	230-380	340-600	560-800

Characteristics Curve

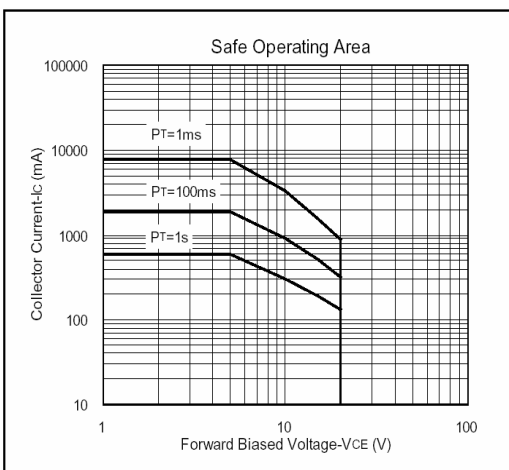
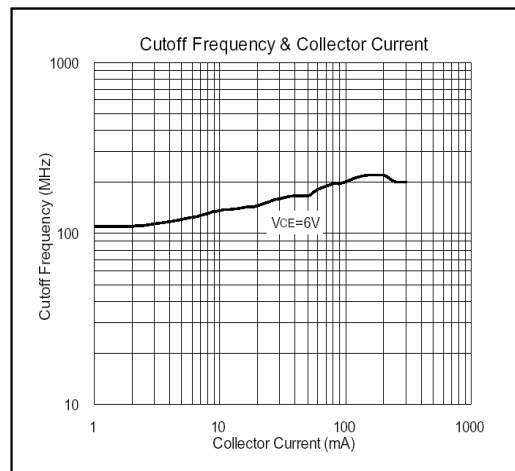
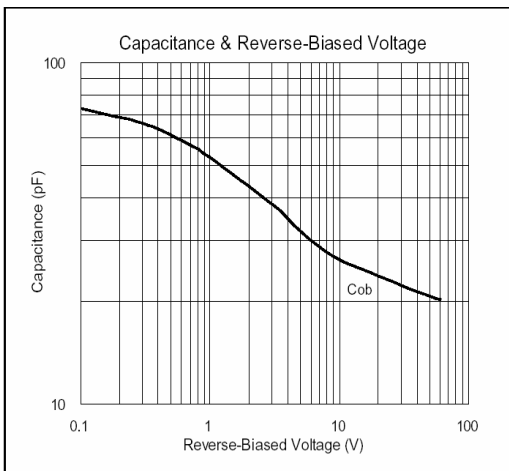
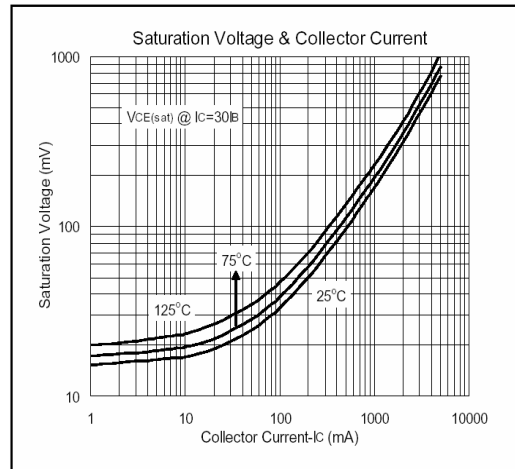
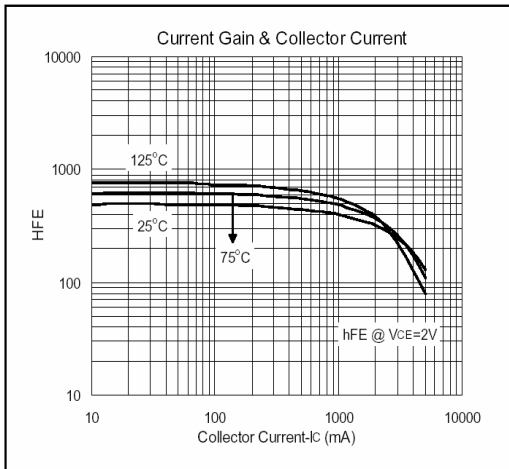

Important Notice:

- All rights are reserved. Reproduction in whole or in part is prohibited without the prior written approval of GTM.
- GTM reserves the right to make changes to its products without notice.
- GTM semiconductor products are not warranted to be suitable for use in life-support Applications, or systems.
- GTM assumes no liability for any consequence of customer product design, infringement of patents, or application assistance.

Head Office And Factory:

- **Taiwan:** No. 17-1 Tatung Rd. Fu Kou Hsin-Chu Industrial Park, Hsin-Chu, Taiwan, R. O. C.
- TEL : 886-3-597-7061 FAX : 886-3-597-9220, 597-0785
- **China:** (201203) No.255, Jang-Jiang Tsai-Lueng RD. , Pu-Dung-Hsin District, Shang-Hai City, China
- TEL : 86-21-5895-7671 ~ 4 FAX : 86-21-38950165