

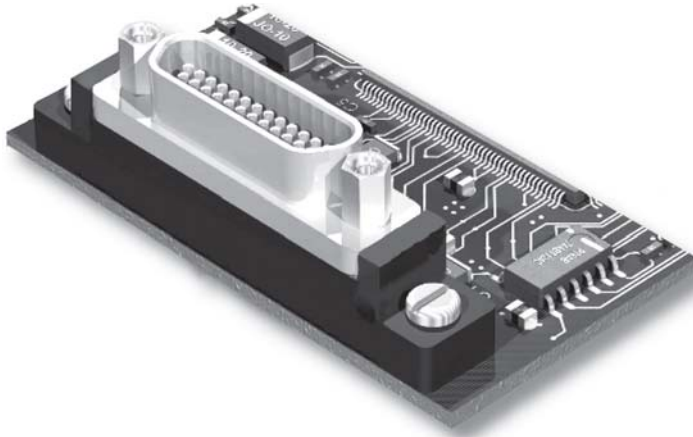

Micro-D Metal Shell Printed Circuit Board Connectors BS Style Vertical Mount Thru-Hole



High Performance—These connectors feature gold-plated TwistPin contacts for best performance. PC tails are .020 inch diameter. Specify nickel-plated shells or cadmium plated shells for best availability.

Solder-Dipped—Terminals are coated with SN63/Pb37 tin-lead solder for best solderability. Optional gold-plated terminals are available for RoHS compliance.

Front Panel or Rear Mountable—Can be installed through panels up to .125 inch thick. Specify rear panel mount jackposts.

HOW TO ORDER BS STYLE PCB MICRO-D CONNECTORS

Series	Shell Material and Finish	Insulator Material	Contact Layout	Contact Type	Termination Type	Jackpost Option	Threaded Insert Option	Terminal Length In Inches	Gold-Plated Terminal Mod Code
MWDM	Aluminum Shell	L – LCP 30% Glass-Filled Liquid Crystal Polymer	9	P Pin	BS Vertical Board Mount	(Omit for None) P – Jackpost	T	.080	These connectors are solder-dipped in 63/37 tin-lead solder. To delete the solder dip and change to gold-plated terminals, add code 513
	1 – Cadmium		15					.110	
	2 – Nickel		21	.125					
	4 – Black Anodize		25	.140					
	5 – Gold		31	.150					
	6 – Chem Film		37	.172					
	Stainless Steel Shell	51	.190						
	3 – Passivated	100	.250						
					S Socket	Jackposts for Rear Panel Mounting	(Omit for Thru-Hole)		
					R1 – .032" Panel				
					R2 – .047" Panel				
					R3 – .062" Panel				
					R4 – .093" Panel				
					R5 – .125" Panel				
Sample Part Number									
MWDM	1	L	- 15	P	BS	R3		- .110	

MICRO-D JACKPOST OPTIONS

No Designator	P	R1 Thru R5
<p>HEX NUT EPOXY FILL</p>		<p>Panel</p>
<p>Thru-Hole</p> <p>For use with Glenair jackposts only. Order hardware separately. Install with threadlocking compound.</p>	<p>Standard Jackpost</p> <p>Factory installed, not intended for removal.</p>	<p>Jackpost for Rear Panel Mounting</p> <p>Shipped loosely installed. Install with permanent threadlocking compound.</p>

Micro-D Metal Shell Printed Circuit Board Connectors BS Style Vertical Mount Thru-Hole



PERFORMANCE SPECIFICATIONS

Current Rating	3 AMP
DWV	600 VAC Sea level
Insulation Resistance	5000 Megohms Minimum
Contact Resistance	8 Milliohms Maximum
Low Level Contact Resist.	32 Milliohms Maximum
Magnetic Permeability	2 μ Maximum
Operating Temperature	-55° C. to +150° C.
Shock, Vibration	50 g., 20g.
Mating Force	(10 Ounces) X (# of Contacts)

MATERIALS AND FINISHES

Connector Shell	Aluminum Alloy 6061 or Stainless Steel, 300 Series, passivated. See Ordering Info for Plating Options
Insulator, Tray	Liquid Crystal Polymer (LCP)
Interfacial Seal	Flourosilicone Rubber, Blue
Pin Contact	Beryllium Copper Gold over Nickel Plating
Socket Contact	Copper Alloy Gold Over Nickel Plating
PCB Terminals	Gold Plated Copper Alloy, Solder Dipped
Hardware	300 Series Stainless Steel
Encapsulant	Epoxy Resin Hysol EE4215

C

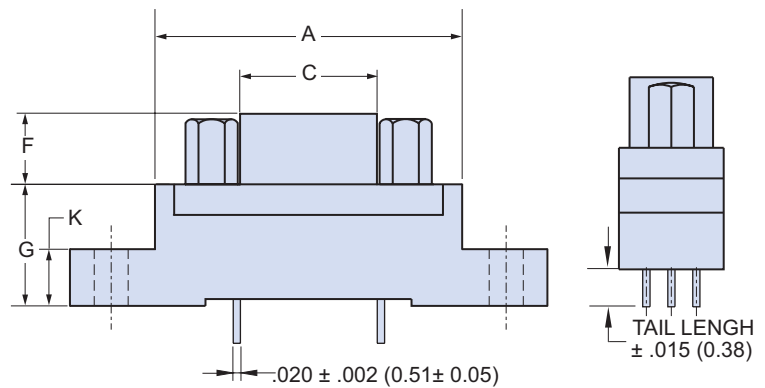
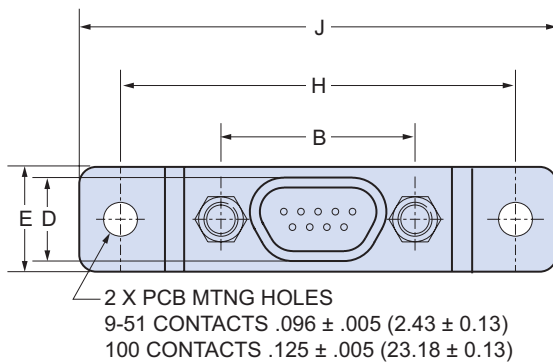

DIMENSIONS

Layout	A Max.		B		C Max.		D Max.		E Max.		F		G		H		J Max.		K	
	In.	mm.	In. \pm .003	mm. \pm 0.08	In.	mm.	In.	mm.	In.	mm.	In. \pm .004	mm. \pm 0.10	In. \pm .010	mm. \pm 0.25	In. \pm .007	mm. \pm 0.18	In.	mm.	In. \pm .010	mm. \pm 0.25
9P	.790	20.07	.565	14.35	.333	8.46	.184	4.67	.310	7.87	.183	4.65	.333	8.46	1.150	29.21	1.390	35.31	.155	3.94
9S	.790	20.07	.565	14.35	.400	10.16	.250	6.35	.310	7.87	.195	4.95	.333	8.46	1.150	29.21	1.390	35.31	.155	3.94
15P	.940	23.88	.715	18.16	.483	12.27	.184	4.67	.310	7.87	.183	4.65	.333	8.46	1.150	29.21	1.390	35.31	.155	3.94
15S	.940	23.88	.715	18.16	.551	14.00	.250	6.35	.310	7.87	.195	4.95	.333	8.46	1.150	29.21	1.390	35.31	.155	3.94
21P	1.180	29.97	.865	21.97	.633	16.08	.184	4.67	.310	7.87	.183	4.65	.333	8.46	1.450	36.83	1.690	42.93	.155	3.94
21S	1.180	29.97	.865	21.97	.701	17.81	.250	6.35	.310	7.87	.195	4.95	.333	8.46	1.450	36.83	1.690	42.93	.155	3.94
25P	1.275	32.39	.965	24.51	.733	18.62	.184	4.67	.310	7.87	.183	4.65	.333	8.46	1.500	38.10	1.740	44.20	.155	3.94
25S	1.275	32.39	.965	24.51	.801	20.35	.250	6.35	.310	7.87	.195	4.95	.333	8.46	1.500	38.10	1.740	44.20	.155	3.94
31P	1.575	40.01	1.115	28.32	.883	22.43	.184	4.67	.310	7.87	.183	4.65	.333	8.46	1.800	45.72	2.040	51.82	.155	3.94
31S	1.575	40.01	1.115	28.32	.951	24.16	.250	6.35	.310	7.87	.195	4.95	.333	8.46	1.800	45.72	2.040	51.82	.155	3.94
37P	1.875	47.63	1.265	32.13	1.033	26.24	.184	4.67	.310	7.87	.183	4.65	.333	8.46	2.100	53.34	2.340	59.44	.155	3.94
37S	1.875	47.63	1.265	32.13	1.101	27.96	.250	6.35	.310	7.87	.195	4.95	.333	8.46	2.100	53.34	2.340	59.44	.155	3.94
51P	1.775	45.09	1.215	30.86	.983	24.97	.224	5.69	.351	8.92	.183	4.65	.333	8.46	2.000	50.80	2.270	57.64	.155	3.94
51S	1.775	45.09	1.215	30.86	1.051	26.70	.293	7.44	.351	8.92	.195	4.95	.333	8.46	2.000	50.80	2.270	57.64	.155	3.94
100P	2.585	65.66	1.800	45.72	1.383	35.13	.270	6.86	.394	10.01	.183	4.65	.525	13.34	2.800	71.12	3.250	82.55	.293	7.44
100S	2.585	65.66	1.800	45.72	1.451	36.86	.333	8.46	.394	10.01	.195	4.95	.525	13.34	2.800	71.12	3.250	82.55	.293	7.44



Micro-D Metal Shell Printed Circuit Board Connectors BS Style Right Angle Thru-Hole

MICRO-D BS BOARD MOUNT CONNECTOR PCB LAYOUTS – PIN CONNECTORS

Patterns shown are for connector mounting side of PC board. 9 Thru 51 Contacts .096 (2.44) Diameter Mounting Holes, 100 Pin .125 (3.18) Diameter

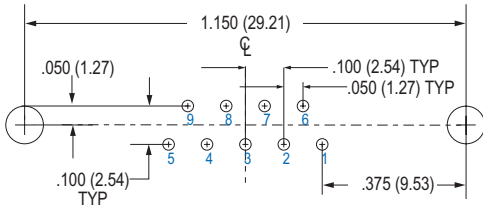

9 PIN MWDM-9PBS

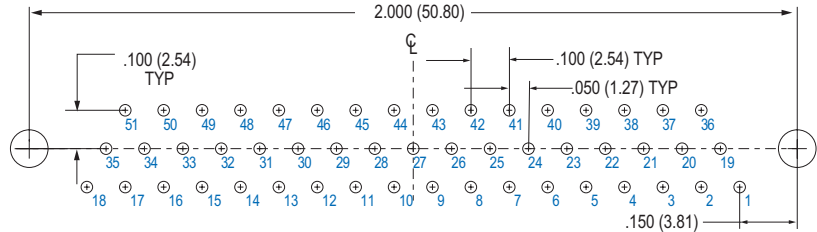

51 PIN MWDM-51PBS

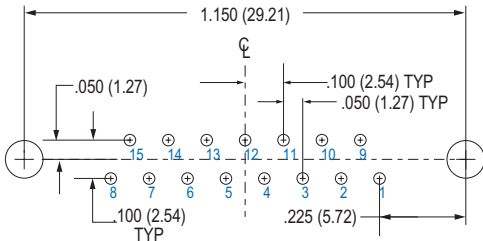

15 PIN MWDM-15PBS

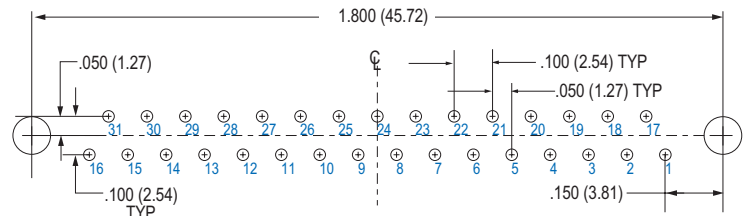

31 PIN MWDM-31PBS

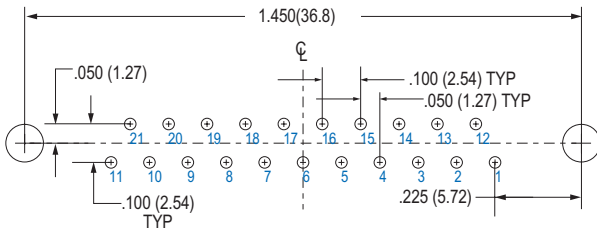

21 PIN MWDM-21PBS

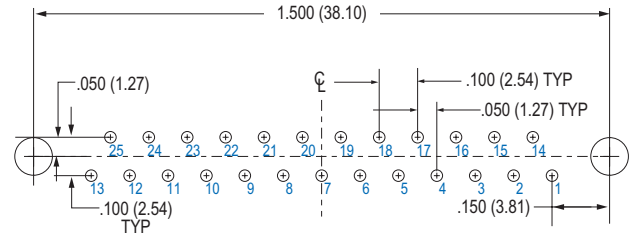

25 PIN MWDM-25PBS

Connector Orientation

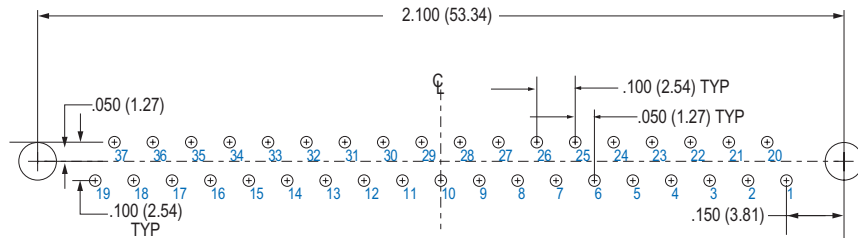
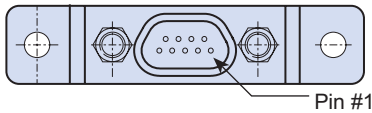

37 PIN MWDM-37PBS

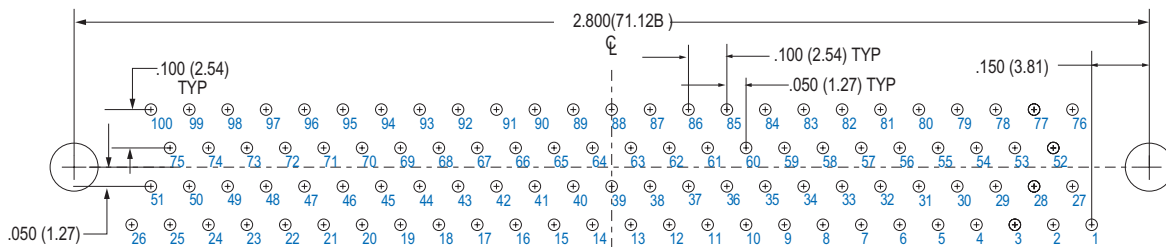

100 PIN MWDM-100PBS

Micro-D Metal Shell Printed Circuit Board Connectors BS Style Right Angle Thru-Hole



MICRO-D BS BOARD MOUNT CONNECTOR PCB LAYOUTS – SOCKET CONNECTORS

Patterns shown are for connector mounting side of PC board. 9 Thru 51 Contacts .096 (2.44) Diameter Mounting Holes, 100 Pin .125 (3.18) Diameter

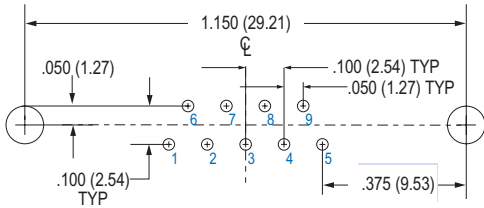

9 SOCKET MWDM-9SBS

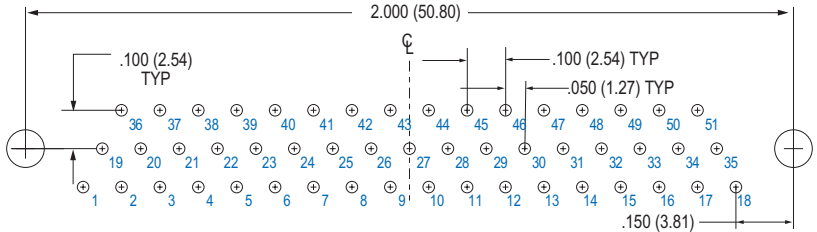

51 SOCKET MWDM-51SBS

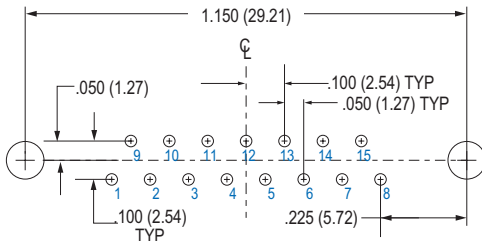

15 SOCKET MWDM-15SBS

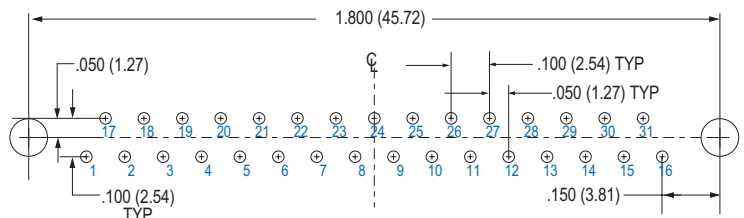

31 SOCKET MWDM-31SBS

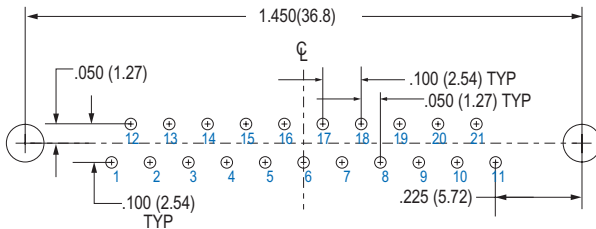

21 SOCKET MWDM-21SBS

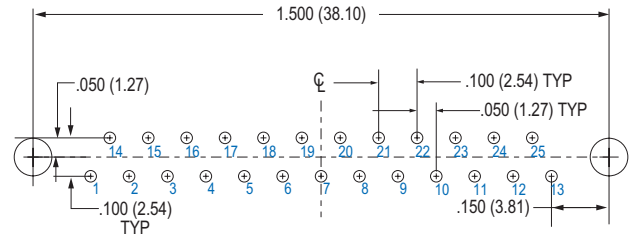

25 SOCKET MWDM-25SBS

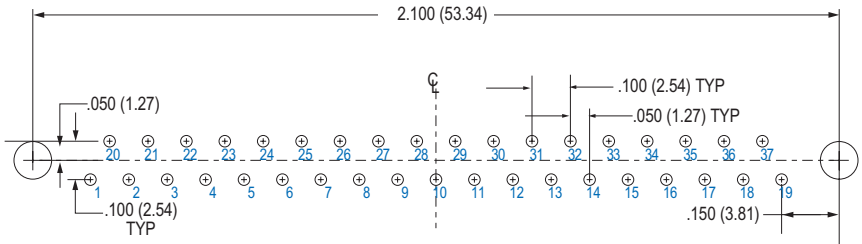
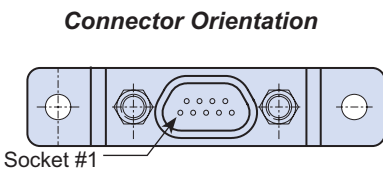

37 SOCKET MWDM-37SBS

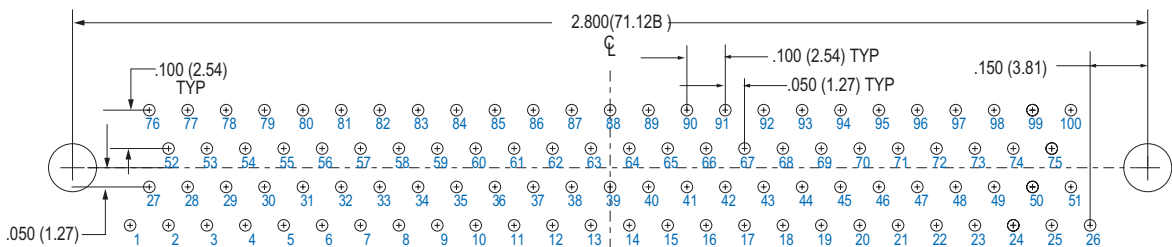

100 SOCKET MWDM-100SBS