



LIS3LV02DL

MEMS INERTIAL SENSOR

3-Axis - $\pm 2g/\pm 6g$ Digital Output Low Voltage Linear Accelerometer

PRELIMINARY DATA

Features

- 2.16V to 3.6V single supply operation
- 1.8V compatible IOs
- I²C/SPI digital output interfaces
- Programmable 12 or 16 bit data representation
- Interrupt activated by motion
- Programmable interrupt threshold
- Embedded self test
- High shock survivability
- ECOPACK® compliant (see [Section 8](#))

Description

The LIS3LV02DL is a three axes digital output linear accelerometer that includes a sensing element and an IC interface able to take the information from the sensing element and to provide the measured acceleration signals to the external world through an I²C/SPI serial interface.

The sensing element, capable of detecting the acceleration, is manufactured using a dedicated process developed by ST to produce inertial sensors and actuators in silicon.

The IC interface instead is manufactured using a CMOS process that allows high level of integration to design a dedicated circuit which is factory trimmed to better match the sensing element characteristics.

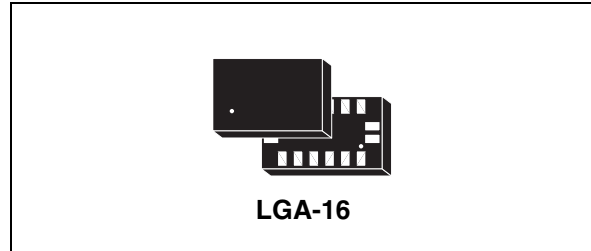

The LIS3LV02DL has a user selectable full scale of $\pm 2g$, $\pm 6g$ and it is capable of measuring acceleration over a bandwidth of 640 Hz for all axes. The device bandwidth may be selected accordingly to the application requirements. A self-test capability allows the user to check the functioning of the system

The device may be configured to generate an inertial wake-up/free-fall interrupt signal when a programmable acceleration threshold is crossed at least in one of the three axes.

The LIS3LV02DL is available in plastic SMD package and it is specified over a temperature range extending from -40°C to $+85^{\circ}\text{C}$.

The LIS3LV02DL belongs to a family of products suitable for a variety of applications:

- Free-Fall detection
- Motion activated functions in portable terminals
- Antitheft systems and Inertial navigation
- Gaming and Virtual Reality input devices
- Vibration Monitoring and Compensation

Order codes

Part number	Op. Temp. range, °C	Package	Packing
LIS3LV02DL	-40 to +85	LGA-16	Tray
LIS3LV02DL-TR	-40 to +85	LGA-16	Tape and Reel

Contents

1	Block Diagram & Pin Description	4
1.1	Block diagram	4
1.2	LGA-16 Pin description	4
2	Mechanical and Electrical specifications	6
2.1	Mechanical characteristics1	6
2.2	Electrical characteristics1	8
2.3	Absolute maximum ratings	9
2.4	Terminology	10
2.4.1	Sensitivity	10
2.4.2	Zero-g level	10
2.4.3	Self Test	10
3	Functionality	11
3.1	Sensing element	11
3.2	IC Interface	11
3.3	Factory calibration	12
4	Application Hints	13
4.1	Soldering Information	13
5	Digital Interfaces	14
5.1	I2C Serial Interface	14
5.1.1	I2C Operation	15
5.2	SPI Bus Interface	16
5.2.1	SPI Read	17
5.2.2	SPI Write	18
5.2.3	SPI Read in 3-wires mode	18
6	Register mapping	20
7	Register Description	22
7.1	WHO_AM_I (0Fh)	22

7.2	OFFSET_X (16h)	22
7.3	OFFSET_Y (17h)	22
7.4	OFFSET_Z (18h)	22
7.5	GAIN_X (19h)	23
7.6	GAIN_Y (1Ah)	23
7.7	GAIN_Z (1Bh)	23
7.8	CTRL_REG1 (20h)	23
7.9	CTRL_REG2 (21h)	24
7.10	CTRL_REG3 (22h)	25
7.11	HP_FILTER_RESET (23h)	26
7.12	STATUS_REG (27h)	26
7.13	OUTX_L (28h)	26
7.14	OUTX_H (29h)	26
7.15	OUTY_L (2Ah)	27
7.16	OUTY_H (2Bh)	27
7.17	OUTZ_L (2Ch)	27
7.18	OUTZ_H (2Dh)	27
7.19	FF_WU_CFG (30h)	28
7.20	FF_WU_SRC (31h)	29
7.21	FF_WU_ACK (32h)	29
7.22	FF_WU_THS_L (34h)	30
7.23	FF_WU_THS_H (35h)	30
7.24	FF_WU_DURATION (36h)	30
7.25	DD_CFG (38h)	31
7.26	DD_SRC (39h)	32
7.27	DD_ACK (3Ah)	32
7.28	DD_THSI_L (3Ch)	33
7.29	DD_THSI_H (3Dh)	33
7.30	DD_THSE_L (3Eh)	33
7.31	DD_THSE_H (3Fh)	33
8	Package Information	34
9	Revision history	35

1 Block Diagram & Pin Description

1.1 Block diagram

Figure 1. Block Diagram

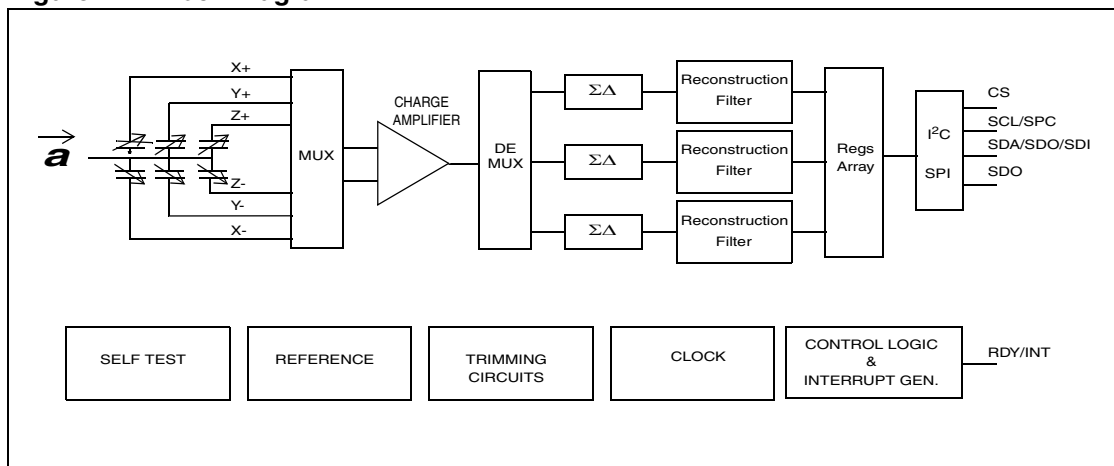

1.2 LGA-16 Pin description

Figure 2. Pin Connection

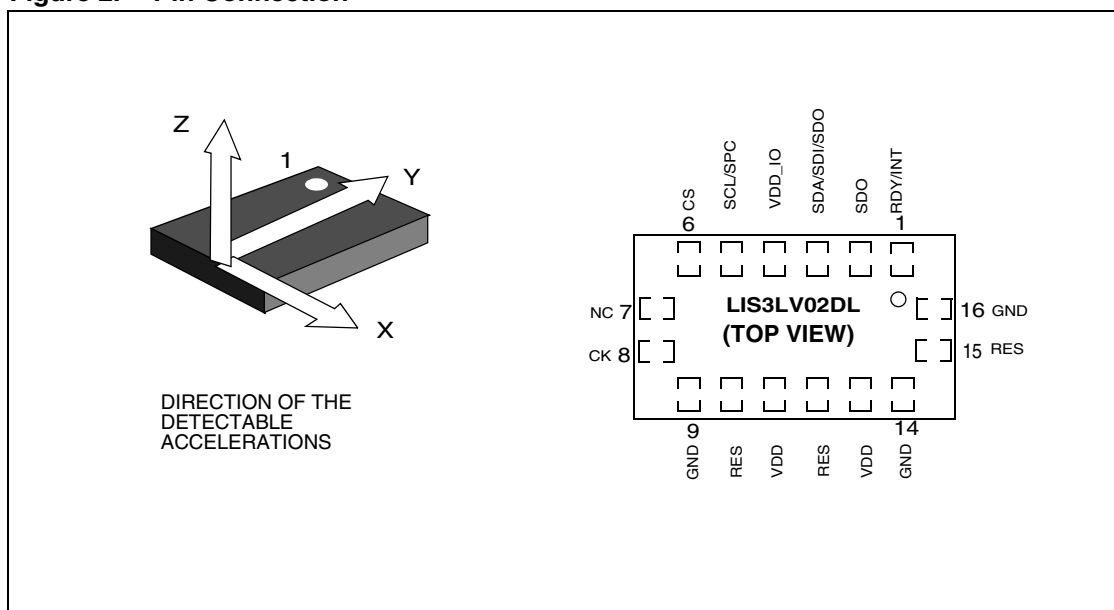

Table 1. Pin description

Pin#	Name	Function
1	RDY/INT	Data ready/inertial wake-up interrupt
2	SDO	SPI Serial Data Output
3	SDA/ SDI/ SDO	I ² C Serial Data (SDA) SPI Serial Data Input (SDI) 3-wire Interface Serial Data Output (SDO)
4	Vdd_IO	Power supply for I/O pads
5	SCL/SPC	I ² C Serial Clock (SCL) SPI Serial Port Clock (SPC)
6	CS	SPI enable I ² C/SPI mode selection (1: I ² C mode; 0: SPI enabled)
7	NC	Internally not connected
8	CK	Optional External clock, if not used either leave unconnected or connect to GND
9	GND	0V supply
10	Reserved	Either leave unconnected or connect to Vdd_IO
11	Vdd	Power supply
12	Reserved	Connect to Vdd
13	Vdd	Power supply
14	GND	0V supply
15	Reserved	Either leave unconnected or connect to GND
16	GND	0V supply

2 Mechanical and Electrical specifications

2.1 Mechanical characteristics¹

Table 2. Mechanical Characteristics

(All the parameters are specified @ Vdd=3.3V, T=25°C unless otherwise noted)

Symbol	Parameter	Test conditions	Min.	Typ. ²	Max.	Unit
FS	Measurement range ³	FS bit set to 0	±1.7	±2.0		g
		FS bit set to 1	±5.3	±6.0		g
Dres	Device Resolution	Full-scale = 2g BW=40Hz		1.0		mg
So	Sensitivity	Full-scale = 2g, 12 bit representation	920	1024	1126	LSb/g
		Full-scale = 6g, 12 bit representation	306	340	374	LSb/g
TCS0	Sensitivity Change Vs Temperature	Full-scale = 2g, 12 bit representation		0.025		%/°C
Off	Zero-g Level Offset Accuracy ^{4,5}	Full-scale = 2g X, Y axis	-70		70	mg
		Full-scale = 2g Z axis	-90		90	mg
		Full-scale = 6g X, Y axis	-90		90	mg
		Full-scale = 6g Z axis	-100		100	mg
LTOff	Zero-g Level Offset Long Term Accuracy ⁶	Full-scale = 2g X, Y axis		TBD		%FS
		Full-scale = 2g Z axis		TBD		%FS
		Full-scale = 6g X, Y axis		TBD		%FS
		Full-scale = 6g Z axis		TBD		%FS
TCOff	Zero-g Level Change Vs Temperature	Max Delta from 25°C		0.2		mg/°C

Table 2. Mechanical Characteristics (continued)

(All the parameters are specified @ Vdd=3.3V, T=25°C unless otherwise noted)

Symbol	Parameter	Test conditions	Min.	Typ. ²	Max.	Unit
NL	Non Linearity	Best fit straight line X, Y axis Full-scale = 2g BW=40Hz		±2		%FS
		Best fit straight line Z axis Full-scale = 2g BW=40Hz		±3		%FS
CrAx	Cross Axis		-3.5		3.5	%
V _{st}	Self test Output Change ^{7,8}	Full-scale=2g X axis	250	550	900	LSb
		Full-scale=2g Y axis	250	550	900	LSb
		Full-scale=2g Z axis	-100	-350	-600	LSb
		Full-scale=6g X axis	80	180	300	LSb
		Full-scale=6g Y axis	80	180	300	LSb
		Full-scale=6g Z axis	-30	-120	-200	LSb
BW	System Bandwidth ⁹			ODRx/4		Hz
Top	Operating Temperature Range		-40		+85	°C
Wh	Product Weight			72		mgram

Note: 1 The product is factory calibrated at 2.5V. The device can be used from 2.16V to 3.6V

2 Typical specifications are not guaranteed

3 Verified by wafer level test and measurement of initial offset and sensitivity

4 Zero-g level offset value after MSL3 preconditioning

5 Offset can be eliminated by enabling the built-in high pass filter (HPF)

6 Results of accelerated reliability tests

7 Self Test output changes with the power supply. Self test "output change" is defined as $OUTPUT[LSb]_{(Self-test\ bit\ on\ ctrl_reg1=1)} - OUTPUT[LSb]_{(Self-test\ bit\ on\ ctrl_reg1=0)}$. 1LSb=1g/1024 at 12bit representation, 2g Full-Scale

8 Output data reach 99% of final value after 5/ODR when enabling Self-Test mode due to device filtering

9 ODR is output data rate. Refer to table 3 for specifications

2.2 Electrical characteristics¹

Table 3. Electrical Characteristics

(All the parameters are specified @ Vdd=2.5V, T=25°C unless otherwise noted)

Symbol	Parameter	Test conditions	Min.	Typ. ²	Max.	Unit
Vdd	Supply voltage		2.16	2.5	3.6	V
Vdd_IO	I/O pads Supply voltage		1.71		Vdd	V
Idd	Supply current	T = 25°C, Vdd=3.3V		0.65	0.80	mA
VIH	Digital High level Input voltage		0.8*Vdd_IO			V
VIL	Digital Low level Input voltage				0.2*Vdd_IO	V
VOH	High level Output Voltage		0.9*Vdd_IO			V
VOL	Low level Output Voltage				0.1*Vdd_IO	V
IddPdn	Current consumption in Power-down mode	T = 25°C		1	10	µA
ODR1	Output Data Rate1	Dec factor = 512		40		Hz
ODR2	Output Data Rate 2	Dec factor = 128		160		Hz
ODR3	Output Data Rate 3	Dec factor = 32		640		Hz
ODR4	Output Data Rate 4	Dec factor = 8		2560		Hz
BW	System Bandwidth ³			ODRx/4		Hz
Ton	Turn-on time ⁴			5/ODRx		s
Fmax	SPI frequency	Vdd_IO<2.4V		4		MHz
		Vdd_IO>2.4V		8		MHz
Top	Operating Temperature Range		-40		+85	°C

Note: 1 The product is factory calibrated at 2.5V. The device can be used from 2.16V to 3.6V

2 Typical specifications are not guaranteed

3 Digital filter cut-off frequency

4 Time to obtain valid data after exiting Power-Down mode

2.3 Absolute maximum ratings

Stresses above those listed as “absolute maximum ratings” may cause permanent damage to the device. This is a stress rating only and functional operation of the device under these conditions is not implied. Exposure to maximum rating conditions for extended periods may affect device reliability.

Table 4. Absolute maximum ratings

Symbol	Ratings	Maximum Value	Unit
V _{DD}	Supply voltage	-0.3 to 6	V
V _{DD_IO}	I/O pins Supply voltage	-0.3 to V _{DD} +0.1	V
V _{IN}	Input voltage on any control pin (CS, SCL/SPC, SDA/SDI/SDO, CK)	-0.3 to V _{DD_IO} +0.3	V
A _{POW}	Acceleration (Any axis, Powered, V _{DD} =2.5V)	3000g for 0.5 ms	
		10000g for 0.1 ms	
A _{UNP}	Acceleration (Any axis, Unpowered)	3000g for 0.5 ms	
		10000g for 0.1 ms	
T _{OP}	Operating Temperature Range	-40 to +85	°C
T _{STG}	Storage Temperature Range	-40 to +125	°C
ESD	Electrostatic discharge protection	4.0 (HBM)	kV
		200 (MM)	V
		1.5 (CDM)	kV

Note: 1 Supply voltage on any pin should never exceed 6.0V.



This is a Mechanical Shock sensitive device, improper handling can cause permanent damages to the part



This is an ESD sensitive device, improper handling can cause permanent damages to the part

2.4 Terminology

2.4.1 Sensitivity

Sensitivity describes the gain of the sensor and can be determined e.g. by applying 1g acceleration to it. As the sensor can measure DC accelerations this can be done easily by pointing the axis of interest towards the center of the earth, noting the output value, rotating the sensor by 180 degrees (point to the sky) and noting the output value again. By doing so, $\pm 1g$ acceleration is applied to the sensor. Subtracting the larger output value from the smaller one and divide the result by 2 leads to the actual sensitivity of the sensor. This value changes very little over temperature and also very little over time. The Sensitivity Tolerance describes the range of Sensitivities of a large population of sensor.

2.4.2 Zero-g level

Zero-g level Offset (Off) describes the deviation of an actual output signal from the ideal output signal if there is no acceleration present. A sensor in a steady state on a horizontal surface will measure 0g in X axis and 0g in Y axis whereas the Z axis will measure 1g. The output is ideally in the middle of the dynamic range of the sensor (content of OUT registers 00h, 00h with 16 bit representation, data expressed as 2's complement number). A deviation from ideal value in this case is called Zero-g offset. Offset is to some extent a result of stress to a precise MEMS sensor and therefore the offset can slightly change after mounting the sensor onto a printed circuit board or exposing it to extensive mechanical stress. Offset changes little over temperature, see "Zero-g level change vs. temperature". The Zero-g level of an individual sensor is stable over lifetime. The Zero-g level tolerance describes the range of Zero-g levels of a population of sensors.

2.4.3 Self Test

Self Test allows to test the mechanical and electric part of the sensor, allowing the seismic mass to be moved by means of an electrostatic test-force. The Self Test function is off when the self-test bit of ctrl_reg1 (control register 1) is programmed to '0'. When the self-test bit of ctrl_reg1 is programmed to '1' an actuation force is applied to the sensor, simulating a definite input acceleration. In this case the sensor outputs will exhibit a change in their DC levels which is related to the selected full scale and depending on the Supply Voltage through the device sensitivity. When Self Test is activated, the device output level is given by the algebraic sum of the signals produced by the acceleration acting on the sensor and by the electrostatic test-force. If the output signals change within the amplitude specified inside table 2 than the sensor is working properly and the parameters of the interface chip are within the defined specification.

3 Functionality

The LIS3LV02DL is a high performance, low-power, digital output 3-axis linear accelerometer packaged in a LGA package. The complete device includes a sensing element and an IC interface able to take the information from the sensing element and to provide a signal to the external world through an I²C/SPI serial interface.

3.1 Sensing element

A proprietary process is used to create a surface micro-machined accelerometer. The technology allows to carry out suspended silicon structures which are attached to the substrate in a few points called anchors and are free to move in the direction of the sensed acceleration. To be compatible with the traditional packaging techniques a cap is placed on top of the sensing element to avoid blocking the moving parts during the moulding phase of the plastic encapsulation.

When an acceleration is applied to the sensor the proof mass displaces from its nominal position, causing an imbalance in the capacitive half-bridge. This imbalance is measured using charge integration in response to a voltage pulse applied to the sense capacitor.

At steady state the nominal value of the capacitors are few pF and when an acceleration is applied the maximum variation of the capacitive load is up to 100fF.

3.2 IC Interface

The complete measurement chain is composed by a low-noise capacitive amplifier which converts into an analog voltage the capacitive unbalancing of the MEMS sensor and by three $\Sigma\Delta$ analog-to-digital converters, one for each axis, that translate the produced signal into a digital bitstream.

The $\Sigma\Delta$ converters are coupled with dedicated reconstruction filters which remove the high frequency components of the quantization noise and provide low rate and high resolution digital words.

The charge amplifier and the $\Sigma\Delta$ converters are operated respectively at 61.5 kHz and 20.5 kHz.

The data rate at the output of the reconstruction depends on the user selected Decimation Factor (DF) and spans from 40 Hz to 2560 Hz.

The acceleration data may be accessed through an I²C/SPI interface thus making the device particularly suitable for direct interfacing with a microcontroller.

The LIS3LV02DL features a Data-Ready signal (RDY) which indicates when a new set of measured acceleration data is available thus simplifying data synchronization in digital system employing the device itself.

The LIS3LV02DL may also be configured to generate an inertial Wake-Up, Direction Detection and Free-Fall interrupt signal accordingly to a programmed acceleration event along the enabled axes.

3.3 Factory calibration

The IC interface is factory calibrated for sensitivity (So) and Zero-g level (Off).

The trimming values are stored inside the device by a non volatile structure. Any time the device is turned on, the trimming parameters are downloaded into the registers to be employed during the normal operation. This allows the user to employ the device without further calibration.

4 Application Hints

Figure 3. LIS3LV02DL Electrical Connection

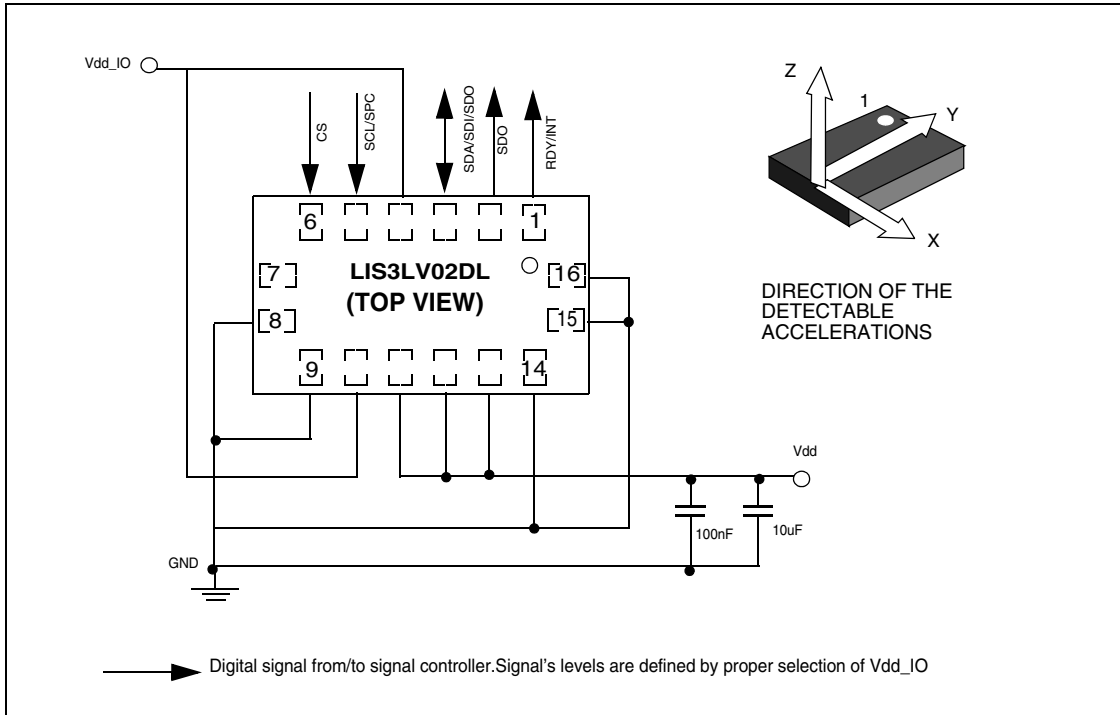

The device core is supplied through Vdd line while the I/O pads are supplied through Vdd_IO line. Power supply decoupling capacitors (100 nF ceramic, 10 μ F Al) should be placed as near as possible to the pin 13 of the device (common design practice).

All the voltage and ground supplies must be present at the same time to have proper behavior of the IC (refer to Fig. 3). It is possible to remove Vdd maintaining Vdd_IO without blocking the communication busses.

The functionality of the device and the measured acceleration data is selectable and accessible through the I²C/SPI interface. When using the I²C, CS must be tied high while SDO must be left floating. Refer to dedicated application note for further information on device usage.

4.1 Soldering Information

The LGA-16 package is lead free and green package qualified for soldering heat resistance according to JEDEC J-STD-020C. Pin #1 indicator are physically connected to GND. Soldering recommendations are available upon request.

5 Digital Interfaces

The registers embedded inside the LIS3LV02DL may be accessed through both the I²C and SPI serial interfaces. The latter may be SW configured to operate either in 3-wire or 4-wire interface mode.

The serial interfaces are mapped onto the same pads. To select/exploit the I²C interface, CS line must be tied high (i.e connected to Vdd_IO).

Table 5. Serial interface pin description

PIN Name	PIN Description
CS	SPI enable I ² C/SPI mode selection (1: I ² C mode; 0: SPI enabled)
SCL/SPC	I ² C Serial Clock (SCL) SPI Serial Port Clock (SPC)
SDA/SDI/SDO	I ² C Serial Data (SDA) SPI Serial Data Input (SDI) 3-wire Interface Serial Data Output (SDO)
SDO	SPI Serial Data Output (SDO)

5.1 I²C Serial Interface

The LIS3LV02DL I²C is a bus slave. The I²C is employed to write the data into the registers whose content can also be read back.

The relevant I²C terminology is given in the table below

Table 6. Serial interface pin description

Term	Description
Transmitter	The device which sends data to the bus
Receiver	The device which receives data from the bus
Master	The device which initiates a transfer, generates clock signals and terminates a transfer
Slave	The device addressed by the master

There are two signals associated with the I²C bus: the Serial Clock Line (SCL) and the Serial Data line (SDA). The latter is a bidirectional line used for sending and receiving the data to/from the interface. Both the lines are connected to Vdd_IO through a pull-up resistor embedded inside the LIS3LV02DL. When the bus is free both the lines are high.

The I²C interface is compliant with Fast Mode (400 kHz) I²C standards as well as the Normal Mode.

5.1.1 I²C Operation

The transaction on the bus is started through a START (ST) signal. A START condition is defined as a HIGH to LOW transition on the data line while the SCL line is held HIGH. After this has been transmitted by the Master, the bus is considered busy. The next byte of data transmitted after the start condition contains the address of the slave in the first 7 bits and the eighth bit tells whether the Master is receiving data from the slave or transmitting data to the slave. When an address is sent, each device in the system compares the first seven bits after a start condition with its address. If they match, the device considers itself addressed by the Master. The Slave ADDRESS (SAD) associated to the LIS3LV02DL is 0011101b.

Data transfer with acknowledge is mandatory. The transmitter must release the SDA line during the acknowledge pulse. The receiver must then pull the data line LOW so that it remains stable low during the HIGH period of the acknowledge clock pulse. A receiver which has been addressed is obliged to generate an acknowledge after each byte of data has been received.

The I²C embedded inside the LIS3LV02DL behaves like a slave device and the following protocol must be adhered to. After the start condition (ST) a slave address is sent, once a slave acknowledge (SAK) has been returned, a 8-bit sub-address will be transmitted: the 7 LSB represent the actual register address while the MSB enables address auto increment. If the MSb of the SUB field is 1, the SUB (register address) will be automatically incremented to allow multiple data read/write.

The slave address is completed with a Read/Write bit. If the bit was '1' (Read), a repeated START (SR) condition will have to be issued after the two sub-address bytes; if the bit is '0' (Write) the Master will transmit to the slave with direction unchanged.

Transfer when Master is writing one byte to slave

Master	ST	SAD + W		SUB		DATA		SP
Slave			SAK		SAK		SAK	

Transfer when Master is writing multiple bytes to slave:

Master	ST	SAD + W		SUB		DATA		DATA		SP
Slave			SAK		SAK		SAK		SAK	

Transfer when Master is receiving (reading) one byte of data from slave:

Master	ST	SAD + W		SUB		SR	SAD + R			NMAK	SP
Slave			SAK		SAK			SAK	DATA		

Transfer when Master is receiving (reading) multiple bytes of data from slave

Master	ST	SAD + W		SUB		SR	SAD + R			MAK
Slave			SAK		SAK			SAK	DATA	

Master				MAK				NMAK	SP
Slave		DATA				DATA			

Data are transmitted in byte format (DATA). Each data transfer contains 8 bits. The number of bytes transferred per transfer is unlimited. Data is transferred with the Most Significant bit (MSb) first. If a receiver can't receive another complete byte of data until it has performed some other

function, it can hold the clock line, SCL LOW to force the transmitter into a wait state. Data transfer only continues when the receiver is ready for another byte and releases the data line. If a slave receiver doesn't acknowledge the slave address (i.e. it is not able to receive because it is performing some real time function) the data line must be left HIGH by the slave. The Master can then abort the transfer. A LOW to HIGH transition on the SDA line while the SCL line is HIGH is defined as a STOP condition. Each data transfer must be terminated by the generation of a STOP (SP) condition.

In order to read multiple bytes, it is necessary to assert the most significant bit of the sub-address field. In other words, SUB(7) must be equal to 1 while SUB(6-0) represents the address of first register to read.

In the presented communication format MAK is Master Acknowledge and NMAK is No Master Acknowledge.

5.2 SPI Bus Interface

The LIS3LV02DL SPI is a bus slave. The SPI allows to write and read the registers of the device.

The Serial Interface interacts with the outside world with 4 wires: **CS**, **SPC**, **SDI** and **SDO**.

Figure 4. Read & write protocol

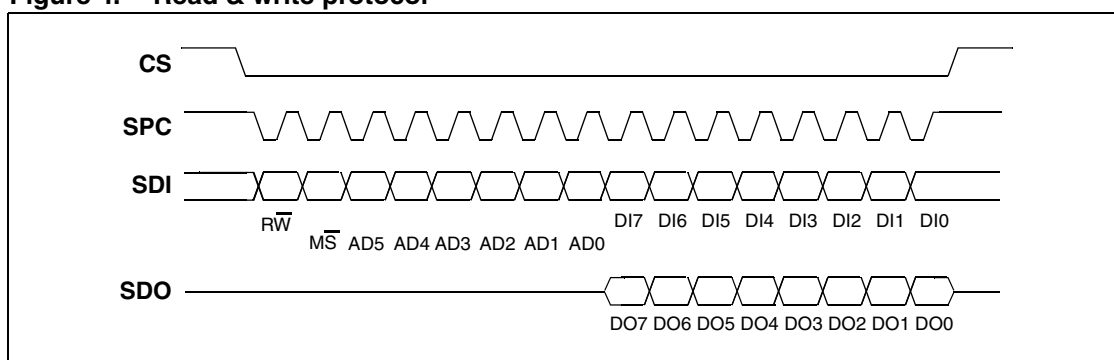

CS is the Serial Port Enable and it is controlled by the SPI master. It goes low at the start of the transmission and goes back high at the end. **SPC** is the Serial Port Clock and it is controlled by the SPI master. It is stopped high when **CS** is high (no transmission). **SDI** and **SDO** are respectively the Serial Port Data Input and Output. Those lines are driven at the falling edge of **SPC** and should be captured at the rising edge of **SPC**.

Both the Read Register and Write Register commands are completed in 16 clock pulses or in multiple of 8 in case of multiple byte read/write. Bit duration is the time between two falling edges of **SPC**. The first bit (bit 0) starts at the first falling edge of **SPC** after the falling edge of **CS** while the last bit (bit 15, bit 23, ...) starts at the last falling edge of **SPC** just before the rising edge of **CS**.

bit 0: \overline{RW} bit. When 0, the data DI(7:0) is written into the device. When 1, the data DO(7:0) from the device is read. In latter case, the chip will drive **SDO** at the start of bit 8.

bit 1: \overline{MS} bit. When 0, the address will remain unchanged in multiple read/write commands. When 1, the address will be auto incremented in multiple read/write commands.

bit 2-7: address AD(5:0). This is the address field of the indexed register.

bit 8-15: data DI(7:0) (write mode). This is the data that will be written into the device (MSb first).

bit 8-15: data DO(7:0) (read mode). This is the data that will be read from the device (MSb first).

In multiple read/write commands further blocks of 8 clock periods will be added. When \overline{MS} bit is 0 the address used to read/write data remains the same for every block. When \overline{MS} bit is 1 the address used to read/write data is incremented at every block.

The function and the behavior of **SDI** and **SDO** remain unchanged.

5.2.1 SPI Read

Figure 5. SPI Read protocol

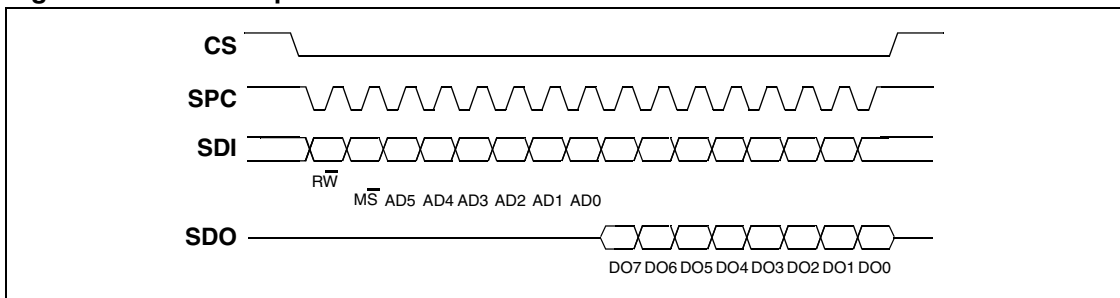

The SPI Read command is performed with 16 clock pulses. Multiple byte read command is performed adding blocks of 8 clock pulses at the previous one.

bit 0: READ bit. The value is 1.

bit 1: \overline{MS} bit. When 0 do not increment address, when 1 increment address in multiple reading.

bit 2-7: address AD(5:0). This is the address field of the indexed register.

bit 8-15: data DO(7:0) (read mode). This is the data that will be read from the device (MSb first).

bit 16-... : data DO(...-8). Further data in multiple byte reading.

Figure 6. Multiple bytes SPI Read Protocol (2 bytes example)

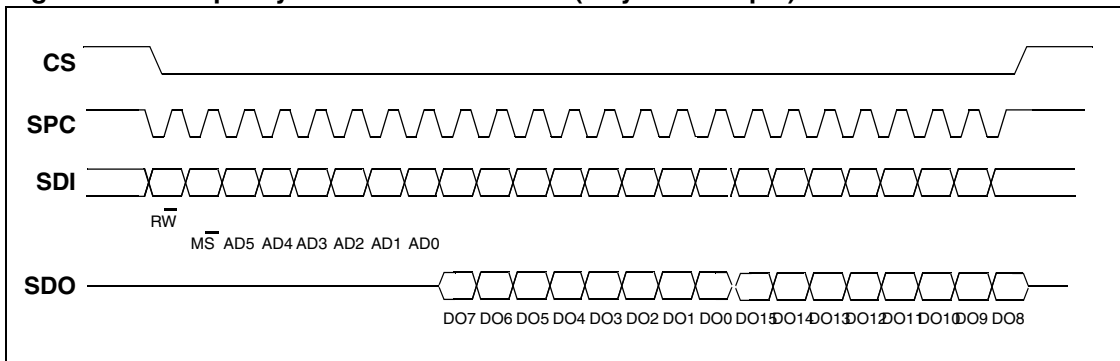

5.2.2 SPI Write

Figure 7. SPI Write protocol

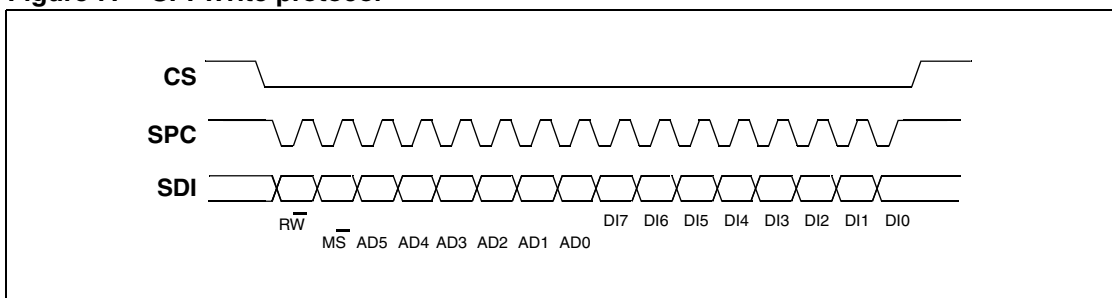

The SPI Write command is performed with 16 clock pulses. Multiple byte write command is performed adding blocks of 8 clock pulses at the previous one.

bit 0: WRITE bit. The value is 0.

bit 1: \overline{MS} bit. When 0 do not increment address, when 1 increment address in multiple writing.

bit 2 -7: address AD(5:0). This is the address field of the indexed register.

bit 8-15: data DI(7:0) (write mode). This is the data that will be written inside the device (MSb first).

bit 16-... : data DI(...-8). Further data in multiple byte writing.

Figure 8. Multiple bytes SPI Write Protocol (2 bytes example)

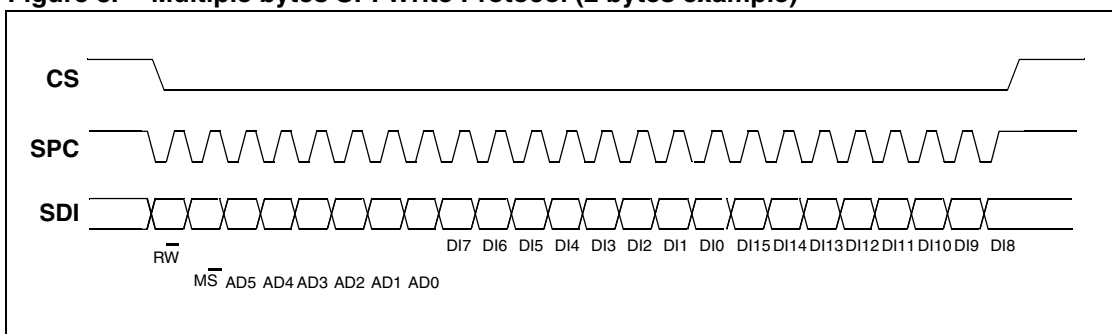

5.2.3 SPI Read in 3-wires mode

3-wires mode is entered by setting to 1 bit SIM (SPI Serial Interface Mode selection) in CTRL_REG2.

Figure 9. SPI Read protocol in 3-wires mode

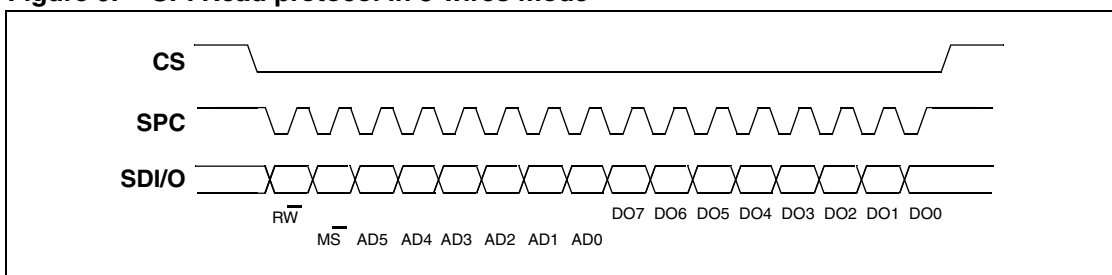

The SPI Read command is performed with 16 clock pulses:

bit 0: READ bit. The value is 1.

bit 1: \overline{MS} bit. When 0 do not increment address, when 1 increment address in multiple reading.

bit 2-7: address AD(5:0). This is the address field of the indexed register.

bit 8-15: data DO(7:0) (read mode). This is the data that will be read from the device (MSb first).

Multiple read command is also available in 3-wires mode.

6 Register mapping

The table given below provides a listing of the 8 bit registers embedded in the device and the related address.

Table 7. Registers address map

Reg. Name	Type	Register Address		Default	Comment
		Binary	Hex		
	rw	0000000 - 0001110	00 - 0E		Reserved
WHO_AM_I	r	0001111	0F	00111010	Dummy register
	rw	0010000 - 0010101	10-15		Reserved
OFFSET_X	rw	0010110	16	Calibration	Loaded at boot
OFFSET_Y	rw	0010111	17	Calibration	Loaded at boot
OFFSET_Z	rw	0011000	18	Calibration	Loaded at boot
GAIN_X	rw	0011001	19	Calibration	Loaded at boot
GAIN_Y	rw	0011010	1A	Calibration	Loaded at boot
GAIN_Z	rw	0011011	1B	Calibration	Loaded at boot
		0011100 -0011111	1C-1F		Reserved
CTRL_REG1	rw	0100000	20	00000111	
CTRL_REG2	rw	0100001	21	00000000	
CTRL_REG3	rw	0100010	22	00001000	
HP_FILTER RESET	r	0100011	23	dummy	Dummy register
		0100100-0100110	24-26		Not Used
STATUS_REG	rw	0100111	27	00000000	
OUTX_L	r	0101000	28	output	
OUTX_H	r	0101001	29	output	
OUTY_L	r	0101010	2A	output	
OUTY_H	r	0101011	2B	output	
OUTZ_L	r	0101100	2C	output	
OUTZ_H	r	0101101	2D	output	
	r	0101110	2E		Reserved
		0101111	2F		Not Used
FF_WU_CFG	rw	0110000	30	00000000	
FF_WU_SRC	rw	0110001	31	00000000	
FF_WU_ACK	r	0110010	32	dummy	Dummy register
		0110011	33		Not Used
FF_WU_THS_L	rw	0110100	34	00000000	

Table 7. Registers address map (continued)

Reg. Name	Type	Register Address		Default	Comment
		Binary	Hex		
FF_WU_THS_H	rw	0110101	35	00000000	
FF_WU_DURATION	rw	0110110	36	00000000	
		0110111	37		Not Used
DD_CFG	rw	0111000	38	00000000	
DD_SRC	rw	0111001	39	00000000	
DD_ACK	r	0111010	3A	dummy	Dummy register
		0111011	3B		Not Used
DD_THSI_L	rw	0111100	3C	00000000	
DD_THSI_H	rw	0111101	3D	00000000	
DD_THSE_L	rw	0111110	3E	00000000	
DD_THSE_H	rw	0111111	3F	00000000	
		1000000-1111111	40-7F		Reserved

Registers marked as reserved must not be changed. The writing to those registers may cause permanent damages to the device.

The content of the registers that are loaded at boot should not be changed. They contain the factory calibration values. Their content is automatically restored when the device is powered-up.

7 Register Description

The device contains a set of registers which are used to control its behavior and to retrieve acceleration data. The registers 7.2 to 7.7 contain the factory calibration values, it is not necessary to change their value for normal device operation.

7.1 WHO_AM_I (0Fh)

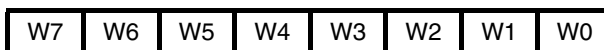

W7, W0	LIS3LV02DL Physical Address equal to 3Ah
--------	--

Addressing this register the physical address of the device is returned. For LIS3LV02DL the physical address assigned in factory is 3Ah.

7.2 OFFSET_X (16h)

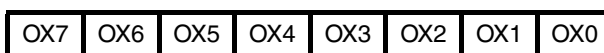

OX7, OX0	Digital Offset Trimming for X-Axis
----------	------------------------------------

7.3 OFFSET_Y (17h)

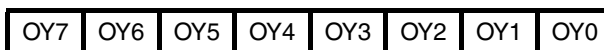

OY7, OY0	Digital Offset Trimming for Y-Axis
----------	------------------------------------

7.4 OFFSET_Z (18h)

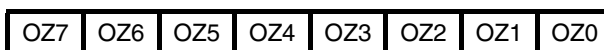

OZ7, OZ0	Digital Offset Trimming for Z-Axis
----------	------------------------------------

7.5 GAIN_X (19h)

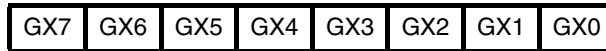

GX7, GX0	Digital Gain Trimming for X-Axis
----------	----------------------------------

7.6 GAIN_Y (1Ah)

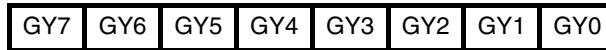

GY7, GY0	Digital Gain Trimming for Y-Axis
----------	----------------------------------

7.7 GAIN_Z (1Bh)

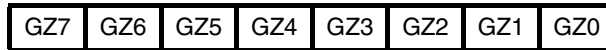

GZ7, GZ0	Digital Gain Trimming for Z-Axis
----------	----------------------------------

7.8 CTRL_REG1 (20h)

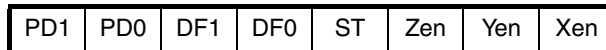

PD1, PD0	Power Down Control (00: power-down mode; 01, 10, 11: device on)
DF1, DF0	Decimation Factor Control (00: decimate by 512; 01: decimate by 128; 10: decimate by 32; 11: decimate by 8)
ST	Self Test Enable (0: normal mode; 1: self-test active)
Zen	Z-axis enable (0: axis off; 1: axis on)
Yen	Y-axis enable (0: axis off; 1: axis on)
Xen	X-axis enable (0: axis off; 1: axis on)

PD1, PD0 bit allows to turn on the turn the device out of power-down mode. The device is in power-down mode when PD1, PD0= "00" (default value after boot). The device is in normal mode when either PD1 or PD0 is set to 1.

DF1, DF0 bit allows to select the data rate at which acceleration samples are produced. The default value is 00 which corresponds to a data-rate of 40Hz. By changing the content of DF1, DF0 to "01", "10" and "11" the selected data-rate will be set respectively equal to 160Hz, 640Hz and to 2560Hz.

ST bit is used to activate the self test function. When the bit is set to one, an output change will occur to the device outputs (refer to table 2 and 3 for specification) thus allowing to check the functionality of the whole measurement chain.

Zen bit enables the Z-axis measurement channel when set to 1. The default value is 1.

Yen bit enables the Y-axis measurement channel when set to 1. The default value is 1.

Xen bit enables the X-axis measurement channel when set to 1. The default value is 1.

7.9 CTRL_REG2 (21h)

FS	BDU	BLE	BOOT	IEN	DRDY	SIM	DAS
----	-----	-----	------	-----	------	-----	-----

FS	Full Scale selection (0: $\pm 2g$; 1: $\pm 6g$)
BDU	Block Data Update (0: continuous update; 1: output registers not updated until MSB and LSB reading)
BLE	Big/Little Endian selection (0: little endian; 1: big endian)
BOOT	Reboot memory content
IEN	Interrupt ENable (0: data ready on RDY pad; 1: int req on RDY pad)
DRDY	Enable Data-Ready generation
SIM	SPI Serial Interface Mode selection (0: 4-wire interface; 1: 3-wire interface)
DAS	Data Alignment Selection (0: 12 bit right justified; 1: 16 bit left justified)

FS bit is used to select Full Scale value. After the device power-up the default full scale value is $\pm 2g$. In order to obtain a $\pm 6g$ full scale it is necessary to set FS bit to '1'.

BDU bit is used to inhibit output registers update until both upper and lower register parts are read. In default mode (BDU= '0') the output register values are updated continuously. If for any reason it is not sure to read faster than output data rate it is recommended to set BDU bit to '1'. In this way the content of output registers is not updated until both MSB and LSB are read avoiding to read values related to different sample time.

BLE bit is used to select Big Endian or Little Endian representation for output registers. In Big Endian's one MSB acceleration value is located at addresses 28h (X-axis), 2Ah (Y-axis) and 2Ch (Z-axis) while LSB acceleration value is located at addresses 29h (X-axis), 2Bh (Y-axis) and 2Dh (Z-axis). In Little Endian representation (Default, BLE='0') the order is inverted (refer to data register description for more details).

BOOT bit is used to refresh the content of internal registers stored in the flash memory block. At the device power up the content of the flash memory block is transferred to the internal registers related to trimming functions to permit a good behavior of the device itself. If for any reason the content of trimming registers was changed it is sufficient to use this bit to restore correct values. When BOOT bit is set to '1' the content of internal flash is copied inside corresponding internal registers and it is used to calibrate the device. These values are factory

trimmed and they are different for every accelerometer. They permit a good behavior of the device and normally they have not to be changed. At the end of the boot process the BOOT bit is set again to '0'.

IEN bit is used to switch the value present on data-ready pad between Data-Ready signal and Interrupt signal. At power up the Data-ready signal is chosen. It is however necessary to modify DRDY bit to enable Data-Ready signal generation.

DRDY bit is used to enable Data-Ready (RDY/INT) pin activation. If DRDY bit is '0' (default value) on Data-Ready pad a '0' value is present. If a Data-Ready signal is desired it is necessary to set to '1' DRDY bit. Data-Ready signal goes to '1' whenever a new data is available for all the enabled axis. For example if Z-axis is disabled, Data-Ready signal goes to '1' when new values are available for both X and Y axis. Data-Ready signal comes back to '0' when all the registers containing values of the enabled axis are read. To be sure not to lose any data coming from the accelerometer data registers must be read before a new Data-Ready rising edge is generated. In this case Data-ready signal will have the same frequency of the data rate chosen.

SIM bit selects the SPI Serial Interface Mode. When SIM is '0' (default value) the 4-wire interface mode is selected. The data coming from the device are sent to SDO pad. In 3-wire interface mode output data are sent to SDA_SDI pad.

DAS bit permits to decide between 12 bit right justified and 16 bit left justified representation of data coming from the device. The first case is the default case and the most significant bits are replaced by the bit representing the sign.

7.10 CTRL_REG3 (22h)

ECK	HPDD	HPFF	FDS	res	res	CFS1	CFS0
-----	------	------	-----	-----	-----	------	------

ECK	External Clock. Default value: 0 (0: clock from internal oscillator; 1: clock from external pad)
HPDD	High Pass filter enabled for Direction Detection. Default value: 0 (0: filter bypassed; 1: filter enabled)
HPFF	High Pass filter enabled for Free-Fall and Wake-Up. Default value: 0 (0: filter bypassed; 1: filter enabled)
FDS	Filtered Data Selection. Default value: 0 (0: internal filter bypassed; 1: data from internal filter)
CFS1, CFS0	High-pass filter Cut-off Frequency Selection. Default value: 00 (00: Hpc=512 01: Hpc=1024 10: Hpc=2048 11: Hpc=4096)

FDS bit enables (FDS=1) or bypass (FDS=0) the high pass filter in the signal chain of the sensor

CFS1, CFS0 bits defines the coefficient Hpc to be used to calculate the -3dB cut-off frequency of the high pass filter:

$$f_{\text{cutoff}} = \frac{0.318}{\text{Hpc}} \cdot \frac{\text{ODRx}}{2}$$

7.11 HP_FILTER_RESET (23h)

Dummy register. Reading at this address zeroes instantaneously the content of the internal high pass-filter. Read data is not significant.

7.12 STATUS_REG (27h)

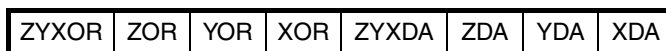

ZYXOR	X, Y and Z axis Data Overrun
ZOR	Z axis Data Overrun
YOR	Y axis Data Overrun
XOR	X axis Data Overrun
ZYXDA	X, Y and Z axis new Data Available
ZDA	Z axis new Data Available
YDA	Y axis new Data Available
XDA	X axis new Data Available

7.13 OUTX_L (28h)

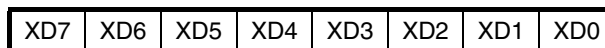

XD7, XD0	X axis acceleration data LSB
----------	------------------------------

In Big Endian Mode (bit BLE_CTRL_REG2 set to '1') the content of this register is the MSB acceleration data and depends by bit DAS in CTRL_REG2 reg as described in the following section.

7.14 OUTX_H (29h)

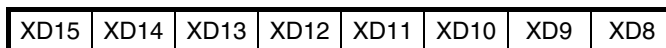

XD15, XD8	X axis acceleration data MSB
-----------	------------------------------

When reading the register in "12 bit right justified" mode the most significant bits (15:12) are replaced with bit 11 (i.e. XD15-XD12=XD11, XD11, XD11, XD11).

In Big Endian Mode (bit BLE_CTRL_REG2 set to '1') the content of this register is the LSB acceleration data.

7.15 OUTY_L (2Ah)

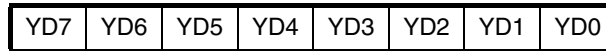

YD7, YD0	Y axis acceleration data LSB
----------	------------------------------

In Big Endian Mode (bit BLE_CTRL_REG2 set to '1') the content of this register is the MSB acceleration data and depends by bit DAS in CTR_REG2 reg as described in the following section.

7.16 OUTY_H (2Bh)

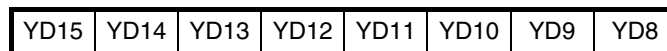

YD15, YD8	Y axis acceleration data MSB
-----------	------------------------------

When reading the register in "12 bit right justified" mode the most significant bits (15:12) are replaced with bit 11 (i.e. YD15-YD12=YD11, YD11, YD11, YD11).

In Big Endian Mode (bit BLE_CTRL_REG2 set to '1') the content of this register is the LSB acceleration data.

7.17 OUTZ_L (2Ch)

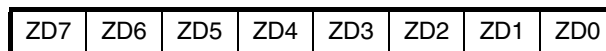

ZD7, ZD0	Z axis acceleration data LSB
----------	------------------------------

In Big Endian Mode (bit BLE_CTRL_REG2 set to '1') the content of this register is the MSB acceleration data and depends by bit DAS in CTR_REG2 reg as described in the following section.

7.18 OUTZ_H (2Dh)

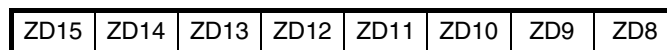

ZD15, ZD8	Z axis acceleration data MSB
-----------	------------------------------

When reading the register in "12 bit right justified" mode the most significant bits (15:12) are replaced with bit 11 (i.e. ZD15-ZD12=ZD11, ZD11, ZD11, ZD11).

In Big Endian Mode (bit BLE_CTRL_REG2 set to '1') the content of this register is the LSB acceleration data

7.19 FF_WU_CFG (30h)

AOI	LIR	ZHIE	ZLIE	YHIE	YLIE	XHIE	XLIE
-----	-----	------	------	------	------	------	------

AOI	And/Or combination of Interrupt events interrupt request. Default value: 0. (0: OR combination of interrupt events; 1: AND combination of interrupt events)
LIR	Latch interrupt request. Default value: 0. (0: interrupt request not latched; 1: interrupt request latched)
ZHIE	Enable Interrupt request on Z high event. Default value: 0. (0: disable interrupt request; 1: enable interrupt request on measured accel. value higher than preset threshold)
ZLIE	Enable Interrupt request on Z low event. Default value: 0. (0: disable interrupt request; 1: enable interrupt request on measured accel. value lower than preset threshold)
YHIE	Enable Interrupt request on Y high event. Default value: 0. (0: disable interrupt request; 1: enable interrupt request on measured accel. value higher than preset threshold)
YLIE	Enable Interrupt request on Y low event. Default value: 0. (0: disable interrupt request; 1: enable interrupt request on measured accel. value lower than preset threshold)
XHIE	Enable Interrupt request on X high event. Default value: 0. (0: disable interrupt request; 1: enable interrupt request on measured accel. value higher than preset threshold)
XLIE	Enable Interrupt request on X low event. Default value: 0. (0: disable interrupt request; 1: enable interrupt request on measured accel. value lower than preset threshold)

Free-fall and inertial wake-up configuration register.

7.20 FF_WU_SRC (31h)

X	IA	ZH	ZL	YH	YL	XH	XL
---	----	----	----	----	----	----	----

IA	Interrupt Active. Default value: 0 (0: no interrupt has been generated; 1: one or more interrupt event has been generated)
ZH	Z High. Default value: 0 (0: no interrupt; 1: ZH event has occurred)
ZL	Z Low. Default value: 0 (0: no interrupt; 1: ZL event has occurred)
YH	Y High. Default value: 0 (0: no interrupt; 1: YH event has occurred)
YL	Y Low. Default value: 0 (0: no interrupt; 1: YL event has occurred)
XH	X High. Default value: 0 (0: no interrupt; 1: XH event has occurred)
XL	X Low. Default value: 0 (0: no interrupt; 1: XL event has occurred)

7.21 FF_WU_ACK (32h)

Dummy register. If LIR bit in FF_WU_CFG=1 allows the refresh of FF_WU_SRC. Read data is not significant.

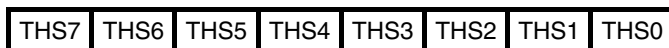
7.22 FF_WU_THS_L (34h)

THS7, THS0	Free-fall / Inertial Wake Up Acceleration Threshold LSB
------------	---

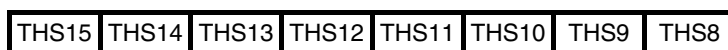
7.23 FF_WU_THS_H (35h)

THS15, THS8	Free-fall / Inertial Wake Up Acceleration Threshold MSB
-------------	---

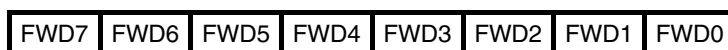
7.24 FF_WU_DURATION (36h)

FWD7, FWD0	Minimum duration of the Free-fall/Wake-up event
------------	---

Set the minimum duration of the free-fall/wake-up event to be recognized.

$$\text{Duration(s)} = \frac{\text{FF_WU_Duration (Dec)}}{\text{ODR}}$$

7.25 DD_CFG (38h)

IEND	LIR	ZHIE	ZLIE	YHIE	YLIE	XHIE	XLIE
------	-----	------	------	------	------	------	------

IEND	Interrupt enable on Direction change. Default value: 0 (0: disabled; 1: interrupt signal enabled)
LIR	Latch Interrupt request into DD_SRC reg with the DD_SRC reg cleared by reading DD_ACK reg. Default value: 0. (0: interrupt request not latched; 1: interrupt request latched)
ZHIE	Enable interrupt generation on Z high event. Default value: 0 (0: disable interrupt request; 1: enable interrupt request on measured accel. value higher than preset threshold)
ZLIE	Enable interrupt generation on Z low event. Default value: 0 (0: disable interrupt request; 1: enable interrupt request on measured accel. value lower than preset threshold)
YHIE	Enable interrupt generation on Y high event. Default value: 0 (0: disable interrupt request; 1: enable interrupt request on measured accel. value higher than preset threshold)
YLIE	Enable interrupt generation on Y low event. Default value: 0 (0: disable interrupt request; 1: enable interrupt request on measured accel. value lower than preset threshold)
XHIE	Enable interrupt generation on X high event. Default value: 0 (0: disable interrupt request; 1: enable interrupt request on measured accel. value higher than preset threshold)
XLIE	Enable interrupt generation on X low event. Default value: 0 (0: disable interrupt request; 1: enable interrupt request on measured accel. value lower than preset threshold)

Direction-detector configuration register

7.26 DD_SRC (39h)

X	IA	ZH	ZL	YH	YL	XH	XL
---	----	----	----	----	----	----	----

IA	Interrupt event from direction change. (0: no direction changes detected; 1: direction has changed from previous measurement)
ZH	Z High. Default value: 0 (0: Z below THSI threshold; 1: Z accel. exceeding THSE threshold along positive direction of acceleration axis)
ZL	Z Low. Default value: 0 (0: Z below THSI threshold; 1: Z accel. exceeding THSE threshold along negative direction of acceleration axis)
YH	Y High. Default value: 0 (0: Y below THSI threshold; 1: Y accel. exceeding THSE threshold along positive direction of acceleration axis)
YL	Y Low. Default value: 0 (0: Y below THSI threshold; 1: Y accel. exceeding THSE threshold along negative direction of acceleration axis)
XH	X High. Default value: 0 (0: X below THSI threshold; 1: X accel. exceeding THSE threshold along positive direction of acceleration axis)
XL	X Low. Default value: 0 (0: X below THSI threshold; 1: X accel. exceeding THSE threshold along negative direction of acceleration axis)

Direction detector source register

7.27 DD_ACK (3Ah)

Dummy register. If LIR bit in DD_CFG=1 allows the refresh of DD_SRC. Read data is not significant.

7.28 DD_THSI_L (3Ch)

THSI7	THSI6	THSI5	THSI4	THSI3	THSI2	THSI1	THSI0
-------	-------	-------	-------	-------	-------	-------	-------

THSI7, THSI0	Direction detection Internal Threshold LSB
--------------	--

7.29 DD_THSI_H (3Dh)

THSI15	THSI14	THSI13	THSI12	THSI11	THSI10	THSI9	THSI8
--------	--------	--------	--------	--------	--------	-------	-------

THSI15, THSI8	Direction detection Internal Threshold MSB
---------------	--

7.30 DD_THSE_L (3Eh)

THSE7	THSE6	THSE5	THSE4	THSE3	THSE2	THSE1	THSE0
-------	-------	-------	-------	-------	-------	-------	-------

THSE7, THSE0	Direction detection External Threshold LSB
--------------	--

7.31 DD_THSE_H (3Fh)

THSE15	THSE14	THSE13	THSE12	THSE11	THSE10	THSE9	THSE8
--------	--------	--------	--------	--------	--------	-------	-------

THSE15, THSE8	Direction detection External Threshold MSB
---------------	--

8 Package Information

In order to meet environmental requirements, ST offers these devices in ECOPACK® packages. These packages have a Lead-free second level interconnect. The category of second Level Interconnect is marked on the package and on the inner box label, in compliance with JEDEC Standard JESD97. The maximum ratings related to soldering conditions are also marked on the inner box label. ECOPACK is an ST trademark.

ECOPACK specifications are available at: www.st.com.

Figure 10. LGA-16 Mechanical Data & Package Dimensions

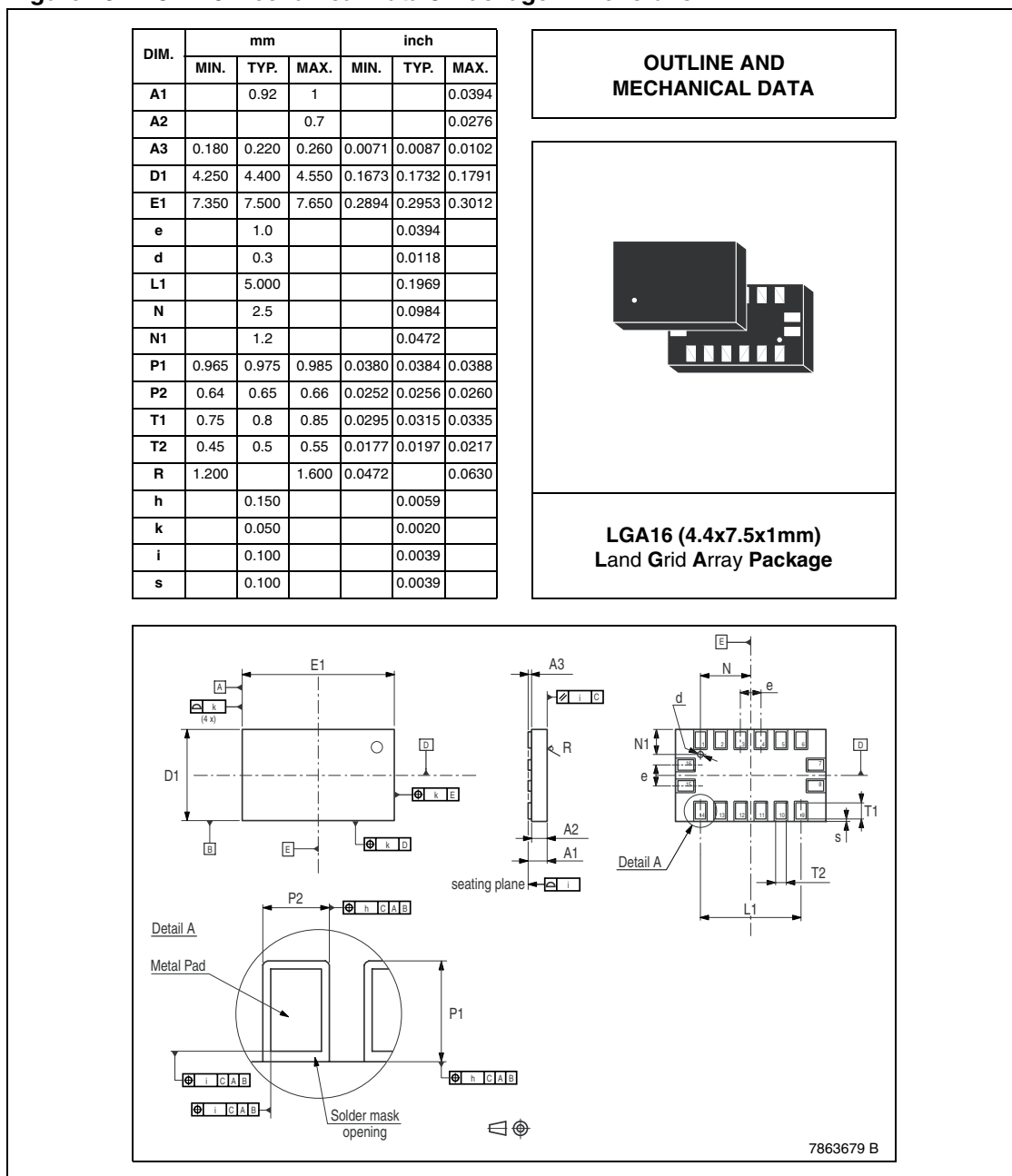

9 Revision history

Table 8. Document revision history

Date	Revision	Changes
15-Feb-2006	1	Initial release.

Please Read Carefully:

Information in this document is provided solely in connection with ST products. STMicroelectronics NV and its subsidiaries ("ST") reserve the right to make changes, corrections, modifications or improvements, to this document, and the products and services described herein at any time, without notice.

All ST products are sold pursuant to ST's terms and conditions of sale.

Purchasers are solely responsible for the choice, selection and use of the ST products and services described herein, and ST assumes no liability whatsoever relating to the choice, selection or use of the ST products and services described herein.

No license, express or implied, by estoppel or otherwise, to any intellectual property rights is granted under this document. If any part of this document refers to any third party products or services it shall not be deemed a license grant by ST for the use of such third party products or services, or any intellectual property contained therein or considered as a warranty covering the use in any manner whatsoever of such third party products or services or any intellectual property contained therein.

UNLESS OTHERWISE SET FORTH IN ST'S TERMS AND CONDITIONS OF SALE ST DISCLAIMS ANY EXPRESS OR IMPLIED WARRANTY WITH RESPECT TO THE USE AND/OR SALE OF ST PRODUCTS INCLUDING WITHOUT LIMITATION IMPLIED WARRANTIES OF MERCHANTABILITY, FITNESS FOR A PARTICULAR PURPOSE (AND THEIR EQUIVALENTS UNDER THE LAWS OF ANY JURISDICTION), OR INFRINGEMENT OF ANY PATENT, COPYRIGHT OR OTHER INTELLECTUAL PROPERTY RIGHT.

UNLESS EXPRESSLY APPROVED IN WRITING BY AN AUTHORIZED REPRESENTATIVE OF ST, ST PRODUCTS ARE NOT DESIGNED, AUTHORIZED OR WARRANTED FOR USE IN MILITARY, AIR CRAFT, SPACE, LIFE SAVING, OR LIFE SUSTAINING APPLICATIONS, NOR IN PRODUCTS OR SYSTEMS, WHERE FAILURE OR MALFUNCTION MAY RESULT IN PERSONAL INJURY, DEATH, OR SEVERE PROPERTY OR ENVIRONMENTAL DAMAGE.

Resale of ST products with provisions different from the statements and/or technical features set forth in this document shall immediately void any warranty granted by ST for the ST product or service described herein and shall not create or extend in any manner whatsoever, any liability of ST.

ST and the ST logo are trademarks or registered trademarks of ST in various countries.

Information in this document supersedes and replaces all information previously supplied.

The ST logo is a registered trademark of STMicroelectronics. All other names are the property of their respective owners.

© 2006 STMicroelectronics - All rights reserved

STMicroelectronics group of companies

Australia - Belgium - Brazil - Canada - China - Czech Republic - Finland - France - Germany - Hong Kong - India - Israel - Italy - Japan - Malaysia - Malta - Morocco - Singapore - Spain - Sweden - Switzerland - United Kingdom - United States of America

www.st.com