

PRM™ Regulator

FEATURES

- 48V input (36V to 75V), non-isolated ZVS buck-boost regulator
- 20V to 55V adjustable output range
- 400W output power in 1.1in² footprint
- 97.5% typical efficiency, at full load
- 1355 W/in³ (83 W/cm³) Power Density
- 4.01 Mhrs MTBF (MIL-HDBK-217Plus Parts Count)
- Pin selectable operating mode
 - Adaptive Loop
 - Remote Sense / Slave
- Full VICChip Package
 - 32.5mm x 22.0mm x 6.73mm

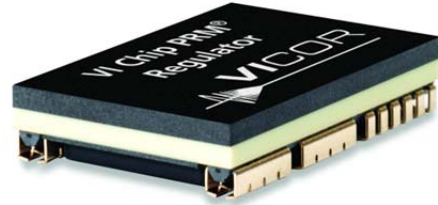

TYPICAL APPLICATIONS

- High Density Power Supply DC-DC rail outputs
- High Density ATE system DC-DC power
- Telecom NPU and ASIC core power
- Communications Systems
- Non-isolated and isolated power converters

PRODUCT RATINGS	
$V_{IN} = 36V \text{ to } 75V$	$P_{OUT} = 400W$
$V_{OUT} = 48V$ (20V to 55V Trim)	$I_{OUT} = 8.33A$

DESCRIPTION

The VICChip™ PRM™ Regulator is a high efficiency converter, operating from a 36 to 75 Vdc input to generate a regulated 20 to 55 Vdc output. The ZVS buck – boost topology enables high switching frequency (~1.03 MHz) operation with high conversion efficiency. High switching frequency reduces the size of reactive components enabling power density up to 1355 W/in³.

The Full VICChip package is compatible with standard pick-and-place and surface mount assembly processes with a planar thermal interface area and superior thermal conductivity.

In a Factorized Power Architecture™ system, the PRM and downstream VTM™ current multiplier minimize distribution and conversion losses in a high power solution, providing an isolated, regulated output voltage.

The PRM48A[x]480[y]400A00 has two selectable modes of regulation depending on the application requirements.

In Adaptive Loop operation, the PRM48A[x]480[y]400A00 utilizes a unique feed-forward scheme that enables precise regulation of an isolated POL voltage without the need for remote sensing and voltage feedback.

In Remote Sense operation, the internal regulation circuitry is disabled, and an external control loop and current sensor maintain regulation. This affords flexibility in the design of both voltage and current compensation loops to optimize performance in the end application.

TYPICAL APPLICATIONS

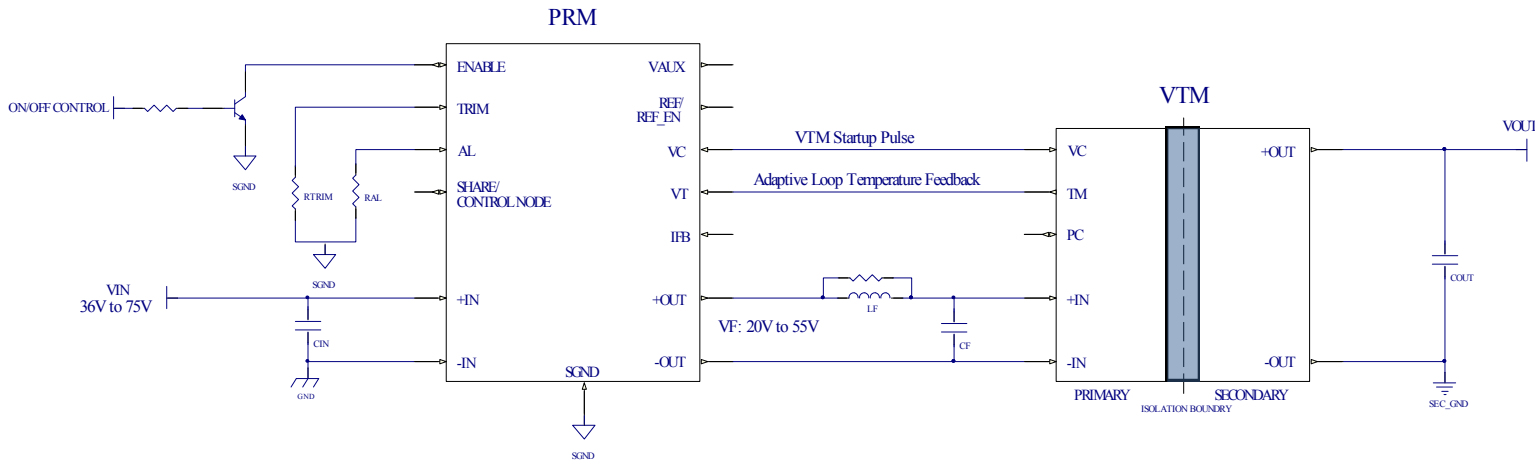

Typical Application: PRM48A[x]480[y]400A00 + VTM Adaptive Loop Configuration

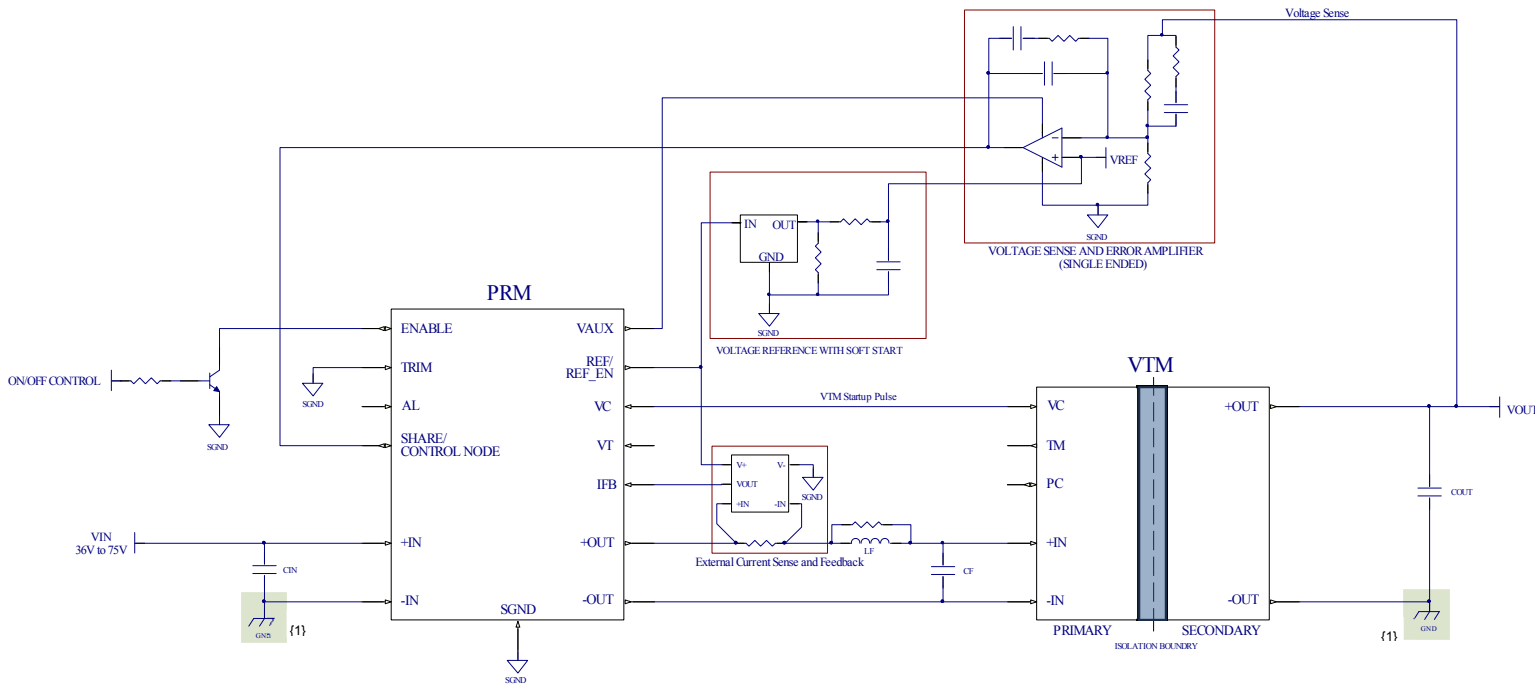

Typical Application: PRM48A[x]480[y]400A00 + VTM non-Isolated Remote Sense Configuration

{1} Non-Isolated Configuration: -Out connected to -In

PIN CONFIGURATION

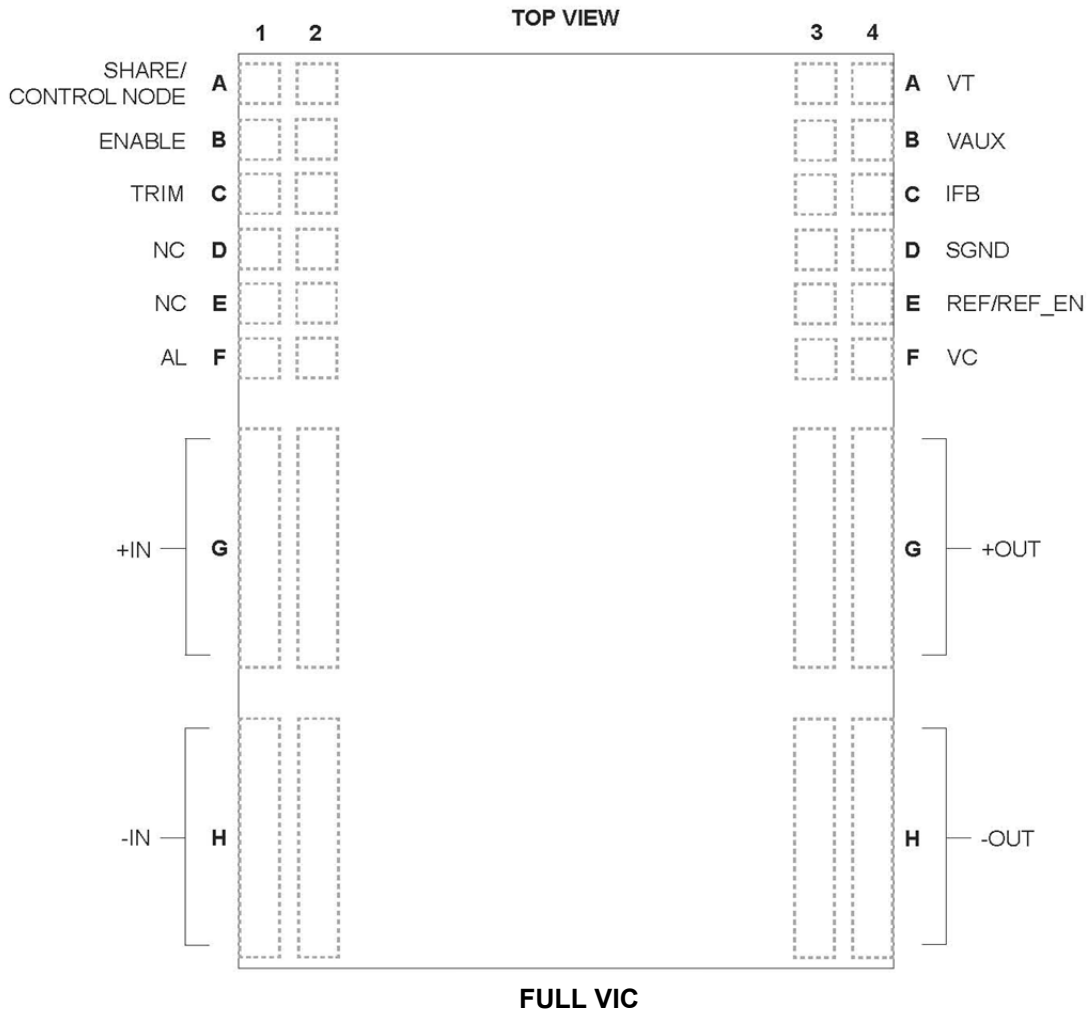

PIN DESCRIPTIONS

Pin Number	Signal Name	Type	Function
A1, A2	SHARE (adaptive loop / slave operation)	BIDIR	Parallel sharing control bus for master-slave configuration.
	CONTROL NODE (remote sense operation)	INPUT	Modulator control node input. Driven by external error amplifier in remote sense operation.
A3, A4	VT (adaptive loop operation)	INPUT	VTM TM input for temperature compensation. Leave disconnected for remote sense operation.
B1, B2	ENABLE	BIDIR	Enables power supply when allowed to float high. 5.0V during normal operation.
B3, B4	VAUX	OUTPUT	9.0V auxiliary bias voltage.
C1, C2	TRIM	INPUT	Selects operating mode. Adjusts output voltage in adaptive loop operation.
C3, C4	IFB (Remote Sense operation)	INPUT	Current sense input for current limit and overcurrent protection in remote sense operation. Leave disconnected for adaptive loop operation.
D1, D2	NC	n/a	Do not connect this pin.
D3, D4	SGND	INPUT	Signal ground, reference for analog controls. Kelvin connected internally to -IN and -OUT.
E1, E2	NC	n/a	Do not connect this pin.
E3, E4	REF (adaptive loop operation)	OUTPUT	Reference voltage for internal error amplifier in adaptive loop operation.
	REF_EN (remote sense operation)	OUTPUT	Powers and enables external control circuit voltage reference in remote sense operation.
F1, F2	AL (adaptive loop operation)	INPUT	Adaptive loop gain control. Sets the magnitude of the adaptive loop load line in adaptive loop operation. Leave disconnected for remote sense operation.
F3, F4	VC	OUTPUT	Bias voltage to power VTM module during startup
G1,G2	+IN	INPUT POWER	Positive input power terminal
G3,G4	+OUT	OUTPUT POWER	Positive output power terminal
H1,H2	-IN	INPUT POWER RETURN	Negative input power terminal. Connected internally to -OUT.
H3,H4	-OUT	OUTPUT POWER RETURN	Negative output power terminal. Connected internally to -IN.

PART ORDERING INFORMATION

PART ORDERING INFORMATION							
Device Type	Input Voltage Range	Package Type	Output Voltage x 10	Temperature Grade	Output Power	Revision	Version
PRM	48A	F	480	T	400	A	00
PRM = PRM	48A = 36V – 75V	F = Full VIC SMD T = Full VIC TH	480 = 48V	T = -40 to 125 °C M = -55 to 125 °C	400 = 400W	A	00 = AL / RS

STANDARD MODELS							
PART NUMBER	VIN	PACKAGE TYPE	VOUT	TEMPERATURE	POWER	VERSION	
PRM48A F 480 T 400A00	36V – 75V	Full VIC SMD	48V (20V to 55V)	-40 to 125 °C	400W	AL / RS (Pin Selectable)	
PRM48A F 480 M 400A00				-55 to 125 °C			
PRM48A T 480 T 400A00	36V – 75V	Full VIC TH	48V (20V to 55V)	-40 to 125 °C	400W	AL / RS (Pin Selectable)	
PRM48A T 480 M 400A00				-55 to 125 °C			

ABSOLUTE MAXIMUM RATINGS

The ABSOLUTE MAXIMUM ratings below are stress ratings only. Operation at or beyond these maximum ratings can cause permanent damage to device. Electrical specifications do not apply when operating beyond rated operating conditions. Operating beyond rated operating conditions for extended period of time may affect device reliability. All voltages are specified relative to SGND unless otherwise noted. Positive pin current represents current flowing out of the pin.

ABSOLUTE MAXIMUM RATINGS					
Parameter	Comments	Min	Max	Unit	
SHARE / CONTROL NODE		-0.3	10.5	V	
			+/- 10	mA	
ENABLE		-0.3	5.5	V	
			+/- 10	mA	
+IN to -IN	Continuous, non-Operating	-1	90	V	
	100ms, non-Operating		100	V	
VAUX		-0.5	10.5	V	
			+/- 100	mA	
SGND			+/- 100	mA	
IFB		-0.5	5.7	V	
REF / REF_EN		-0.3	3.6	V	
	Remote Sense Operation		10	mA	
	Adaptive Loop Operation		3.4	mA	
TRIM		-0.3	3.6	V	
AL		-0.3	3.6	V	
VT		-0.3	4.8	V	
VC to -OUT		-0.5	18	V	
			+/- 1.8	A	
+OUT to -OUT		-1	62	V	
Output Current			12.5	A	
Internal Operating Temperature	T Grade	-40	125	°C	
	M Grade	-55	125	°C	
Storage Temperature	T Grade	-40	125	°C	
	M Grade	-65	125	°C	

ELECTRICAL SPECIFICATIONS

ELECTRICAL CHARACTERISTICS

Specifications apply over all line and load conditions, and trim from 20 V to 55 V, unless otherwise noted;
 Boldface specifications apply over the temperature range of -40°C < T_{INT} < 125°C; All Other specifications are at T_{INT} = 25°C unless otherwise noted.

Attribute	Symbol	Conditions / Notes	Min	Typ	Max	Unit
POWER INPUT SPECIFICATION						
Input Voltage Range	V _{IN}	Continuous, operating	36	48	75	V
V _{IN} Slew Rate	dV _{IN} /dt	0 ≤ V _{IN} ≤ 75V	0.001		1000	V/ms
Initialization Voltage	V _{INIT}	Internal micro controller initialization voltage		10		V
Initialization Delay	t _{INIT}	From V _{IN} first crossing V _{INIT}	5.0	7.0	9.0	ms
No Load Power Dissipation	P _{NL}	ENABLE HIGH, V _{IN} = 48 V		2.4	3.5	W
Input Quiescent Current	I _{QC}	ENABLE LOW, V _{IN} = 48V		14.5	20	mA
Input Current	I _{IN,DC}	I _{OUT} = 8.33A, V _{IN} = 48 V, V _{OUT} = 48 V		8.6	8.8	A
Input Capacitance (Internal)	C _{IN,INT}	Effective value, V _{IN} = 48 V (see Fig. 13)		6		μF
Input Capacitance (Internal) ESR	R _{CIN}	Effective value, V _{IN} = 48 V		1.5		mΩ
POWER OUTPUT SPECIFICATION						
Output Current	I _{OUT}	Standalone and Master operation, see Figure 1, SOA			8.33	A
Output Power	P _{OUT}	Standalone and Master operation, see Figure 1, SOA			400	W
Switching Frequency	F _{SW}	V _{IN} = 48V, V _{OUT} = 48V, I _{OUT} = 4.17A, T _{INT} = 25°C	0.935	1.03	1.065	MHz
		Over line, load, trim and temperature, exclusive of burst mode	0.70		1.065	MHz
Turn-ON Delay	t _{ON}	From V _{IN} first crossing V _{IN_UVLOH_SUPV} to ENABLE high; t _{INIT} expired		20		μs
		From ENABLE released to ENABLE high, V _{IN} applied, t _{OFF} and t _{INIT} expired				
Startup Sequence Timeout	t _{STARTUP_SEQ}	From ENABLE high to startup sequence complete		17		ms
Efficiency Ambient	η _{AMB}	V _{IN} = 48V, V _{OUT} = 48V, I _{OUT} = 8.33A, T _{INT} = 25°C	96.5	97.5		%
		V _{IN} = 48V, V _{OUT} = 48V, I _{OUT} = 4.17A, T _{INT} = 25°C	95.8	96.75		%
		V _{IN} = 36V to 75V, V _{OUT} = 48V, I _{OUT} = 8.33A, T _{INT} = 25°C	96.0			%
		V _{IN} = 36V to 75V, I _{OUT} = 8.33A, T _{INT} = 25°C, over trim	92.0			%
Efficiency Hot	η _{HOT}	V _{IN} = 48V, V _{OUT} = 48V, I _{OUT} = 8.33A, T _{INT} = 100°C	96.3	97.3		%
		V _{IN} = 48V, V _{OUT} = 48V, I _{OUT} = 4.17A, T _{INT} = 100°C	95.8	96.8		%
		V _{IN} = 36V to 75V, V _{OUT} = 48V, I _{OUT} = 8.33A, T _{INT} = 100°C	95.0			%
		V _{IN} = 36V to 75V, I _{OUT} = 8.33A, T _{INT} = 100°C, over trim	91.0			%
Efficiency Over Temperature	η	>50% load and V _{OUT} = 48 V; over temperature	95.0			%
		>50% load; over temperature and trim	90.0			%
Output Discharge current	I _{OD}	Average Value		0.5		mA
Output Voltage Ripple	V _{OUT_PP}	V _{IN} = 48 V, V _{OUT} = 48 V, I _{OUT} = 8.33A, C _{OUT_EXT} = 0 F, 20 MHz BW		650	1000	mV
Output Inductance (Parasitic)	L _{OUT_PAR}	Frequency @ 1.00 MHz, Simulated J-Lead model		1.9		nH
Output Capacitance (Internal)	C _{OUT_INT}	Effective value, V _{OUT} = 48 V (see Fig. 13)		6		μF
Output Capacitance (Internal) ESR	R _{COUT}	Effective value, V _{OUT} = 48 V		1.5		mΩ

ELECTRICAL CHARACTERISTICS

Specifications apply over all line and load conditions, and trim from 20 V to 55 V, unless otherwise noted; **Boldface specifications apply over the temperature range of -40°C < T_{INT} < 125°C; All Other specifications are at T_{INT} = 25°C unless otherwise noted.**

POWER OUTPUT SPECIFICATIONS: ADAPTIVE LOOP OPERATION

Output Voltage Setpoint	V _{OUT_SET}	No load, trim Inactive, Adaptive Loop load line inactive	47.04	48	48.96	V
Output Voltage Trim Range	V _{OUT}		20		55	V
Output Voltage Rise Time	t _{RISE_VOUT}	From soft start initiated to output voltage settled	1.7	1.8	1.9	ms
Output Voltage Load Regulation	V _{OUT_REG_LOAD}	Adaptive Loop load line inactive		0.02	0.2	%
Output Voltage Line Regulation	V _{OUT_REG_LINE}	Adaptive Loop load line inactive		0.02	0.2	%
Total Regulation Error	V _{OUT_REG_TOTAL}	PRM Output Voltage, Adaptive Loop load line inactive			0.2	%
Total AL Regulation Error	V _{OUT_REG_AL}	VTM output voltage, total Adaptive Loop regulation, V _{OUT} = 48 V, trim inactive		1	3	%
		VTM output voltage, total Adaptive Loop regulation, trim active, exclusive of external resistor tolerances			5	%
Output Current Limit	I _{LIMIT}	V _{IN} = 48V, V _{OUT} = 48V, T _{INT} = 25°C, Constant current limit after supervisory limit detection time t _{LIM_SUPV}	8.5	10.0	12.3	A
		Over line, load, trim and temperature	8.0		12.5	A
Load Capacitance (Electrolytic)	C _{LOAD_ALEL}	0.1Ω ≤ ESR ≤ 1.0Ω, See Figure 31, total capacitance (C _{LOAD_ALEL} + C _{LOAD_CER}) ≤ 47μF			47	μF
Load Capacitance (Ceramic)	C _{LOAD_CER}	2mΩ ≤ ESR ≤ 200mΩ, See Figure 31			25	μF
Load Transient Voltage Deviation	V _{TRANS}	10% ↔ 100% load step, 10 A/μsec, 0 uF Cout, deviation from initial setpoint			4.8	V
Load Transient Recovery Time	t _{TRANS}	10% to 100% load step, 10 A/μsec, 0 uF Cout, Recovery to 90% of final value, Adaptive Loop load line inactive		100		μs
		10% to 100% load step, 10 A/μsec, 0 uF Cout, Recovery to 90% of final value, Adaptive Loop load line active, VAL=1.25V		500		μs

POWER OUTPUT SPECIFICATIONS: SLAVE OPERATION

Rated Current Within an Array	I _{OUT_ARRAY}	Slave operation within an array, up to 5°C case temperature differential, master-slave configuration			6.67	A
		Slave operation within an array, up to 30°C case temperature differential, master-slave configuration			5.83	A
Rated Power Within an Array	P _{OUT_ARRAY}	Slave operation within an array, up to 5°C case temperature differential, master-slave configuration			320	W
		Slave operation within an array, up to 30°C case temperature differential, master-slave configuration			280	W
Current Sharing Difference (Master to Slave)	I _{OUT_SHARE_MS}	Equal input, and output voltage at full load; V _{IN} = 48 V, V _{OUT} = 48 V			15	%
		Equal input and output voltage at full load; Over line and trim, with 25°C ≤ T _C ≤ 100°C and ≤ 5°C part-part temp mismatch			15	%
		Equal input, and output voltage at full load; Over line and trim, with 25°C ≤ T _C ≤ 100°C and ≤ 30°C part-part temp. mismatch			20	%
Current Sharing Difference (Slave to Slave)	I _{OUT_SHARE_SS}	Equal input, output, and SHARE voltage at full load; V _{IN} = 48 V, V _{OUT} = 48 V			5	%
		Equal input, output and SHARE voltage at full load; Over line and trim, with 25°C ≤ T _C ≤ 100°C and ≤ 5°C part-part temp mismatch			10	%
		Equal input, output, and SHARE voltage at full load; Over line and trim, with 25°C ≤ T _C ≤ 100°C and ≤ 30°C part-part temp. mismatch			15	%
Maximum Array Size	N _{PRMS_PARALLEL}	Maximum number of parallel devices, master-slave configuration			5	PRMs

POWER OUTPUT SPECIFICATIONS: REMOTE SENSE OPERATION

Output Voltage Range	V _{OUT}		20		55	V
Rated Current Within an Array	I _{OUT_ARRAY}	Remote Sense operation within an array, up to 5°C case temperature differential			7.5	A
		Remote Sense operation within an array, up to 30°C case temperature differential			5.8	A
Rated Power Within an Array	P _{OUT_ARRAY}	Remote Sense operation within an array, up to 5°C case temperature differential			360	W
		Remote Sense operation within an array, up to 30°C case temperature differential			280	W
Current Sharing Difference	I _{OUT_SHARE_RS}	Equal input, output, and CONTROL NODE voltage at full load; V _{IN} = 48 V, V _{OUT} = 48 V			5	%
		Equal input, output and CONTROL NODE voltage at full load; Over line and trim, with 25°C ≤ T _C ≤ 100°C and ≤ 5°C part-part temp mismatch			10	%
		Equal input, output, and CONTROL NODE voltage at full load; Over line and trim, with 25°C ≤ T _C ≤ 100°C and ≤ 30°C part-part temp. mismatch (worst case)			15	%
Maximum Array Size	N _{PRMS_PARALLEL}	Maximum number of parallel devices, Remote Sense configuration, CONTROL NODE externally driven			10	PRMs

ELECTRICAL CHARACTERISTICS

Specifications apply over all line and load conditions, and trim from 20 V to 55 V, unless otherwise noted;
Boldface specifications apply over the temperature range of -40°C < T_{INT} < 125°C; All Other specifications are at T_{INT} = 25°C unless otherwise noted.

POWERTRAIN PROTECTIONS

Input Undervoltage Turn-ON	V _{IN_UVLO+}			30.9	33.0	V
Input Undervoltage Turn-OFF	V _{IN_UVLO-}	Instantaneous powertrain shutdown, detected after t _{BLNK}	26.0	28.8		V
Input Undervoltage Hysteresis	V _{UVLO_HYST}	(V _{IN_UVLO+}) - (V _{IN_UVLO-})	1.9	2.2	2.4	V
Input Overvoltage Turn-ON	V _{IN_OVLO+}		79.6	82.9		V
Input Overvoltage Turn-OFF	V _{IN_OVLO-}	Instantaneous powertrain shutdown, detected after t _{BLNK}		84.6	88.8	V
Input Overvoltage Hysteresis	V _{OVLO_HYST}	(V _{IN_OVLO+}) - (V _{IN_OVLO-})	1.6	2.0	2.4	V
Output Overvoltage Threshold	V _{OUT_OVP+}	Instantaneous powertrain shutdown, detected after t _{BLNK}	56.0	58.3	60.1	V
Minimum Current Limited Vout	V _{OUT_UVP}				12	V
Overtemperature Shutdown Setpoint	T _{INT_OTP}	Instantaneous powertrain shutdown, detected after t _{BLNK}	125			°C
Output Power Limit	P _{PROT}		400			W
Short Circuit Vout Threshold	V _{SC_VOUT}			8.8		V
Short Circuit Vout Recovery Threshold	V _{SC_VOUTR}			9.5		V
Short Circuit CONTROL NODE Threshold	V _{SC_VCN}			7.2		V
Short Circuit CONTROL NODE Recovery Threshold	V _{SC_VCN}			6.9		V
Short Circuit Timeout	t _{SC}	Short circuit fault detected after V _{SC_VOUT} and V _{SC_VCN} thresholds persist for this time		5		ms
Short Circuit Recovery Time	t _{SCR}	Excludes t _{OFF}		75		ms
Overcurrent (IFB), and Input Over/Undervoltage Blanking Time	t _{BLNK}		50	120	150	µs
Overtemperature, Output Overvoltage and ENABLE Shutdown Response Time (Hardware)	t _{PROT}			2		µs

POWERTRAIN SUPERVISORY LIMITS

Input Undervoltage Turn-ON (Supervisory)	V _{IN_UVLO+_SUPV}	Powertrain shutdown, after supervisory detection t _{LIM_SUPV}		33.8	34.9	V
Input Undervoltage Turn-OFF (Supervisory)	V _{IN_UVLO-_SUPV}	Powertrain shutdown, after supervisory detection t _{LIM_SUPV}	30.5	31.8		V
Input Undervoltage Hysteresis (Supervisory)	V _{UVLO_HYST_SUPV}	(V _{IN_UVLO+_SUPV}) - (V _{IN_UVLO-_SUPV})	1.6	2.0	2.1	V
Input Overvoltage Turn-ON (Supervisory)	V _{IN_OVLO+_SUPV}	Powertrain shutdown after supervisory detection t _{LIM_SUPV}	75.6	78.8		V
Input Overvoltage Turn-OFF (Supervisory)	V _{IN_OVLO-_SUPV}	Powertrain shutdown after supervisory detection t _{LIM_SUPV}		80.3	82.7	V
Input Overvoltage Hysteresis (Supervisory)	V _{OVLO_HYST_SUPV}	(V _{IN_OVLO+_SUPV}) - (V _{IN_OVLO-_SUPV})	1.2	1.5	1.8	V
Undertemperature Shutdown Setpoint (Supervisory)	T _{INT_UTP}	T Grade			-40	°C
		M Grade			-55	°C
Supervisory Limit Response Time	t _{LIM_SUPV}				150	µs

SIGNAL SPECIFICATIONS

Specifications apply over all line and load conditions, $T_{INT} = 25\text{ }^{\circ}\text{C}$ and output voltage from 20V to 55V, unless otherwise noted. **Boldface specifications apply over the temperature range of $-40\text{ }^{\circ}\text{C} < T_{INT} < 125\text{ }^{\circ}\text{C}$ (T-grade).**

ENABLE								
<ul style="list-style-type: none"> The ENABLE pin enables and disables the PRM In PRM array configurations, ENABLE pins should be connected in order to synchronize start up ENABLE is 5.0V with 1.8mA source capability during normal operation 								
Signal Type	State	Attribute	Symbol	Conditions / Notes	Min	Typ	Max	Unit
Analog Output	Regular Operation	ENABLE voltage	V_{ENABLE}		4.7	5.0	5.3	V
		ENABLE available current	I_{ENABLE_OP}		1.8			mA
	Start up	ENABLE source current	I_{ENABLE_EN}	After t_{OFF}		90		μA
		Minimum time to start	t_{OFF}		13.5	15	16.5	ms
Digital Input / Output	Start up	ENABLE enable threshold	V_{ENABLE_EN}			2.5	3.2	V
	Standby	ENABLE disable threshold	V_{ENABLE_DIS}		0.97	2.4		V
		ENABLE resistance (external)	R_{ENABLE_EXT}	Resistance to SGND required to disable the PRM				235
Digital Output	Fault	ENABLE sink current to SGND	I_{ENABLE_FAULT}	ENABLE voltage 1 V or above			4	mA

VAUX: AUXILIARY VOLTAGE SOURCE									
<ul style="list-style-type: none"> Intended to power auxiliary circuits 9.0V during normal operation with 5mA source capability 									
Signal Type	State	Attribute	Symbol	Conditions / Notes	Min	Typ	Max	Unit	
Analog Output	Regular Operation	VAUX Voltage	V_{VAUX}		8.6	9.0	9.5	V	
		VAUX Available Current	I_{VAUX}		5			mA	
		VAUX Voltage Ripple	V_{VAUX_PP}	$I_{out} = 0\text{A}$, $C_{VAUX_EXT} = 0$. Maximum specification includes powertrain operation in burst mode.			100	400	mV
	Transition	VAUX Capacitance (External)	C_{VAUX_EXT}					0.04	μF
		VAUX Fault Response Time	t_{FR_VAUX}	From fault recognition to VAUX = 1.5 V			30		μs

VC: VTM CONTROL								
<ul style="list-style-type: none"> Pulsed voltage source used to power and synchronize downstream VTM during start up 14 V, 10 ms typical voltage pulse 								
Signal Type	State	Attribute	Symbol	Conditions / Notes	Min	Typ	Max	Unit
Analog Output	Start up	VC Voltage	V_{VC_START}	Connected to VTM VC or equivalent, $I_{VC} = 115\text{mA}$, $C_{VC} = 3.2\mu\text{F}$	13	14	18	V
		VC Available Current	I_{VC_START}	$V_C = 14\text{V}$, $V_{IN} > 20\text{V}$	200			mA
		VC duration	t_{VC}		7	10	16	ms
		VC Slew Rate	dV_C/dt	Connected to VTM or equivalent, $I_{VC} = 115\text{mA}$, $C_{VC} = 3.2\mu\text{F}$.02		.25	$\text{V}/\mu\text{s}$
		ENABLE to VC delay	t_{ENABLE_VC}				20	

SGND: SIGNAL GROUND

- All control signals must be referenced to this pin, with the exception of VC
- SGND is internally connected to –IN and –OUT

Signal Type	State	Attribute	Symbol	Conditions / Notes	Min	Typ	Max	Unit
Analog Input / Output	Any	Maximum Allowable Current	I _{SGND}		-100		100	mA

TRIM

- TRIM is used to select operating mode and trim the output voltage in Adaptive Loop operation
- Internal pullup to V_{CC_INT} through 10kΩ resistor
- When pulled below 0.45V during power up, Remote Sense / Slave operation is selected
- When allowed to pull up above 0.55 during power up, Adaptive Loop operation is selected
- Operating mode is latched during power up and cannot be changed unless input power is cycled

Signal Type	State	Attribute	Symbol	Conditions / Notes	Min	Typ	Max	Unit
Analog Input	Normal Operation	Internally generated VCC	V _{CC_INT}		3.20	3.28	3.36	V
		Internal Pullup Resistance to V _{CC_INT}	R _{TRIM_INT}	0.5% tolerance resistor	9.83	10	10.18	kΩ
	Mode Detect	Mode Detection Delay	t _{MODE_DETECT}	From ENABLE high to mode detected, after V _{IN} first applied	100	140	200	μs
		Remote Sense Enable Threshold	V _{RS_MODE_EN}	Pull below this value during application of power to enable Remote Sense / Slave operation			0.45	V
		Remote Sense Disable Threshold	V _{RS_MODE_DIS}	Pull above this value during application of power to enable Adaptive Loop operation	0.55			V

TRIM (ADAPTIVE LOOP OPERATION ONLY)

- Provides dynamic trim control over the PRM output voltage in Adaptive Loop operation
- Sampled prior to every start up to detect if trim is active or inactive
- Output voltage is equal to 20 times the voltage at the TRIM pin when applied TRIM voltage is within the active range
- Trim state is latched during normal operation and cannot be changed until start up is initiated

Signal Type	State	Attribute	Symbol	Conditions / Notes	Min	Typ	Max	Unit	
Analog Input	Start up	Trim Enable Threshold	V _{TRIM_EN}	Pull below this value during start up to enable trim control			3.10	V	
		Trim Disable Threshold	V _{TRIM_DIS}	Pull above this value during start up to disable trim control	3.20			V	
		Minimum Trim Disable Resistance	R _{TRIM_DIS_MIN}	Minimum TRIM resistance required to disable trim	10			MΩ	
		Trim Capacitance (External)	C _{TRIM_EXT}					100	pF
		Trim Sample Delay	t _{ENABLE_TRIM}	From ENABLE high to TRIM sampled	100	140	200	μs	
	Normal Operation	TRIM Pin Analog Range	V _{TRIM_RANGE}	See Figure 26	1.00		2.75		
		TRIM Gain	G _{TRIM}	V _{OUT} / V _{TRIM} , V _{TRIM} applied within active range		20		V/V	
		Trim Accuracy	% _{ACC_TRIM}	V _{out} accuracy, exclusive of external resistor tolerance		0.5	2	%	
		V _{OUT} referred trim resolution	V _{OUT_RES}			200		mV	
		Trim latency	t _{TRIM_LAT}		60	120	240	μs	
		Trim Bandwidth	BW _{TRIM}	-3dB point		1.2		kHz	

AL: ADAPTIVE LOOP (ADAPTIVE LOOP OPERATION ONLY)

- Provides Adaptive Loop load line programming in Adaptive Loop operation
- Internal pullup to V_{CC_INT} through 10kΩ resistor
- Sampled prior to every start up to detect if Adaptive Loop load line is active or inactive
- Leave open to disable Adaptive Loop load line
- Not used in Remote Sense operation

Signal Type	State	Attribute	Symbol	Conditions / Notes	Min	Typ	Max	Unit	
Analog Input	Start up	AL Enable Threshold	V_{AL_EN}	Pull below this value during start up to enable AL load line			3.10	V	
		AL Disable Threshold	V_{AL_DIS}	Pull above this value to disable AL load line	3.20			V	
		Minimum AL Disable Resistance	$R_{AL_DIS_MIN}$	Minimum AL resistance required to disable AL load line	10			MΩ	
		AL Capacitance (External)	C_{AL_EXT}					100	pF
		AL Sample Delay	t_{ENABLE_AL}	From ENABLE high to AL sampled	100	140	200		μs
	Normal Operation	Internally generated VCC	V_{CC_INT}			3.20	3.28	3.36	V
		Internal Pullup Resistance to V_{CC_INT}	R_{AL_INT}	0.5 % tolerance resistor		9.83	10	10.18	kΩ
		AL Pin Analog Range	V_{AL_RANGE}			0		3.10	V
		AL Gain	G_{AL}	Positive correction slope, VT inactive			0.5		Ω/V
		AL Load Line Accuracy	$\%_{ACC_LL_AL}$	Full load slope accuracy exclusive of external resistor tolerance			0.5	2	%
		AL load line resolution	LL_{AL_RES}				3		mΩ
		Maximum output referred compensation	$V_{OUT_AL_MAX}$	Maximum increase from no load setpoint, $V_{OUT} \leq 55V$				5	V
		AL Latency	t_{AL_LAT}		60	120	240		μs
AL Bandwidth	BW_{AL}	-3dB point			1.2		kHz		

VT: VTM TEMPERATURE (ADAPTIVE LOOP OPERATION ONLY)

- VTM temperature compensation for Adaptive Loop regulation
- Adjusts the slope of the Adaptive Loop load line to account for changes in VTM output resistance over temperature
- Connect to TM pin of compatible downstream VTM to enable temperature compensation
- Leave disconnected to disable temperature compensation

Signal Type	State	Attribute	Symbol	Conditions / Notes	Min	Typ	Max	Unit	
Analog Input	Normal Operation	Internal Resistance to SGND	R_{VT_INT}			80		kΩ	
		VT Enable Threshold	V_{VT_EN}				2.1	V	
		VT Disable Threshold	V_{VT_DIS}	Pull below this value to disable VT temperature compensation	1.9			V	
		VT Disable Default Temperature	T_{VT_DIS}	Default AL temperature setting when VT disabled		25		°C	
		VT analog range	V_{VT_OP}		2.18		3.98	V	
		VT Temperature Coefficient	TC_{VT}	VT within active range, referenced to 2.98V			30		%/V
			TC_{VT}	VTM TM voltage applied, .01V/°K, referenced to 25C			0.3		%/C
		VT Resolution	TC_{VT_RES}	VTM TM voltage applied, .01V/°K			0.4		°C
		VT Latency	t_{VT_LAT}		60	120	240		μs
Bandwidth	BW_{VT}	-3dB point			1.5		kHz		

REF / REF_EN

REF: REFERENCE (ADAPTIVE LOOP OPERATION ONLY)

- Functions as REF pin in Adaptive Loop operation
- REF represents the internal voltage reference for the voltage control circuit
- V_{OUT} approximately equal to 20 times REF voltage

Signal Type	State	Attribute	Symbol	Conditions / Notes	Min	Typ	Max	Unit	
Analog Output	Regular Operation	REF Voltage	V_{REF}	$V_{OUT} = 48V$, Trim inactive		2.4		V	
		REF to V_{OUT} Scale Factor	G_{REF_VOUT}	V_{OUT} / V_{REF}		20		V/V	
		REF Resistance (External)	R_{REF_EXT}			10		MΩ	
		REF Capacitance (External)	C_{REF_EXT}					200	pF
		REF Voltage Ripple	V_{REF_PP}	includes burst mode, 20MHz BW			100		mV
	Transition	ENABLE to REF Delay	t_{ENABLE_REF}	ENABLE low to REF low			120		μs
		VAUX to REF Delay	t_{VAUX_REF}	VAUX = 8.1 V to REF soft start ramp initiated			1		ms

REF_EN: REFERENCE ENABLE (REMOTE SENSE AND SLAVE OPERATION ONLY)

- Functions as REF_EN pin in Remote Sense and Slave operation
- REF_EN signals successful start up and powertrain ready to operate
- Intended to power and enable the external feedback circuit reference in Remote Sense operation
- 3.25V, 4mA regulated voltage source

Signal Type	State	Attribute	Symbol	Conditions / Notes	Min	Typ	Max	Unit	
Analog Output	Regular Operation	REF_EN Voltage	V_{REF_EN}	REF_EN unloaded	2.72	3.25	3.37	V	
		REF_EN Source Impedance	$R_{OUT_REF_EN}$			50	100	Ω	
		REF_EN Available Current	I_{REF_EN}			4			mA
		REF_EN Capacitance (External)	$C_{REF_EN_EXT}$					0.1	μF
		REF_EN Voltage Ripple	$V_{REF_EN_PP}$	includes burst mode, 20MHz BW			25		mV
	Transition	ENABLE to REF_EN Delay	$t_{ENABLE_REF_EN}$	ENABLE low to REF_EN low			1		ms
		VAUX to REF_EN Delay	$t_{VAUX_REF_EN}$	VAUX = 8.1 V to REF_EN high			1		ms

SHARE / CONTROL NODE

SHARE (ADAPTIVE LOOP AND SLAVE OPERATION ONLY)

- Functions as SHARE pin in master slave array configuration
- Current share bus for array operation (master/slave scheme)
- Sources current and provides SHARE signal in master operation
- Sinks constant current when externally driven in active range (Slave operation)

Signal Type	State	Attribute	Symbol	Conditions / Notes	Min	Typ	Max	Unit
Analog Output	Standalone / Master Operation	SHARE Voltage Active Range	V_{SHARE}		0.79		7.40	V
		SHARE Available Current	I_{SHARE}	$V_{SHARE} > 0.79V$	2.5			mA
		SHARE Resistance to SGND	R_{SHARE}			93.3		k Ω
Analog Input	Slave Operation	SHARE Sink Current	I_{SHARE_SINK}	$V_{SHARE} > 0.79V$	0.25	0.50	0.75	mA

CONTROL NODE (REMOTE SENSE OPERATION ONLY)

- Functions as CONTROL NODE pin in Remote Sense operation
- Modulator control node voltage sets power train timing
- Driven by external error amplifier in Remote Sense operation
- Sinks constant current when externally driven in active range
- Sources current, and clamps voltage to 0.79V when pulled below active range

Signal Type	State	Attribute	Symbol	Conditions / Notes	Min	Typ	Max	Unit
Analog Input	Regular Operation	CONTROL NODE Voltage Active Range	V_{CN}		0.79		7.40	V
		CONTROL NODE Source Current	I_{CN_LOW}	$V_{CN} < 0.79V$			2.5	mA
		CONTROL NODE Sink Current	I_{CN_SINK}	$V_{CN} > 0.79V$	0.25	0.50	0.75	mA
		CONTROL NODE Resistance to SGND	R_{CN}			93.3		k Ω

IFB: CURRENT FEEDBACK (REMOTE SENSE OPERATION ONLY)

- Functions as IFB pin in Remote Sense operation
- A voltage proportional to the PRM output current must be supplied externally to the IFB pin in order for the device to properly protect overcurrent events and to enable output current limit (clamp)
- Overcurrent protection trip will cause instantaneous powertrain shutdown, detected after t_{BLNK}
- Not used for Adaptive Loop operation

Signal Type	State	Attribute	Symbol	Conditions / Notes	Min	Typ	Max	Unit
Analog Input	Regular Operation	Current Limit (clamp) Threshold	V_{IFB_IL}	$V_{IN} = 48V V; V_{OUT} = 48V T_{INT} = 25^{\circ}C$	1.90	2.00	2.10	V
				Over Line, Trim, and Temperature	1.85		2.15	V
		Overcurrent Protection Threshold	V_{IFB_OC}	Not Production Tested; Guaranteed by Design; $T_{INT} = 25^{\circ}C$	2.58	2.69	2.80	V
				Not Production Tested; Guaranteed by Design; Over Line, Trim, and Temperature	2.09		2.17	V
		IFB Input Impedance	R_{IFB}		2.09	2.13	2.17	k Ω
Current Limit Bandwidth	BW_{IL}			2.0		kHz		

NC: NO CONNECT

- Reserved for factory use only
- No connections should be made to these pins

FUNCTIONAL BLOCK DIAGRAM

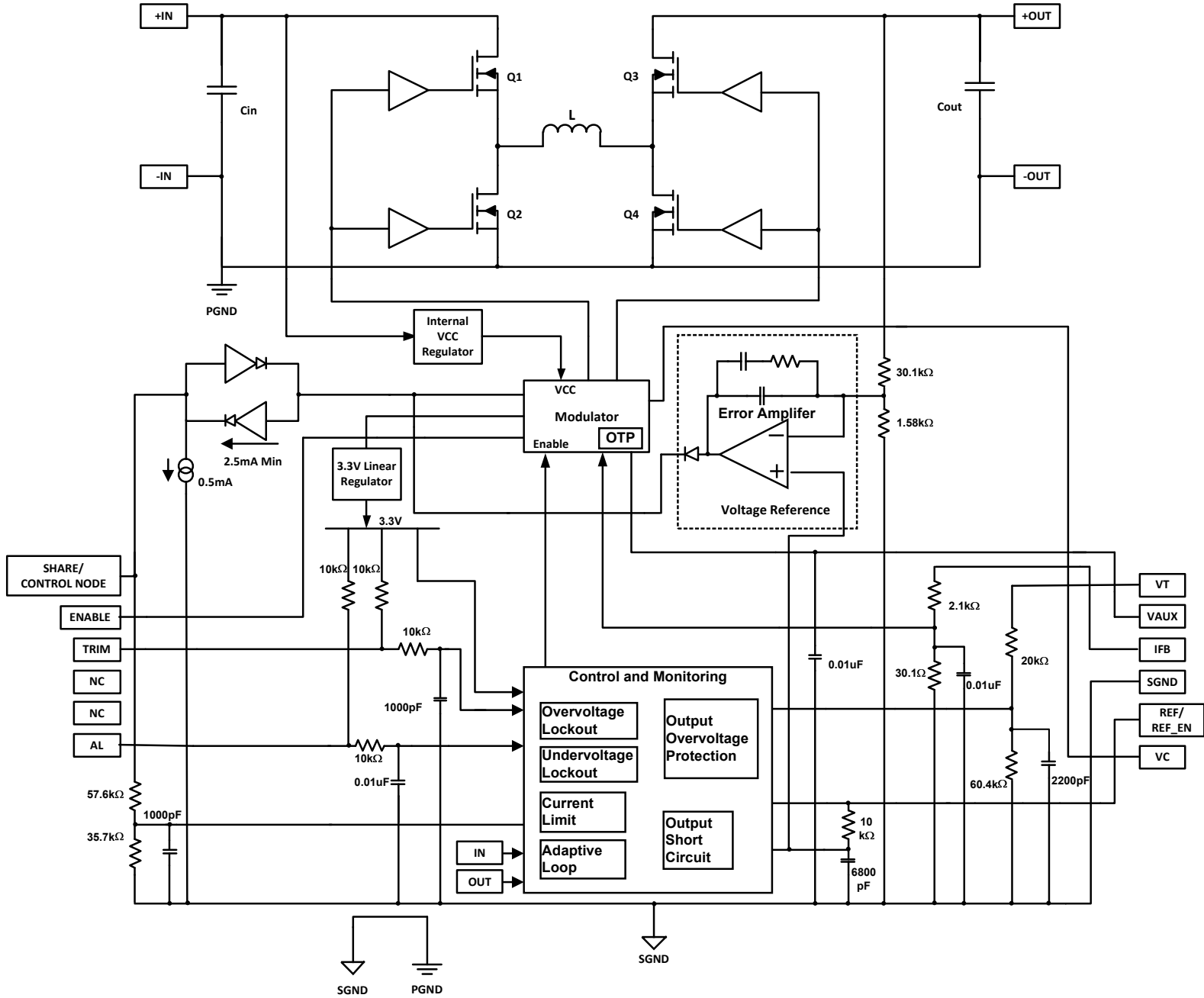

HIGH LEVEL FUNCTIONAL STATE DIAGRAM

Conditions that cause state transitions are shown along arrows. Sub-sequence activities listed inside the state bubbles.

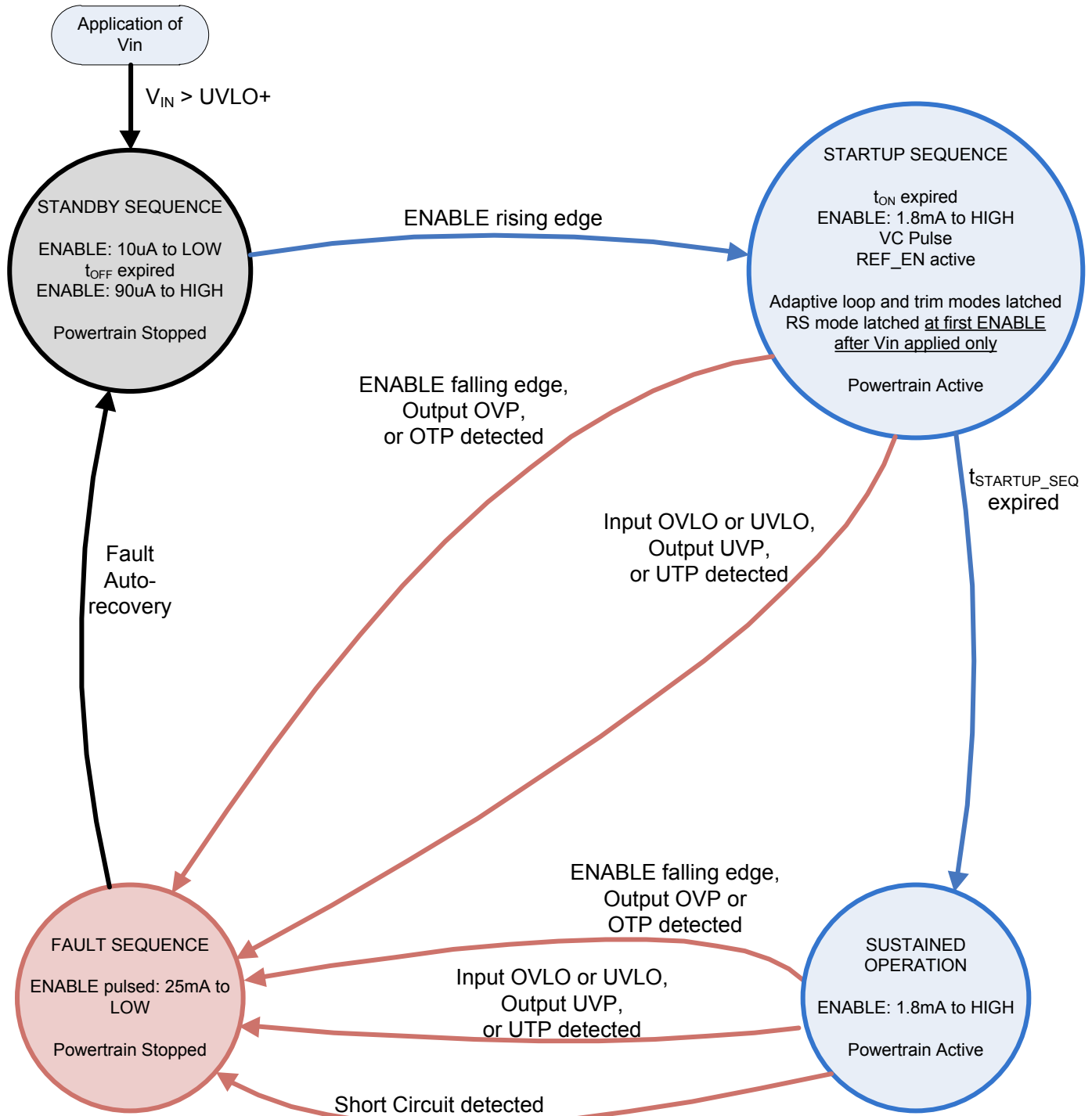

TIMING DIAGRAMS (Adaptive Loop operation page 1)

Module Inputs are shown in blue; Module Outputs are shown in brown.

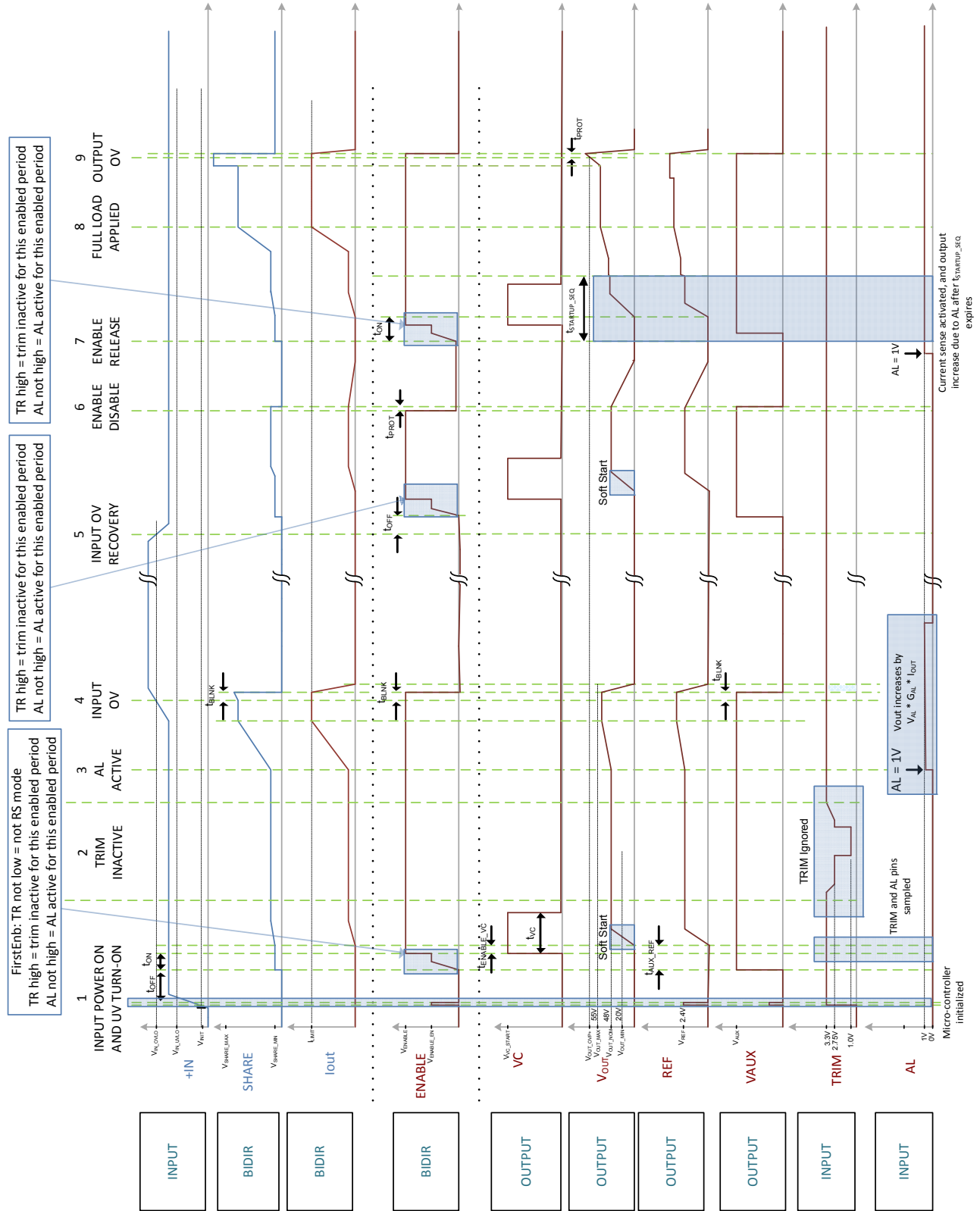

TIMING DIAGRAMS (Adaptive Loop operation page 2)

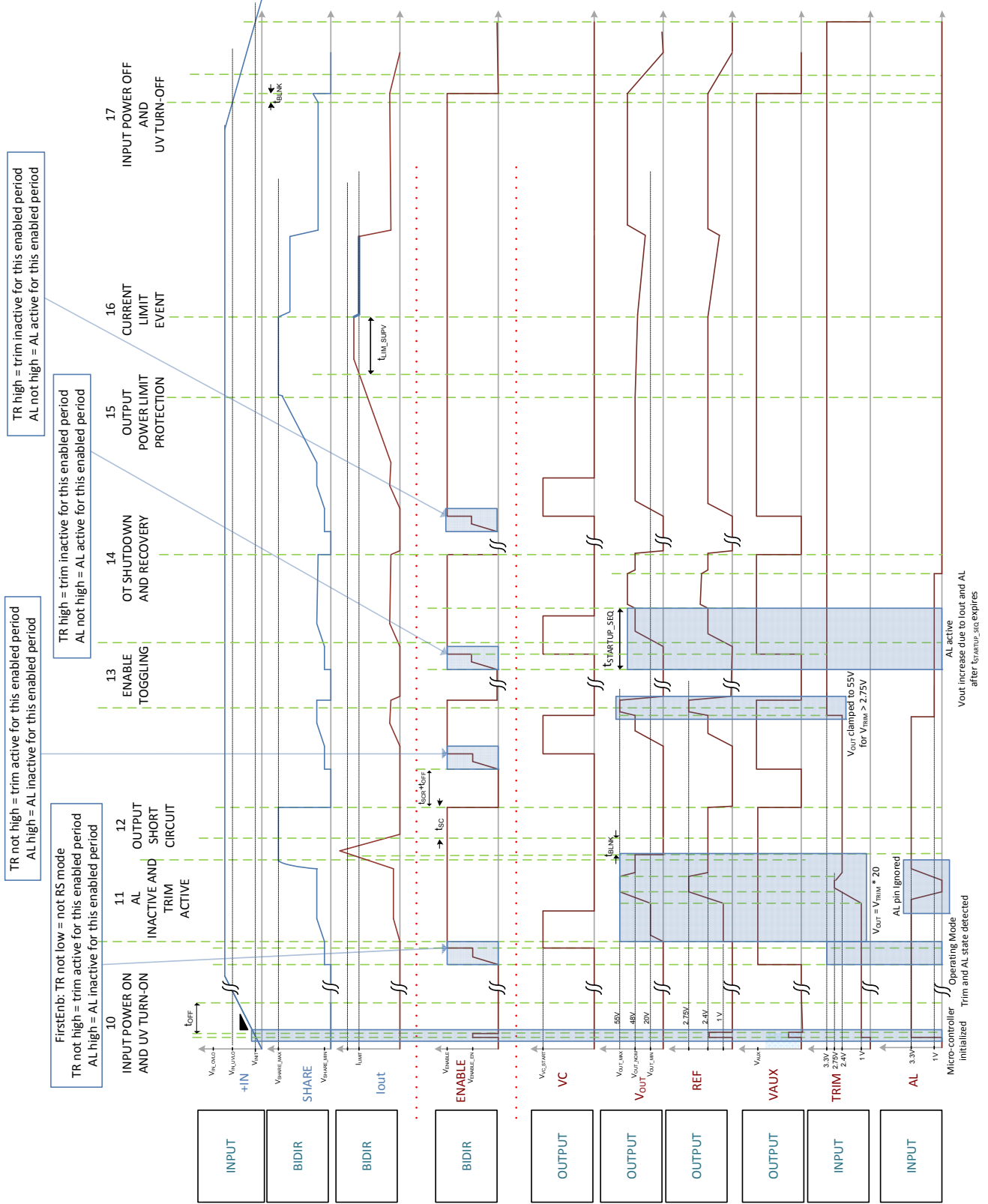

TIMING DIAGRAMS (Remote Sense operation page 1)

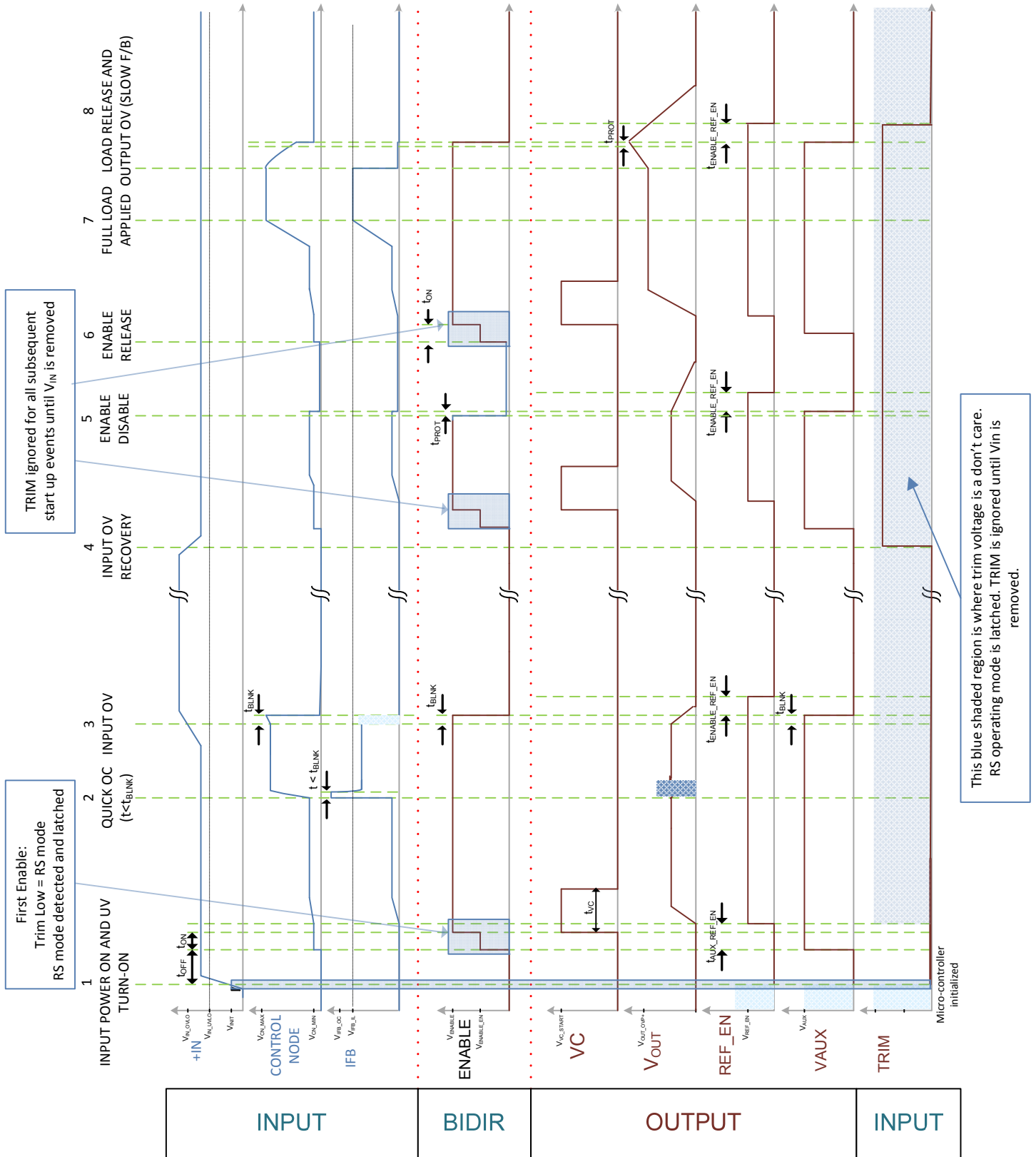

TIMING DIAGRAMS (Remote Sense operation page 2)

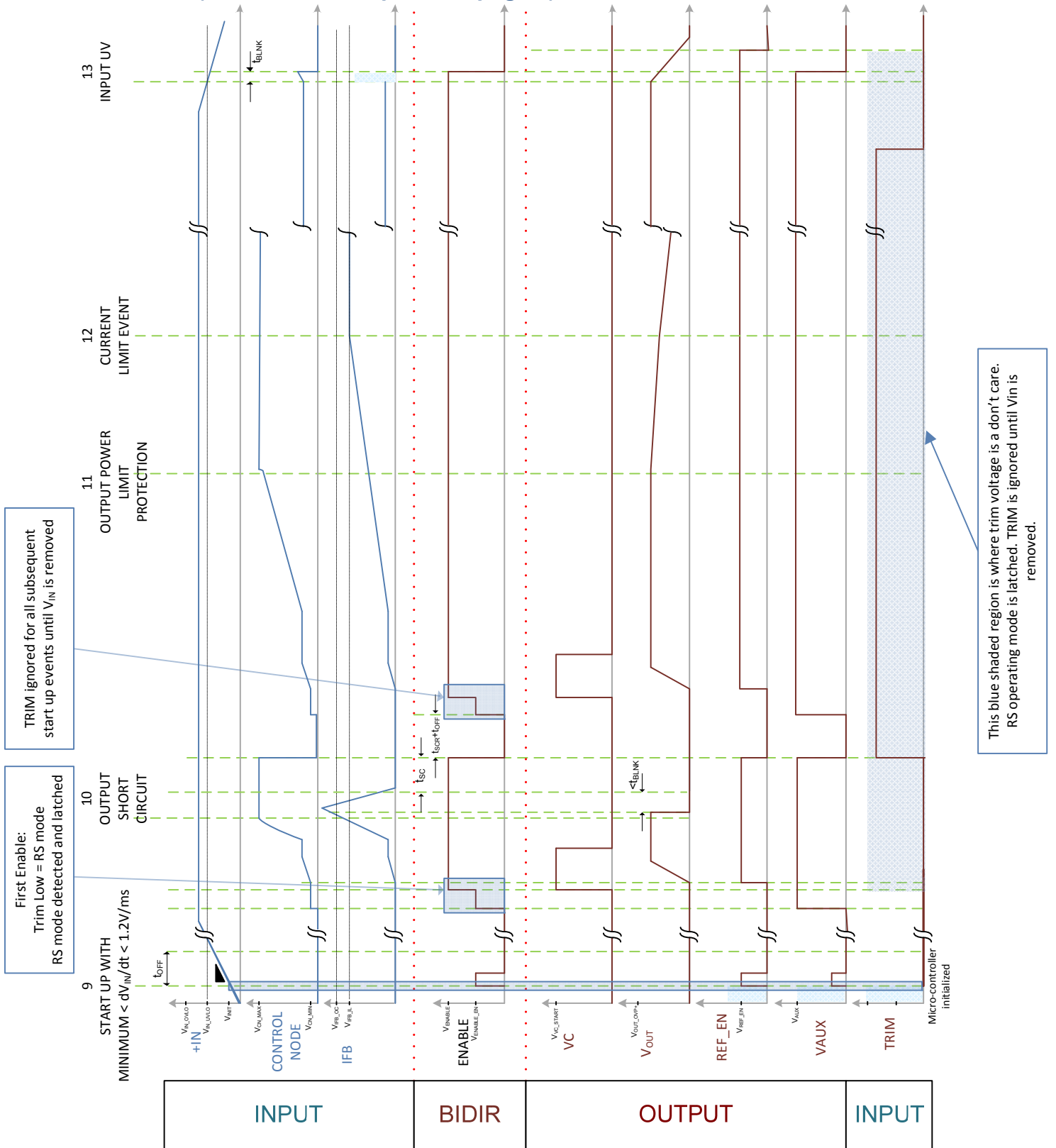

TYPICAL PERFORMANCE CHARACTERISTICS

The following figures present typical performance at $T_C = 25^\circ\text{C}$, unless otherwise noted.

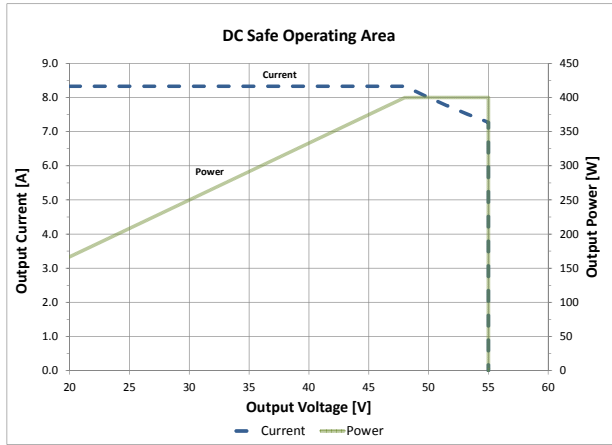

Figure 1: DC Safe Operating Area (SOA)

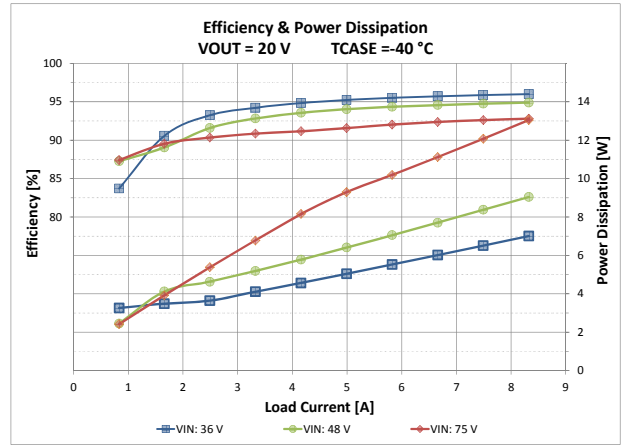

Figure 4: Total efficiency and power dissipation vs. V_{IN} and I_{OUT}
 $V_{OUT} = 20\text{ V}$, $T_{CASE} = -40^\circ\text{C}$

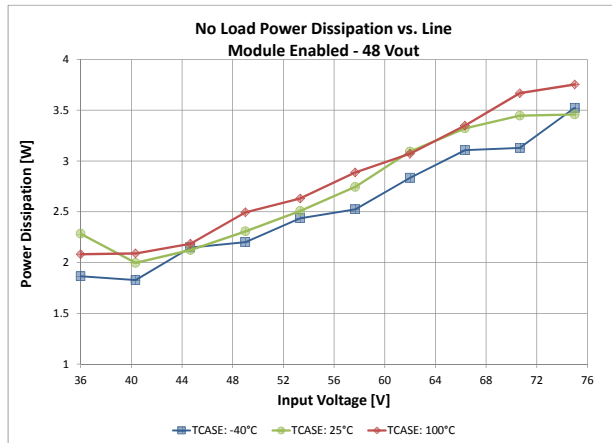

Figure 2: No Load Power Dissipation vs. V_{IN} , module enabled

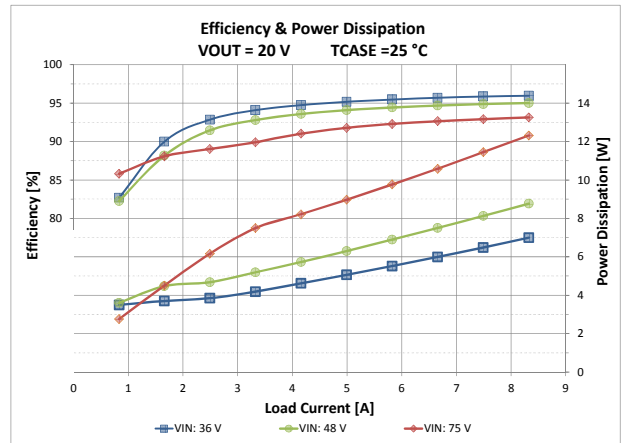

Figure 5: Total efficiency and power dissipation vs. V_{IN} and I_{OUT}
 $V_{OUT} = 20\text{ V}$, $T_{CASE} = 25^\circ\text{C}$

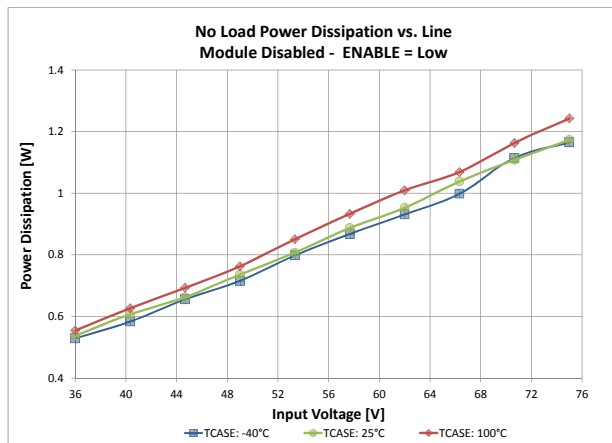

Figure 3: No Load Power Dissipation vs. V_{IN} , module disabled

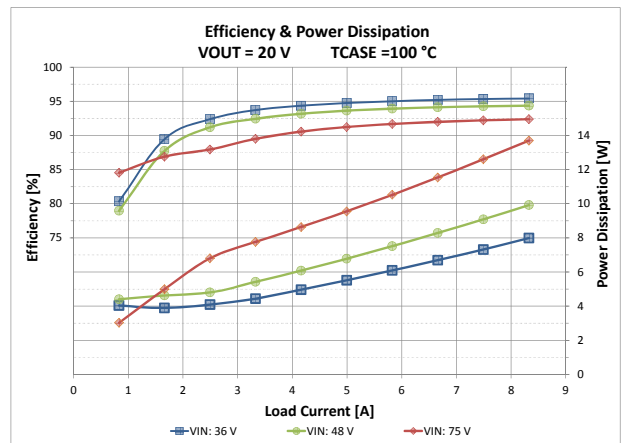

Figure 6: Total efficiency and power dissipation vs. V_{IN} and I_{OUT}
 $V_{OUT} = 20\text{ V}$, $T_{CASE} = 100^\circ\text{C}$

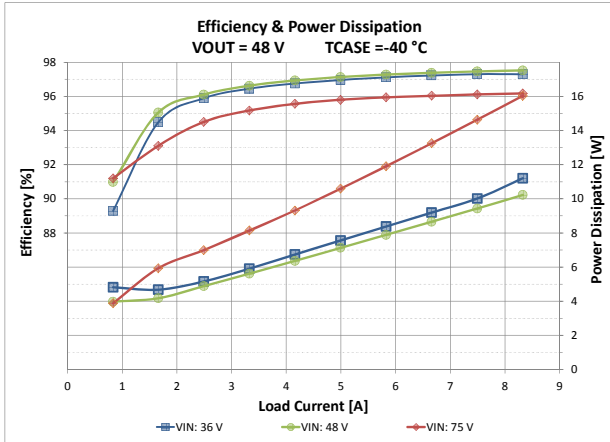

Figure 7: Total efficiency and power dissipation vs. V_{IN} and I_{OUT}
 $V_{OUT} = 48 \text{ V}$, $T_{CASE} = -40 \text{ }^\circ\text{C}$

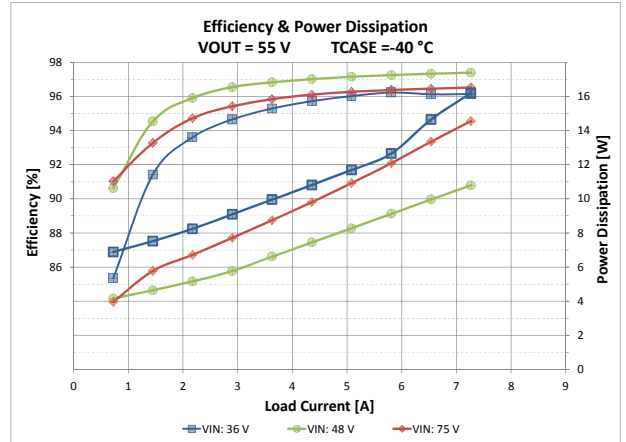

Figure 10: Total efficiency and power dissipation vs. V_{IN} and I_{OUT}
 $V_{OUT} = 55 \text{ V}$, $T_{CASE} = -40 \text{ }^\circ\text{C}$

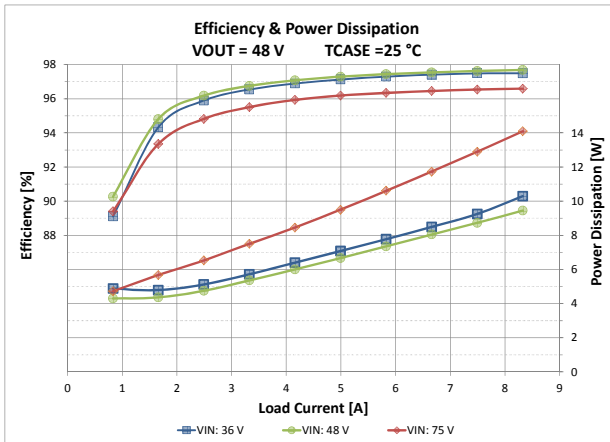

Figure 8: Total efficiency and power dissipation vs. V_{IN} and I_{OUT}
 $V_{OUT} = 48 \text{ V}$, $T_{CASE} = 25 \text{ }^\circ\text{C}$

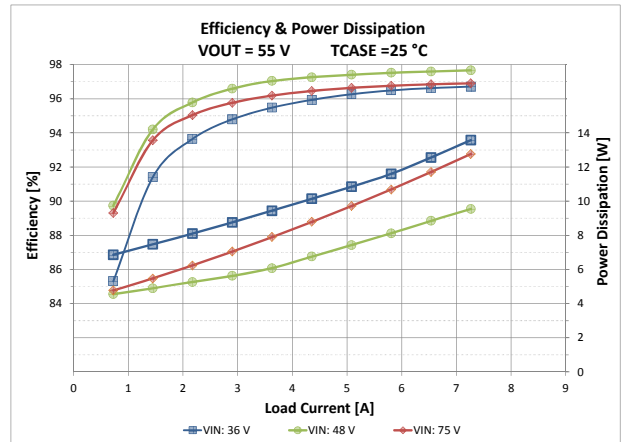

Figure 11: Total efficiency and power dissipation vs. V_{IN} and I_{OUT}
 $V_{OUT} = 55 \text{ V}$, $T_{CASE} = 25 \text{ }^\circ\text{C}$

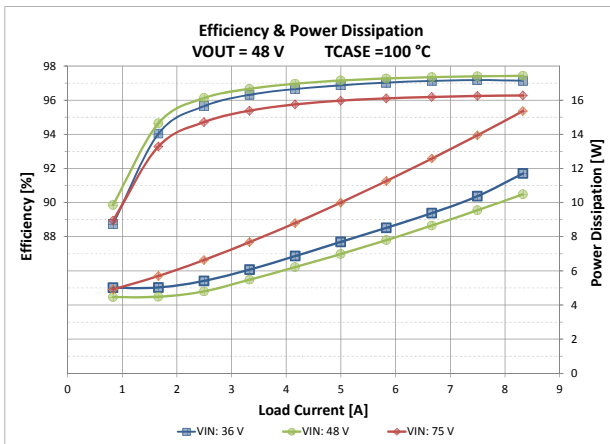

Figure 9: Total efficiency and power dissipation vs. V_{IN} and I_{OUT}
 $V_{OUT} = 48 \text{ V}$, $T_{CASE} = 100 \text{ }^\circ\text{C}$

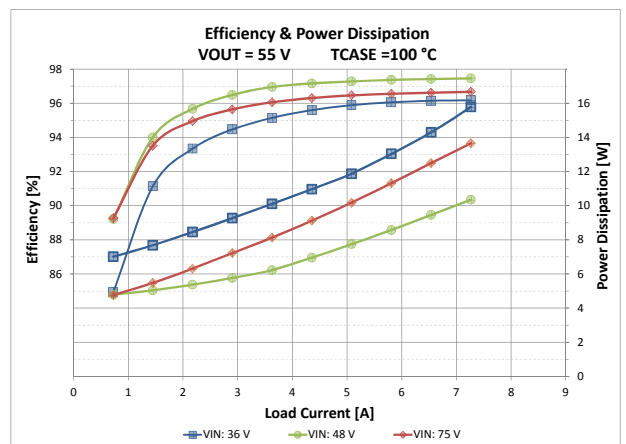

Figure 12: Total efficiency and power dissipation vs. V_{IN} and I_{OUT}
 $V_{OUT} = 55 \text{ V}$, $T_{CASE} = 100 \text{ }^\circ\text{C}$

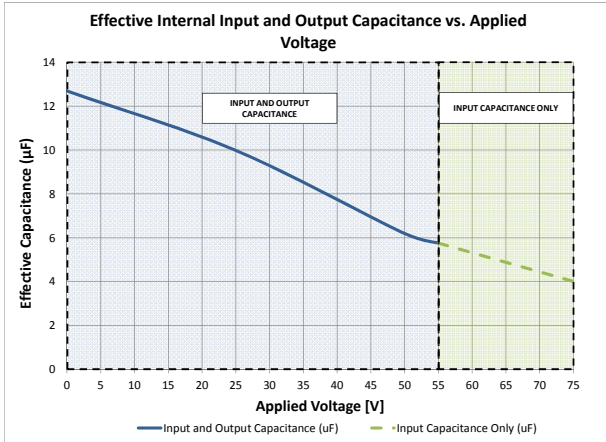

Figure 13 Effective Internal Input and Output Capacitance vs. Voltage – Ceramic Type

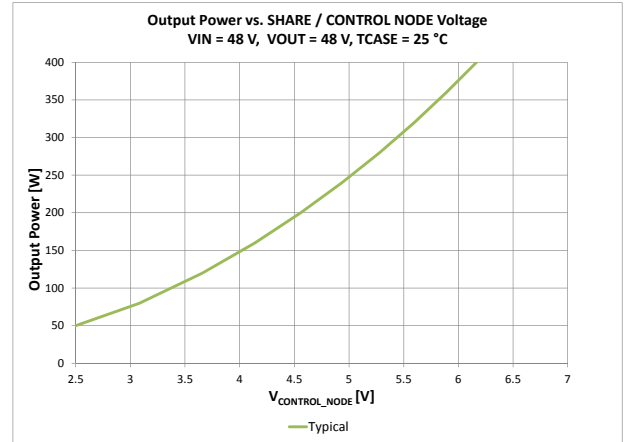

Figure 16 Output Power vs. SHARE / CONTROL NODE Voltage; $V_{IN} = 48\text{ V}$, $V_{OUT} = 48\text{ V}$, $T_{CASE} = 25\text{ }^\circ\text{C}$

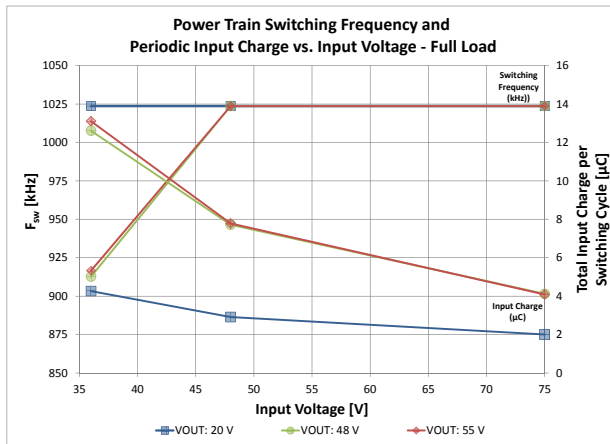

Figure 14: Power Train Switching Frequency and Periodic Input Charge vs. V_{IN} , V_{OUT} ; $I_{OUT} = 8.33\text{ A}$

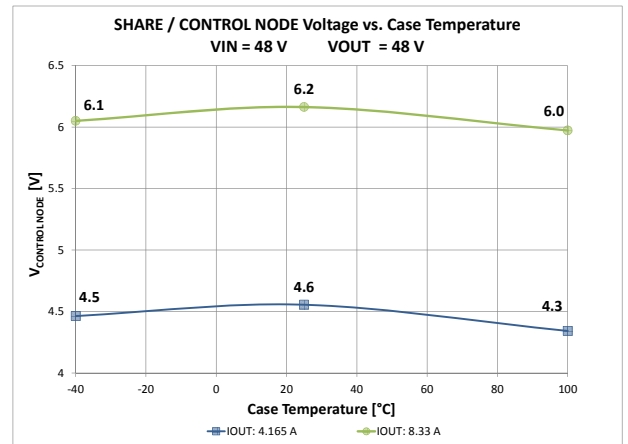

Figure 17: Typical SHARE / CONTROL NODE Voltage vs. T_{CASE} and I_{OUT} ; $V_{IN} = 48\text{ V}$, $V_{OUT} = 48\text{ V}$

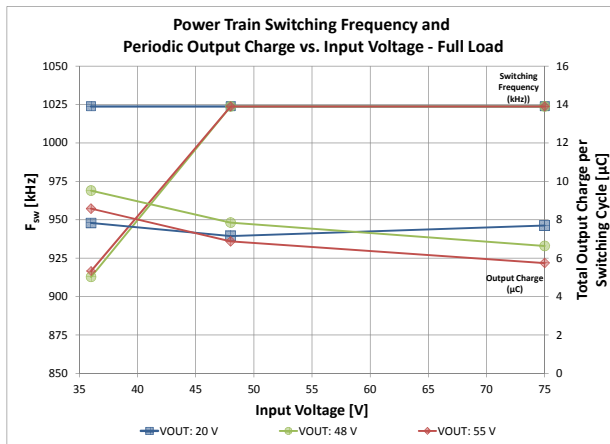

Figure 15: Power Train Switching Frequency and Periodic Output Charge vs. V_{IN} , V_{OUT} ; $I_{OUT} = 8.33\text{ A}$

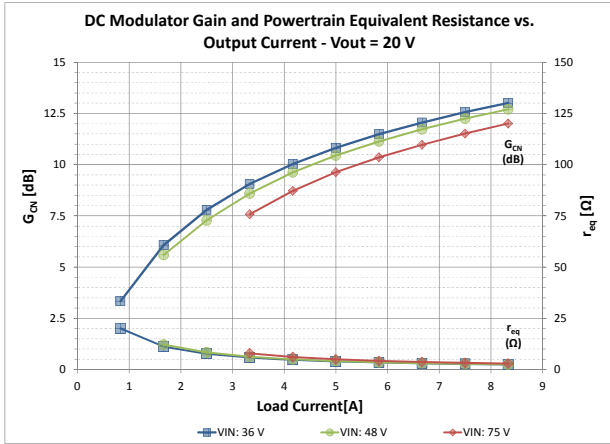

Figure 18 Powertrain Characteristics vs. I_{OUT}, V_{IN} Resistive Load, V_{OUT} = 20V

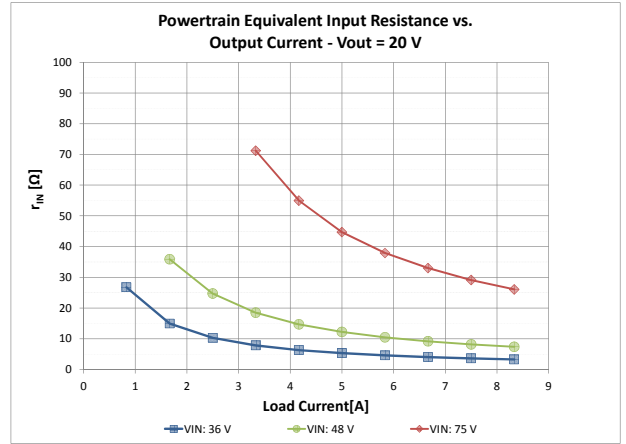

Figure 21 Magnitude of powertrain dynamic input impedance vs. I_{OUT}, V_{IN}; V_{OUT} = 20 V

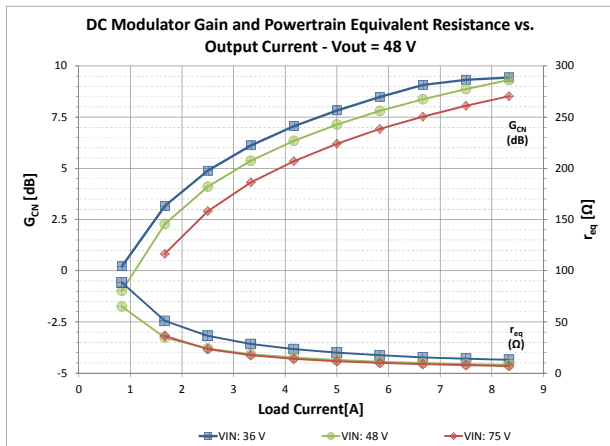

Figure 19 Powertrain Characteristics vs. I_{OUT}, V_{IN} Resistive Load, V_{OUT} = 48V

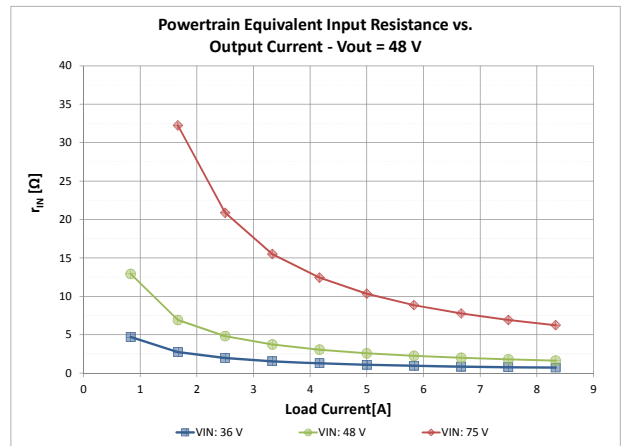

Figure 22 Magnitude of powertrain dynamic input impedance vs. I_{OUT}, V_{IN}; V_{OUT} = 48 V

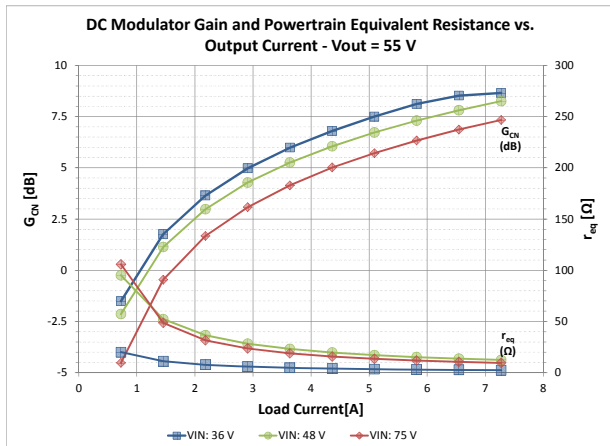

Figure 20 Powertrain Characteristics vs. I_{OUT}, V_{IN} Resistive Load, V_{OUT} = 55V

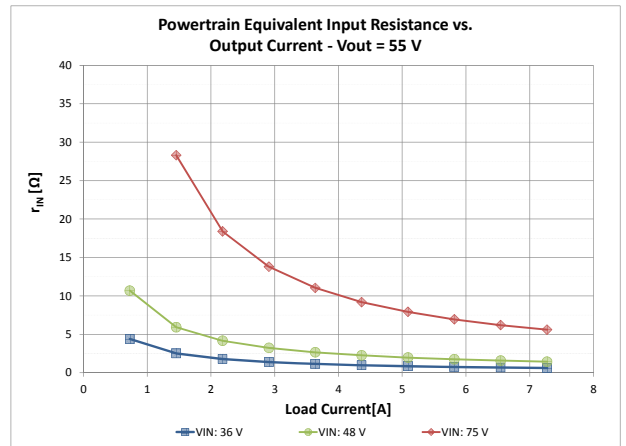

Figure 23 Magnitude of powertrain dynamic input impedance vs. I_{OUT}, V_{IN}; V_{OUT} = 55 V

GENERAL CHARACTERISTICS

Specifications apply over all line and load conditions, $T_{INT} = 25\text{ }^{\circ}\text{C}$ and output voltage from 20V to 55V, unless otherwise noted. **Boldface specifications apply over the temperature range of $-40\text{ }^{\circ}\text{C} < T_{INT} < 125\text{ }^{\circ}\text{C}$ (T-grade).**

Attribute	Symbol	Conditions / Notes	Min	Typ	Max	Unit
MECHANICAL						
Length	L		32.3	32.5	32.8	mm
			(1.27)	(1.28)	(1.29)	in
Width	W		21.8	22.0	22.3	mm
			(0.86)	(0.87)	(0.88)	in
Height	H		6.48	6.73	6.98	mm
			(0.255)	(0.265)	(0.275)	in
Volume	Vol	No heat sink		4.81		cm3
				(0.3)		in3
Weight	W			15		g
Lead Finish		Nickel	0.51		2.03	μm
		Palladium	0.02		0.15	
		Gold	0.003		0.050	
THERMAL						
Operating Internal Temperature	T_{INT}	T Grade	-40		125	$^{\circ}\text{C}$
		M Grade	-55		125	$^{\circ}\text{C}$
Thermal Impedance	$\theta_{INT-CASE}$			1		$^{\circ}\text{C/W}$
	$\theta_{INT-LEAD}$			3		$^{\circ}\text{C/W}$
Thermal Capacity				10		Ws/ $^{\circ}\text{C}$
ASSEMBLY						
Peak Compressive Force Applied to Case (Z-axis)		Supported by J-Lead only			6	lbs
					5.41	lbs/ in ²
Storage Temperature	T_{ST}	T Grade	-40		125	$^{\circ}\text{C}$
		M Grade	-65		125	$^{\circ}\text{C}$
Moisture Sensitivity Level	MSL	MSL 6, 245C Reflow				
		MSL5, 225C Reflow				
ESD Rating		Human Body Model, "JEDEC JESD 22-A114C.01"	1000			V
		Charged Device Model, "JEDEC JESD 22-C101D"	400			
SOLDERING						
Peak Temperature During Reflow		Under MSL 6 conditions above			245	$^{\circ}\text{C}$
		Under MSL 5 conditions above			225	$^{\circ}\text{C}$
Maximum Time Above 217 $^{\circ}\text{C}$					150	s
Peak Heating Rate During Reflow				1.5	2	$^{\circ}\text{C} / \text{s}$
Peak Cooling Rate Post Reflow				2.5	3	$^{\circ}\text{C} / \text{s}$
RELIABILITY AND AGENCY APPROVALS						
MTBF		Telcordia Issue 2 - Method I Case 1; Ground Benign, Controlled		5.28		MHrs
		MIL-HDBK-217Plus Parts Count - 25C Ground Benign, Stationary, Indoors / Computer Profile		4.01		MHrs
Agency Approvals / Standards		cTUV _{US} EN60950-1, UL/CSA 60950-1				
		CE Mark Low Voltage Directive (2006/95/EC)				
		ROHS 6 of 6				

PIN FUNCTIONS

+IN, -IN

Input power pins

+OUT, -OUT

Output power pins. Module cannot sink current.

ENABLE

This pin turns the supply on and off. The pin is both an input and an output and can provide the following features:

- Delayed Start: upon application of voltage ($>UVLO$) to the module power input and after t_{off} , the ENABLE pin will source a constant 90 μ A current.
- Output enable: When ENABLE is allowed to pull up above the enable threshold, the ENABLE pin will pull up to 5.0V with 1.8mA source capability, and the module will be enabled.
- Output disable: ENABLE may be pulled down externally in order to disable the module. Pull down resistance should be less than 235 Ω to SGND.
- Fault detection flag: The ENABLE 5.0V voltage source is internally turned off when a fault condition is latched.

ENABLE control should be implemented using an open collector configuration. It is not recommended to drive this pin externally.

VAUX: Auxiliary Voltage Source

Use this pin to power external devices with a non-isolated 9.0 V supply, with up to 5 mA load capability, switched with ENABLE input. Do not place a capacitor over 0.04 μ F on this pin.

SGND: Signal Ground

This is a low current pin which provides a Kelvin connection to the PRM's internal signal ground. Use this pin as the ground reference for external circuitry and signals to avoid voltage drops caused by high currents on power returns. In array configurations, SGND pins should be star connected at a single point. A series resistor ($\sim 1\Omega$) to the star location is recommended to decouple return currents.

VC: VTM Control

This output pin is used to temporarily provide V_{CC} voltage to connected VTMs during start up. The pulse is nominally 14V, 10 ms wide. A VTM can self-power once its input voltage reaches 26V. The PRM output must be checked to make sure it reaches this threshold voltage before the VC pulse expires.

TRIM

The TRIM pin is used to select the operating mode and to trim the PRM output when Adaptive Loop operating mode is selected. The TRIM pin has an internal pull-up to V_{CC_INT} through a 10 k Ω resistor.

Operating Mode Select:

If TRIM is pulled below 0.45 V during the first startup after V_{IN} is applied, Remote Sense / Slave operation is selected.

Otherwise, Adaptive Loop operation is selected.

This selection persists until V_{IN} is removed from the part, and is not changed by fault or disable events.

Output Voltage Trim:

Sets the output voltage of the PRM in Adaptive Loop operation.

If TRIM is permitted to pull up to 3.20 V or higher during start up, trim is disabled, and the output is set to the nominal of 48 V.

If TRIM is held between 1.00 V to 2.75 V during start up, trim is enabled, and the output is scaled by a factor of 20 resulting in an output voltage range of 20 V to 55 V.

This selection persists until the PRM is restarted with the ENABLE pin, or due to fault auto-recovery.

AL: Adaptive Loop (Adaptive Loop operation)

This input pin allows you to set the Adaptive Loop load line. Every volt on this pin represents 0.5 Ω of positive output slope. There is an internal 10 k Ω pullup resistor to V_{CC_INT} . If AL is permitted to pull up to 3.20 V or higher during start up, the Adaptive Loop load line is disabled.

This selection persists until the PRM is restarted with the ENABLE pin, or due to fault auto-recovery.

VT: VTM Temperature (Adaptive Loop operation)

This pin is used in the Adaptive Loop compensation algorithm to account for the VTM output resistance variation as a function of temperature. The VTM TM pin provides this voltage, scaled as the temperature in K (Kelvin) divided by 100, so 25 $^{\circ}$ C is 2.98 V. Leave disconnected or pull below 1.9V to disable. The adjustment is fixed at 0.3 %/ $^{\circ}$ C relative to the value at 25 $^{\circ}$ C

REF: Reference (Adaptive Loop operation)

This output pin allows you to monitor the internal reference voltage in Adaptive Loop operation. During normal operation it represents the output voltage scaled by a factor of 20.

In Adaptive Loop operation this pin is for monitoring purposes only and should not be driven or loaded externally.

REF_EN: Reference Enable (Remote Sense operation)

In Remote Sense operation this pin outputs a regulated 3.25V, 4mA voltage source. It is enabled only after successful start up of the PRM powertrain REF_EN is intended to power the output current transducer and also the voltage reference for the external control loop. Powering the reference generator with REF_EN helps provide a controlled start up, since the output voltage of the system is able to track the reference level as it comes up.

SHARE (Adaptive Loop and Slave operation)

This bus sets the output current level for all the PRM modules when operating in an array (master-slave configuration). Connect them together among the modules in the shared bus. One PRM should be configured as a master by connecting TRIM for Adaptive Loop operation. All other PRMs should be configured as slaves by pulling their respective TRIM pins low. This pin can be used to monitor the error voltage externally. 0 to 100% load is represented by a voltage between 0.79 V and 7.40.

CONTROL NODE (Remote Sense operation)

In Remote Sense operation, this is the input to the modulator which determines the powertrain timing and ultimately the module output power. An internal 0.5 mA current sink is always active. The bi-directional buffer between CONTROL NODE and the modulator has two states. In normal operation, CONTROL NODE will be above the 0.79 V switching threshold, and will drive the modulator through the buffer. An internal 7.4V clamp determines the maximum output power that can be requested of the modulator. When CONTROL NODE falls below 0.79 V, the converter will stop switching. An internal circuit clamps the modulator input to 0.79 V, and a buffer will source up to 2.5 mA out of the pin at that clamp level. For this reason, the output impedance of the amplifier driving CONTROL NODE must be taken into account. A rail-to-rail operational amplifier with low output impedance is always recommended.

The powertrain small signal (plant) response consists of a single pole determined by the load resistance, the powertrain equivalent output resistance, and the total output capacitance (internal and external to the module). Both the modulator gain

and the equivalent output resistance vary as a function of line, load and output voltage. As the load increases, the powertrain pole moves to higher frequency. As a result, the closed loop crossover frequency will be the highest at full load and lowest at minimum load. Figure 24 shows a reference AC small-signal model.

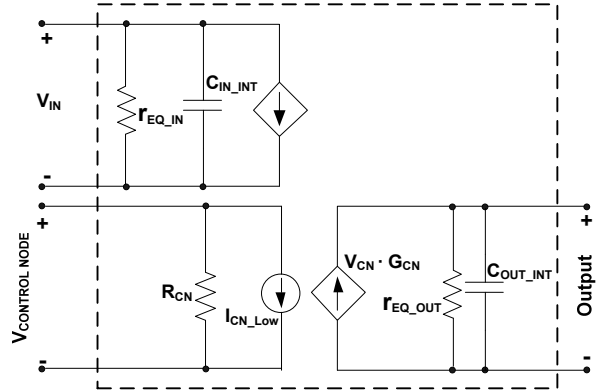

Figure 24 – PRM48A[x]480[y]400A00 AC small signal model

IFB: Current Feedback (Remote Sense operation)

In Remote Sense operation, IFB is the input for the module output overcurrent protection and current limit features. A voltage proportional to the powertrain output current must be applied to IFB in order for overcurrent protection to operate properly.

If the IFB voltage exceeds the IFB pin's overcurrent protection threshold, the powertrain will stop switching. If the IFB voltage falls below the overcurrent protection threshold within t_{BLANK} time, then the powertrain will immediately resume switching. Otherwise a fault is detected.

The current limit threshold for the IFB pin is set lower than the protection threshold. When the IFB pin average voltage exceeds the current limit threshold, an internal integrator will activate a clamp amplifier which overrides the modulator input maximum level. This causes the powertrain to maintain a constant output current.

The bandwidth of this current limit integrator is significantly slower than that of the CONTROL NODE input. Therefore this current limit cannot be used in lieu of properly compensating the (external) control loop to avoid exceeding maximum current or power ratings for the device.

DESIGN GUIDELINES

The PRM48A[x]480[y]400A00 regulator is specifically designed to provide a controlled Factorized Bus distribution voltage for powering downstream VTM Transformer — fast, efficient, isolated, low noise Point-of-Load (POL) converters.

The PRM48A[x]480[y]400A00 can be configured for two operating modes depending on the type of regulation required.

In Adaptive Loop operation the regulation circuitry is enabled within the device and regulates the voltage at the output terminals. The PRM48A[x]480[y]400A00 has a programmable Adaptive Loop load line which can be used to compensate for downstream VTM output resistance allowing for precise point of load regulation without the need for remote sensing.

In Remote Sense operation, the internal regulation circuitry is disabled and the voltage regulation circuitry is provided externally allowing for remote sensing directly at the point of load. In certain applications Remote Sense operation can improve regulation accuracy, and allow for operating with high amounts of load capacitance and optimizing load transient response.

Operating Mode Selection

The operating mode is selected through use of the TRIM pin.

When the part is first enabled after V_{IN} is applied, the TRIM voltage is sampled. The TRIM pin has an internal pull up resistor to V_{CC_INT} , so unless external circuitry pulls the pin voltage lower, it will float up to V_{CC_INT} .

If TRIM is pulled lower than 0.45V during the first startup after V_{IN} is applied, the part will be configured for Remote Sense / Slave operation, where the internal voltage regulation circuitry is disabled. In this case, for all subsequent operation the part will output a voltage dependent on the SHARE / CONTROL NODE voltage provided externally (either from an external regulation circuit or master PRM).

To configure the part for Remote Sense or Slave operation, connect the TRIM pin to SGND. It is recommended to make this connection through a 0 Ω jumper for troubleshooting purposes.

If the sampled TRIM voltage is higher than 0.55V during the first startup after V_{IN} is applied, then the part will be configured for Adaptive Loop operation, and the internal voltage regulation circuitry is enabled. The PRM will output a voltage dependent on the TRIM voltage, and will remain in this mode for as long as V_{IN} is applied.

To configure the part for Adaptive Loop operation, leave the TRIM pin disconnected, or apply a voltage/resistance within the specified range.

The operating mode is detected and latched during the first start up after V_{IN} is applied. This selection persists until V_{IN} is removed from the part, and is not changed by fault or disable events. Changing the operating mode can only be done by removing V_{IN} .

DESIGN GUIDELINES (Adaptive Loop operation)

In Adaptive Loop operation, the internal voltage control circuitry is enabled and the voltage at the output terminals is regulated. The part is nominally set to provide a fixed 48V output, and the TRIM pin can be used to adjust the output over the range of 20 V to 55 V.

When used with a VTM, the AL pin provides ability to program an Adaptive Loop load line to compensate for the output resistance (R_{OUT}) of a downstream VTM, while the VT pin provides temperature compensation to account for changes in the VTM R_{OUT} over temperature.

Trim Mode and Output Trim Control (Adaptive Loop operation)

In Adaptive Loop operation, during any start up and after ENABLE transitions high, the TRIM pin voltage is sampled to determine if trim is active or inactive. If the sampled TRIM voltage is higher than 3.20V then the PRM will disable trim. In this case, for all subsequent operation the output voltage will be programmed to the nominal output of 48V and the TRIM pin will be ignored during normal operation.

If the sampled TRIM voltage is between 1.0 V and 3.10 V then the PRM will activate trim mode and it will remain in this mode as long as the PRM is operating.

This selection persists until the PRM is restarted with the ENABLE pin, or due to fault auto-recovery.

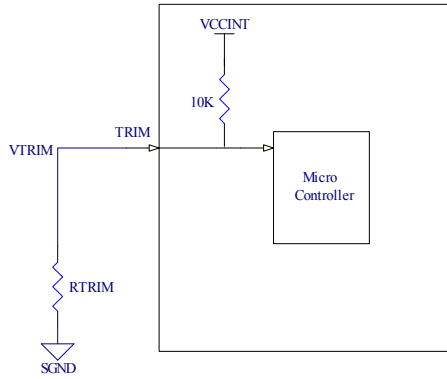

Figure 25: TRIM Connection

The output as a function of V_{TRIM} is defined by equation (1) for $1.00\text{ V} \leq V_{TRIM} \leq 2.75\text{ V}$, and allows for an output voltage ranging from 20V to 55V.

The TRIM pin is pulled up internally to V_{CC_INT} through a 10 k Ω resistor. V_{TRIM} can be actively set with a DAC that is ground referenced to SGND. V_{TRIM} can be passively set by connecting a resistor, R_{TRIM} , from TRIM to SGND such that the voltage divider made with V_{CC_INT} and the 10 k Ω pull up yields the desired V_{TRIM} . The formula for calculating this resistor is provided in Equation (1a).

$$V_{OUT} = V_{TRIM} \cdot 20 \quad (1)$$

$$R_{TRIM} = \frac{10k\Omega \cdot V_{TRIM}}{V_{CC_INT} - V_{TRIM}} = \frac{10k\Omega \cdot V_{OUT_SET}}{20 \cdot V_{CC_INT} - V_{OUT_SET}} \quad (1a)$$

For $1.00\text{ V} \leq V_{TRIM} \leq 2.75\text{ V}$

Where V_{OUT_SET} is the desired output voltage

The output voltage transfer function saturates for applied TRIM voltages above approximately 2.75V as illustrated in Figure 26 to prevent the output from being driven above its rated output voltage.

When TRIM is set lower than 1.00 V the output voltage is not specified and stable operation is not guaranteed.

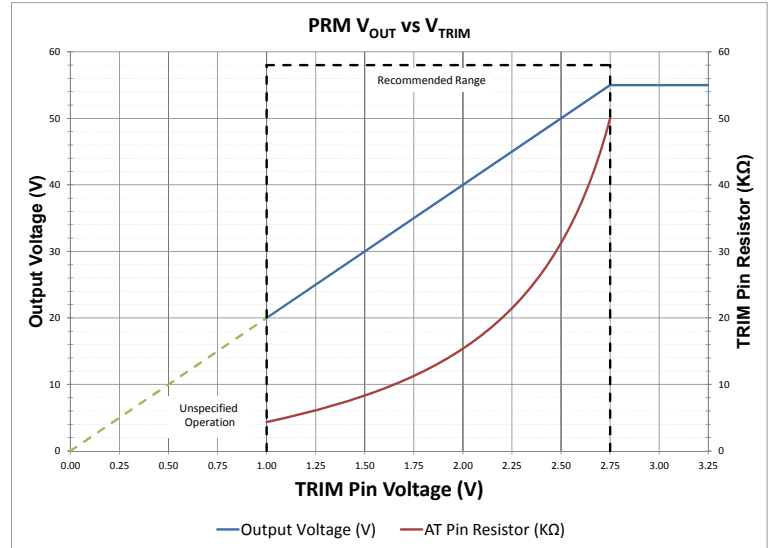

Figure 26: PRM V_{OUT} vs. V_{TRIM}

When trim is enabled the voltage at this pin is sampled at 120 μs intervals to determine the trim level. The output can be dynamically trimmed during normal operation, however it is not recommended to use this pin in an external analog feedback loop.

Refer to Table 1 for a summary of the TRIM pin functionality and the recommended voltage/resistance that should be applied to this pin.

TRIM PIN FUNCTION SUMMARY			
Operating State	V_{TRIM}	R_{TRIM}	Detected and Latched
Remote Sense / Slave Operation	<0.45V	<1 k Ω	After application of V_{IN} when ENABLE first transitions high
Adaptive Loop Operation	>0.55V ⁽²⁾	> 3 k Ω ⁽²⁾	After application of V_{IN} when ENABLE first transitions high
Adaptive Loop Operation Trim Mode	Trim Active $V_{OUT} = 20 \cdot V_{TRIM}$	1.00 V to 2.75 V	At every start up when ENABLE transitions high
	Trim Inactive $V_{OUT} = 48\text{V}$	>3.2 V	

Table 1: TRIM Pin Function Summary

⁽²⁾ It is not recommended to configure TRIM with a voltage less than 1.00V in Adaptive Loop operation

Adaptive Loop Compensation (Adaptive Loop operation)

A factorized power system naturally has a DC load line associated with it since the regulator stage (PRM) is positioned before the isolation and voltage transformation stage (VTM.) Consider for a moment a factorized power system that has the following parameters:

- $V_F = 40V$
- $K_{VTM}=1/4$
- $R_{OUT_VTM} = 10mohm @ 25^\circ C$

At no load the output voltage at the load will be equal to 10V ($V_F \cdot K_{VTM}$). With increasing load current, the output voltage at the load will drop at a rate proportional to the VTM's R_{OUT} . It should be noted that the R_{OUT} has a positive temperature coefficient and so the DC load line changes with temperature.

If the presence of this load line is acceptable for your application, then the PRM can be configured by way of the TRIM pin alone. Please refer to the Trimming the Output Voltage section for details. In this case both the AL and VT pins should be left open.

If the presence of this load line is undesirable, the load line can be eliminated by way of the PRM's Adaptive Loop (AL) engine.

The AL engine measures the output current of the PRM and accordingly increases the output voltage of the PRM in order to regulate the PRM's output resistance to a fixed negative resistance, R_{LL_AL} , settable by way of the AL pin. R_{LL_AL} should be sized to exactly cancel the R_{OUT} of the VTM at 25°C. The AL engine is also able to account for the positive temperature coefficient of R_{OUT} by way of its VT pin which will be explained shortly.

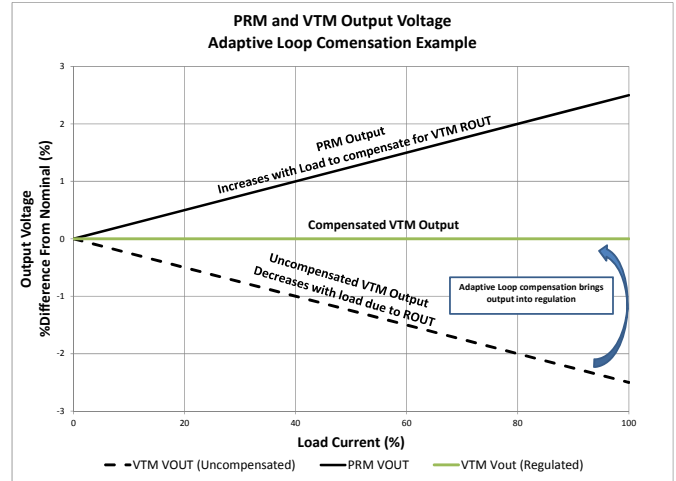

Figure 27: Adaptive Loop Compensation Illustration

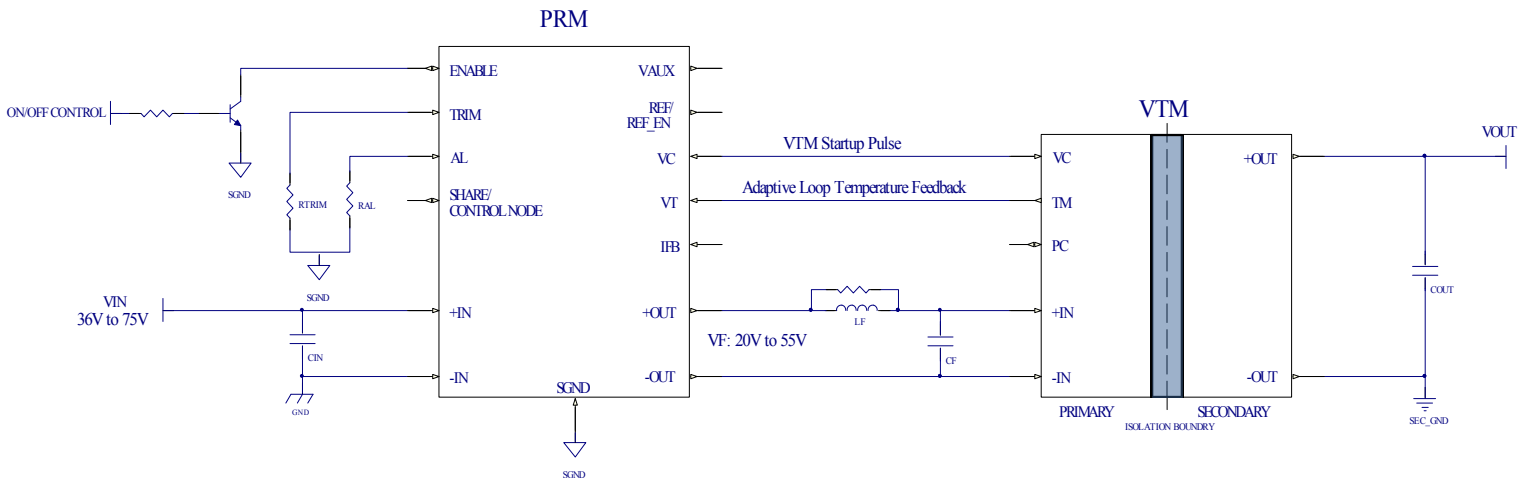

Figure 28: PRM-VTM Adaptive Loop Example

Setting the Adaptive Loop Load Line (Adaptive Loop operation)

To determine an appropriate value for the compensation slope (R_{LL_AL}) it helps to reflect the VTM's output resistance to the input side of the VTM. A resistance on the output side of the VTM is scaled by the VTM's transformer ratio (K_{VTM}) squared as defined by equation (2):

$$R_{LL_AL} = R_{OUT_REFL} = R_{OUT_VTM_25C} \cdot \left(\frac{1}{K_{VTM}}\right)^2 \quad (2)$$

Where
 R_{OUT_VTM} is the VTM output resistance at 25°C
 K_{VTM} is the VTM transformer ratio V_{IN}/V_{OUT}

For our hypothetical VTM from above (with $K_{VTM} = 1/4$ and $R_{OUT_VTM} = 10m\Omega$) the output resistance reflected over to the input would be equal to 160 mΩ. For this example, R_{LL_AL} should be set to -160 mΩ to approximately cancel at 25°C the inherent load line from the VTM.

R_{LL_AL} is set by the voltage difference between the AL pin and SGND pin, V_{AL} , per the following formula:

$$R_{LL_AL} = V_{AL} \cdot (-0.5) \Omega/V \quad (3)$$

$V_{AL} \leq 3.10V$
 Where V_{AL} is the voltage on the AL pin

V_{AL} is sampled by a 10-bit ADC, whose input is connected to V_{CC_INT} through a 10 kΩ pull up resistor. This pull up disables the AL engine when the AL pin is left open. V_{AL} can be actively set with a DAC that is ground referenced to SGND. V_{AL} can be passively set by connecting a resistor, R_{AL} , from AL to SGND such that the voltage divider made with V_{CC_INT} and the 10 kΩ pull up yields the desired V_{AL} . The formula for calculating this resistor is provided in Equation (4).

$$R_{AL} = \frac{10k\Omega \cdot V_{AL}}{V_{CC_INT} - V_{AL}} \quad (4)$$

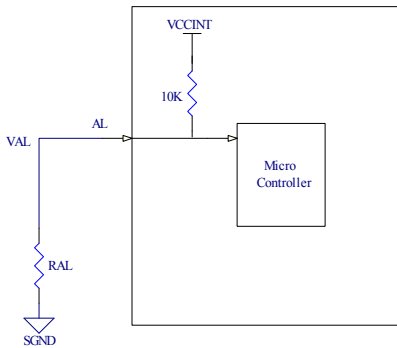

Figure 29: AL Connections

Similar to TRIM, AL is sampled during every start up to determine if the Adaptive Loop load line is enabled or disabled. If the AL pin is allowed to pull up to 3.20V or higher during start up, then the PRM will disable the Adaptive Loop load line as long as the PRM remains operating. In this case, for all subsequent operation the output voltage will remain at the set voltage, and the AL pin will be ignored. This selection persists until the PRM is restarted with the ENABLE pin, or due to fault auto-recovery.

When AL is enabled, the voltage at this pin is sampled at 120 μs intervals to determine the load line. The load line can be adjusted during normal operation, however it is not recommended to use this pin in an external analog feedback loop.

Adaptive Loop Temperature Compensation (Adaptive Loop operation)

By connecting the VT pin of the PRM to the VTM's TM pin, the PRM is able to monitor the internal temperature of the VTM. Knowing the VTM's internal temperature and the temperature coefficient of the VTM's R_{OUT} , which is preprogrammed into the PRM's microcontroller, the AL engine is able to scale the nominal value of R_{LL_AL} (set by the AL pin) to track the VTM's R_{OUT} over temperature. In this way the output resistance of the PRM can be tuned to cancel the output resistance of the VTM with the addition of a single resistor across the AL pin and a connection of the VTM's TM pin to the PRM's VT pin.

The VTM TM voltage is equal to the VTM internal sensed temperature in Kelvin divided by 100. For a temperature range of -55 °C to 125 °C the TM voltage will range from 2.18 V to 3.98 V. The Adaptive Loop temperature compensation is pre-programmed into the internal microcontroller and is 0.3 %/°C assuming the VT pin is connected to the TM pin of a compatible VTM

The TM pin has an internal pull down to SGND, and temperature compensation is disabled for VT voltages less than 1.9V. To disable temperature compensation, leave the VT pin unconnected and open circuit. When disabled, the temperature defaults 25 °C.

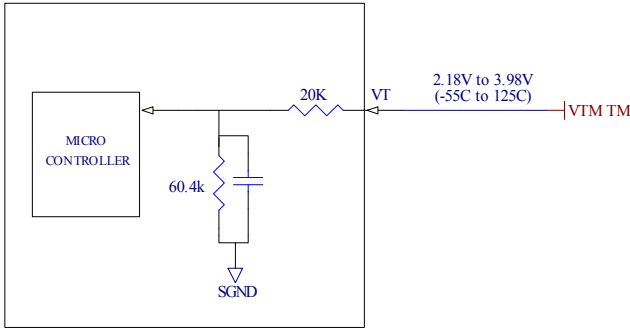

Figure 30: VT Connections

Stability Considerations and External Capacitance (Adaptive Loop operation)

In Adaptive Loop operation, the internal voltage regulation is enabled which has a pre-determined, fixed compensation network. The compensation is designed to be stable over a fixed set of operating and load conditions including load capacitance.

Besides internal output capacitors, external output capacitors also contribute to the closed loop frequency response, thus should be identified and understood, in order to maintain the control loop stability. This includes capacitance placed directly on the PRM output, as well as capacitance on the output of any downstream VTM (if used) reflected to its input.

Figure 32 illustrates the requirements for external capacitors of both the capacitance and ESR value. As shown in Figure 32 (a), the maximum capacitance value of ceramic capacitor is 25 μF , and the capacitance of a combination of ceramic and electrolyte capacitors needs to be less than 47 μF . As shown in Figure 32 (b) and (c), the ESR value of electrolyte capacitors needs to be between 0.1 Ω and 1.0 Ω ; the ESR value of ceramic capacitors needs to be between 2 m Ω and 200 m Ω .

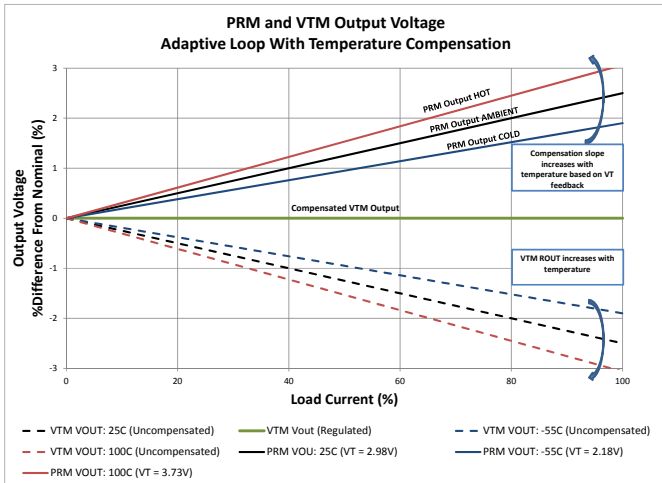
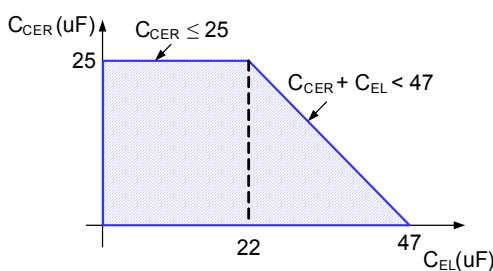
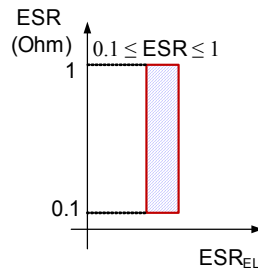

Figure 31: Adaptive Loop Temperature Compensation Illustration

The discussion thus far only considered the case where the AL engine is used to compensate for the R_{OUT} of the VTM. The AL engine can be more generally used to account for distribution resistances in both the factorized bus and the VTM's output distribution bus. For more information on how to apply the AL engine towards this end please contact Vicor's Applications Engineering department.



(a) Maximum Capacitance limits



(b) ESR_{EL} requirements

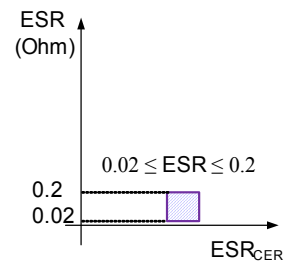

(c) ESR_{CER} requirements

Figure 32: Output Capacitance Limits

Current Limit (Adaptive Loop operation)

In Adaptive Loop operation, the current limit is controlled by the internal microcontroller. The current limit approximates a “brick-wall” limit where the output current is prevented from crossing the current limit threshold by reducing the output voltage. The current limit threshold is pre-programmed into the internal microcontroller and cannot be changed externally.

When the internal sensed current crosses the current limit threshold, the current limit will be activated after the detection time t_{LIM_SUPV} . Once activated, the microcontroller will reduce the error amplifier reference voltage (represented by REF) in order to maintain the output current at the limit value. Current limit is able to reduce the output down to V_{OUT_UVP} , below which the device will shut down do to output under voltage protection.

Soft Start Timing and Start up (Adaptive Loop operation)

In Adaptive Loop operation, the PRM has an internal soft start sequence which is initiated at every start up. This allows the PRM to start into fully discharged load capacitance. The soft start sequence ramps the output by modulating the error amplifier reference voltage (REF). The result is that the PRM output will rise at a controlled rate until the final voltage setpoint is reached. The total ramp time is typically 1.8ms independent of the output trim level. This soft start ramp time is preprogrammed into the microcontroller and cannot be changed externally.

Load Transient Response (Adaptive Loop Operation)

In Adaptive Loop operation, response time is dependent on the internal compensation. When the Adaptive Loop load line is disabled, the PRM output voltage will recover to the initial set value as illustrated in Figure 33 and Figure 34.

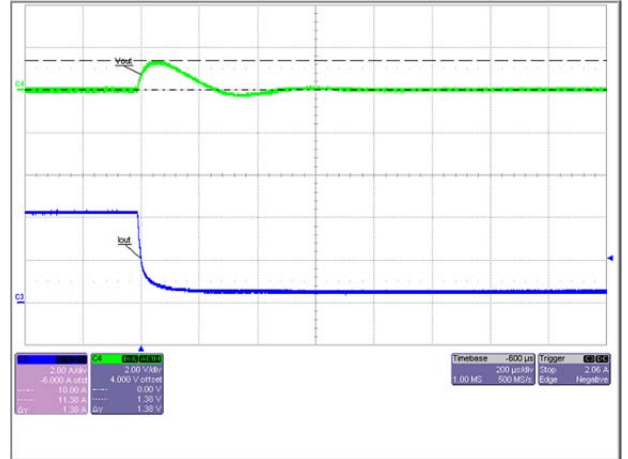

Figure 34: PRM Example 100% to 10% Load Transient Response, Adaptive Loop Load Line Disabled

When the Adaptive Loop load line is enabled, the voltage will recover to the value determined by the set point and Adaptive Loop load line settings as illustrated in Figure 35.

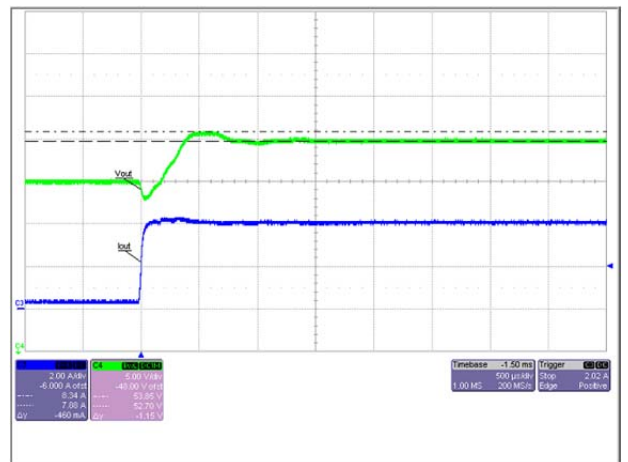

Figure 35: PRM Example 10% to 100% Load Transient Response, Adaptive Loop Load Line Enabled, $V_{AL} = 1.25V$

Actual response times are model dependent and will change based on the load step magnitude, load capacitance and operating conditions. Because the compensation is fixed internally the load transient response cannot be altered for Adaptive Loop operation. In order to improve the load transient response performance, the part can be configured for Remote Sense operation with an external voltage control loop optimized for the specific intended operating conditions. Remote Sense operation is described in a later section.

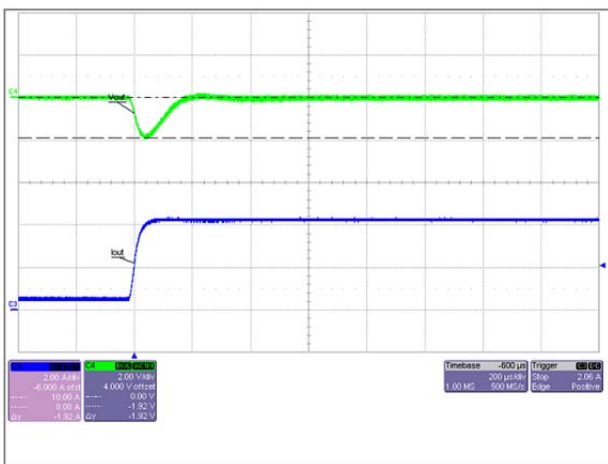

Figure 33: PRM Example 10% to 100% Load Transient Response, Adaptive Loop Load Line Disabled

Arrays (Adaptive Loop / Slave operation)

In Adaptive Loop operation a master-slave configuration is used for arrays. Up to 5 PRMs of the same type may be placed in parallel to expand the power capacity of the system. One PRM is designated as the master and contains the active control loop which considers control pin inputs and drives SHARE. The other PRMs listen to SHARE and act as slave powertrains only. The following high-level guidelines must be followed in order for the resultant system to start up and operate properly, and to avoid overstress or exceeding any absolute maximum ratings.

- One PRM must be designated as a master through configuring the TRIM pin voltage within the recommended range.
- All other PRMs must be designated as slave PRMs by tying TRIM pins to SGND. It is recommended to make this connection through a 0Ω jumper for troubleshooting purposes.
- All PRMs in the array must be powered from a common power source so that the input voltage to each PRM is the same. The IN pins of all PRMs must be connected together.
- An independent fuse for each PRM +IN connection is required to maintain safety certifications (see Fusing section).
- An independent inductor for each PRM +IN connection is recommended when used in an array, to control circulating currents among the PRM inputs and reduce the impact of beat frequencies.
- Mismatches in both inductance, and resistance from the common power source to each PRM should be minimized.
- ENABLE pins must be connected together for start up synchronization and proper fault response of the array.

- SHARE pins must be connected together to enable sharing. The bandwidth requirements of SHARE are low enough that the bus can be considered a lumped element, rather than a transmission line, and so star connections to the master PRM with stubs, as well as daisy chain connections are permitted.
- The resistances between slave unit SHARE pins and the master's should be well matched, to avoid introducing additional sharing mismatches. The SHARE bus should not be routed under any PRM. SHARE bus parasitic capacitance to +IN or +OUT should be minimized.
- SGND of the master PRM is the reference for all control loop functions. The SGND pins of each slave PRMs should be connected to the SGND reference node on the board through a 1 Ω resistor.
- When operating within an array, the master PRM is rated for full power while the slave PRMs are de-rated to the array rated power and current values provided for Slave operation (P_{OUT_ARRAY} , I_{OUT_ARRAY}). The number of PRMs required to achieve a given array capacity must consider these de-ratings to avoid overstressing any PRM in the array.
- Adaptive Loop design procedures above will hold for an array, in general, although some parameters must be scaled against the number of PRMs in the system.

Arrays of more than 5 PRMs may be possible through use of external circuitry. Please contact Vicor Applications for assistance with array sizing above 5 units.

DESIGN GUIDELINES (Remote Sense operation)

In Remote Sense operation, the PRM48A[x]480[y]400A00 is an intelligent powertrain module designed to fully exploit external output voltage feedback and current sensing sub-circuits. These two external circuits are illustrated in Figure 36, which shows an example of the PRM in a standalone application with local voltage feedback and high side current sensing.

In general, these circuits include a precision voltage reference, an operational amplifier which provides closed loop feedback compensation, and a high side current sense circuit which includes a shunt and current sense IC.

The following design procedures refer to the circuit shown in Figure 36.

Setting the Output Voltage Level (Remote Sense operation)

The output voltage setpoint is a function of the voltage reference and the output voltage sense ratio. With reference to Figure 36, R1 and R2 form the output voltage sensing divider which provides the scaled output voltage to the negative input of the error amplifier; a dedicated reference IC provides the reference voltage to the positive input of the error amplifier. Under normal operation, the error amplifier will keep the voltages at the inverting and non-inverting inputs equal, and therefore the output voltage is defined by:

$$V_{OUT} = V_{ref} \cdot \frac{R1 + R2}{R2} \quad (5)$$

Note that the component R1 will also factor into the compensation as described in a later section.

It is important to apply proper slew rate to the reference voltage rise when the control loop is initially enabled. The recommended range for reference rise time is 1 ms to 9 ms. The lower rise time limit will ensure optimized modulator timing performance during start up, and to allow the current limit feature (through IFB pin) to fully protect the device during power-up. The upper rise time limit is needed to guarantee a sufficient factorized bus voltage is provided to any downstream VTM input before the end of the VC pulse.

Setting the Output Current Limit and Overcurrent Protection Level (Remote Sense operation)

In Remote Sense operation, the internal current sensing is disabled, and an external current sense amplifier must be implemented to provide feedback to the IFB pin.

The current limit and overcurrent protection set points are linked, and scale together against the current sense shunt, and the gain of the current sense amplifier. The output of the current sense IC provides the IFB voltage which has V_{IFB_IL} and V_{IFB_OC} thresholds for the two functions respectively. The set points are therefore defined by:

$$I_{IL} = \frac{V_{IFB_IL}}{R_S \cdot G_{CS}} \quad (6)$$

and

$$I_{OC} = \frac{V_{IFB_OC}}{R_S \cdot G_{CS}} \quad (7)$$

where G_{CS} is the gain of the current sense amplifier.

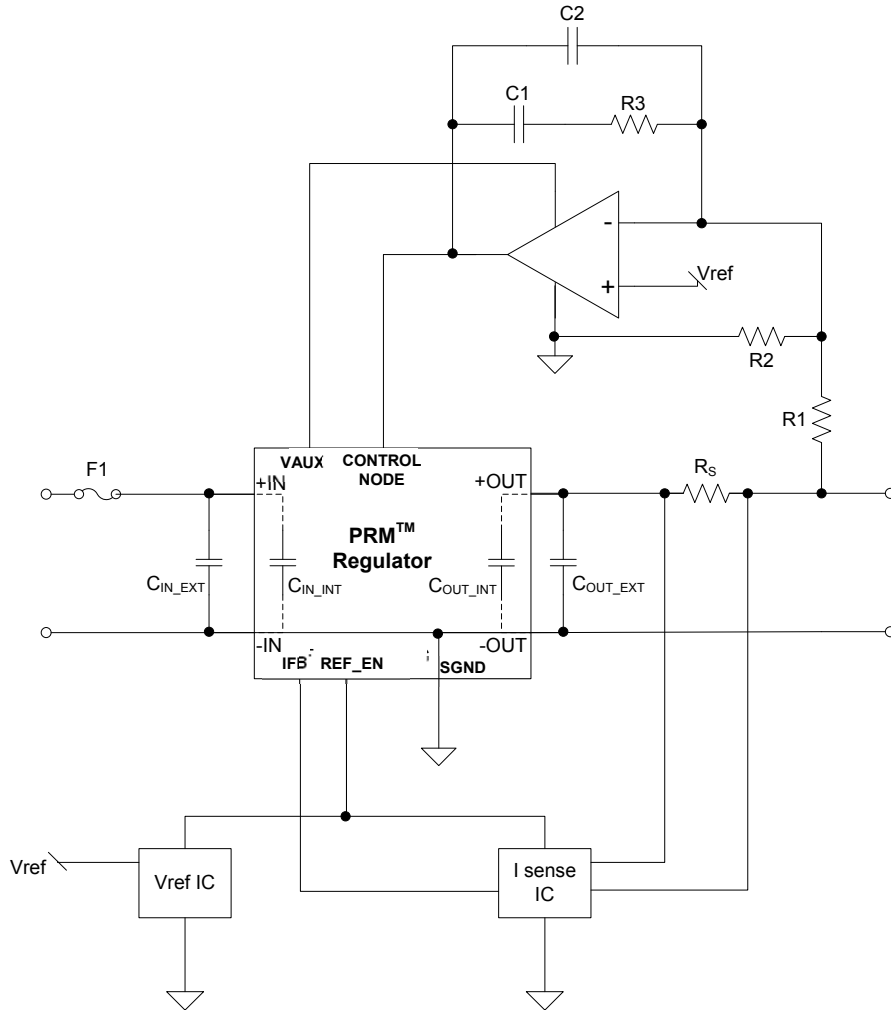

Figure 36: Remote Sense Example

Control Loop Compensation Requirements (Remote Sense operation)

In order to properly compensate the control loop, all components which contribute to the closed loop frequency response should be identified and understood. Figure 24 shows the AC small signal model for the module. Modulator DC gain G_{CN} and powertrain equivalent resistance r_{EQ_OUT} are shown. These modeling parameters will support a design cut-off frequency up to 50kHz.

Standard Bode analysis should be used for calculating the error amplifier compensation and analyzing the closed loop stability. The recommended stability criteria are as follows:

- 1) Phase Margin > 45° : for the closed loop response, the phase should be greater than 45° where the gain crosses 0dB.
- 2) Gain Margin > 10dB : The closed loop gain should be lower than -10dB where the phase crosses 0°.
- 3) Gain Slope = -20dB/decade : The closed loop gain should have a slope of -20dB/decade at the crossover frequency.

The compensation characteristics must be selected to meet these stability criteria. Refer to Figure 37 for a local sense, voltage-mode control example based on the configuration in Figure 36. In this example, it is assumed that the maximum crossover frequency (F_{C_MAX}) has been selected to occur between B and C. Type-2 compensation (Curve IJKL) is sufficient in this case.

The following data must be gathered in order to proceed:

- Modulator Gain G_{CN} : See Figures 18, 19, 20
- Powertrain equivalent resistance r_{EQ} : See Figures 18, 19, 20
- Internal output capacitance: see Figure 13
- External output capacitance value

In the case of ceramic capacitors, the ESR can be considered low enough to push the associated zero well above the frequency of interest. Applications with high ESR capacitor may require a different type of compensation, or cascade control.

The system poles and zeros of the closed loop can then be defined as follows:

- Powertrain pole, assuming the external capacitor ESR is negligible:

$$R_{C_{OUT_EXT}} \ll \frac{r_{EQ_OUT} \cdot R_{LOAD}}{r_{EQ_OUT} + R_{LOAD}}$$

- Main pole frequency:

$$F_p \approx \frac{1}{2\pi \cdot \frac{r_{EQ_OUT} \cdot R_{LOAD}}{r_{EQ_OUT} + R_{LOAD}} \cdot (C_{OUT_INT} + C_{OUT_EXT})}$$

- Compensation Mid-Band Gain:

$$G_{MB} = 20 \log \frac{R_3}{R_1} \quad (8)$$

- Compensation Zero:

$$F_{Z1} = \frac{1}{2\pi \cdot R_3 \cdot C_1} \quad (9)$$

- Compensation Pole:

$$F_{P2} = \frac{1}{2\pi \cdot \frac{R_3 \cdot C_1 \cdot C_2}{C_1 + C_2}}$$

and for $F_{P2} \gg F_{Z1}$ ($C_1 + C_2 \approx C_1$):

$$F_{P2} \approx \frac{1}{2\pi \cdot R_3 \cdot C_2} \quad (10)$$

Midband Gain Design: R1,R3 (Remote Sense operation)

With reference to Figure 37: curve ABC is the:

- minimum output voltage in the application
- maximum input voltage expected in the application
- maximum load

PRM open loop response, and is where the maximum crossover frequency occurs. In order for the maximum crossover frequency to occur at the design choice F_{CMAX} , the compensation gain must be equal and opposite of the powertrain gain at this frequency. For stability purposes, the compensation should be in the Mid-band (J-K) at the crossover. Using Equation (8), the mid-band gain can be selected appropriately.

Compensation Zero Design :C1 (Remote Sense operation):

With reference to Figure 37: curve EFG is the:

- maximum output voltage in the application
- minimum input voltage expected in the application
- minimum load in the application

PRM open loop response, and is where the minimum crossover frequency F_{CMIN} occurs. Based on stability criteria, the compensation must be in the mid-band at the minimum crossover frequency, therefore F_{CMIN} will occur where EFG is equal and opposite of G_{MB} . C1 can be selected using Equation (9) so that F_{Z1} occurs prior to F_{CMIN} .

High Frequency Pole Design: C2 (Remote Sense operation):

Using Equation (10), C2 should be selected so that F_{P2} is at least one decade above F_{CMAX} and prior to the gain bandwidth product of the operational amplifier (10MHz for this example). For applications with a higher desired crossover frequency the use of a high gain bandwidth product amplifier may be necessary to ensure that the real pole can be set at least one decade above the maximum crossover frequency.

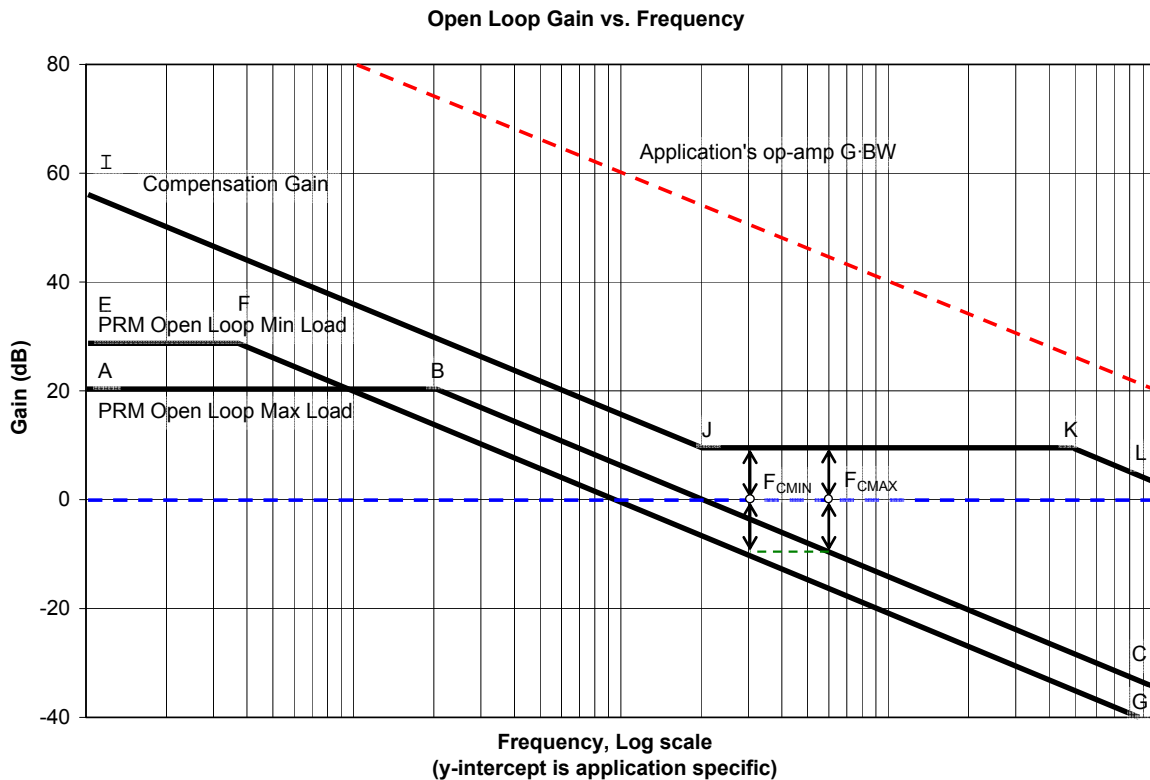

Figure 37 – Reference asymptotic Bode plot for the considered system

Arrays (Remote Sense operation)

In Remote Sense operation up to 10 PRMs of the same type may be placed in parallel to expand the power capacity of the system. All PRMs within the array are configured for Remote Sense operation and are driven by an external control circuit which considers the control inputs and drives the CONTROL NODE bus. The following high-level guidelines must be followed in order for the resultant system to start up and operate properly, and to avoid overstress or exceeding any absolute maximum ratings.

- All PRMs must be configured for Remote Sense operation by tying TRIM pins to SGND. It is recommended to make this connection through a 0 Ω jumper for troubleshooting purposes.
- All PRMs in the array must be powered from a common power source so that the input voltage to each PRM is the same.
- An independent fuse for each PRM +IN connection is required to maintain safety certifications (see Fusing section).
- An independent inductor for each PRM +IN connection is recommended when used in an array, to control circulating currents among the PRM inputs and reduce the impact of beat frequencies.
- Mismatches in both inductance, and resistance from the common power source to each PRM should be minimized.
- ENABLE pins must be connected together for start up synchronization and proper fault response of the array.
- Reference supply to the control loop voltage reference and current sense circuitry must be enabled when all modules' REF_EN pins have reached their operational voltage levels.
- A single external control circuit must be implemented as described in the Remote Sense operation design guidelines. The control circuit should drive the CONTROL NODE bus.
- CONTROL NODE pins must be connected together to enable sharing. The bandwidth requirements of CONTROL NODE are low enough that the bus can be considered a lumped element, rather than a transmission line, and so star connections as well as daisy chain connections are permitted.
- Each PRM must have its own local current shunt and current sense circuitry to drive its IFB pin.
- The resistances between CONTROL NODE pins should be well matched, to avoid introducing additional

sharing mismatches. The CONTROL NODE bus should not be routed under any PRM. Parasitic capacitance to +IN or +OUT should be minimized.

- One PRM should be designated to provide the SGND reference, VAUX, and REF_EN voltages for the external circuitry.
- The SGND pins of all other PRMs should be connected to the SGND reference node on the board through a 1 Ω resistor.
- When operating within an array, the PRMs are de-rated to the array rated power and current values provided for Remote Sense operation (P_{OUT_ARRAY} , I_{OUT_ARRAY}). The number of PRMs required to achieve a given array capacity must consider these de-ratings to avoid overstressing any PRM in the array.
- When using VAUX to power external circuitry, total current draw including CONTROL NODE sink currents must be taken into account to ensure the maximum VAUX current is not exceeded. Arrays of more than 5 PRMs may require additional circuitry to provide the required source current. Contact Vicor Applications Engineering for more information.

DESIGN GUIDELINES (General Operation)

The following guidelines are general guidelines that apply to any mode of operation.

FPA System Considerations

There are a few system level design considerations that should be carefully considered when using a PRM and VTM to implement a Factorized Power Architecture (FPA) system

The VC pin of the PRM should be directly connected to the VC pin of the VTM. The PRM and VTM coordinate the soft start sequence of the FPA system through this connection. If the VC pins are not connected the VTM will not start up. When the PRM is ready to start up, it applies a voltage on VC, which enables and powers the VTM’s powertrain. The PRM then proceeds to ramp up its output voltage. After approximately 10ms, VC returns to 0V and the VTM can then derive power directly from the factorized bus provided that the factorized bus voltage is above the minimum specified VTM operating input voltage when the VC pulse expires.

All VTM faults latch the VTM powertrain off. Input power to the system as a whole must be recycled or the PRM should be disabled and enabled by way of its ENABLE pin in order to restart the system. It is recommended that the voltage on the factorized bus return to zero before the PRM is re-enabled. Otherwise the soft start of the system may be compromised.

A RL filter should be placed between the PRM and VTM to locally isolate switching ripple currents that can interfere with module operation. It is important that the inductance have an impedance that is much greater than that of the PRM output capacitance and VTM input capacitance at the switching frequencies of the devices. A resistor should be placed in shunt to this inductor to dampen the resultant LC tank. For most cases 100nH in parallel with 10Ω is sufficient to isolate the switching ripple currents.

Verifying Stability:

A load step transient response can be used in order to estimate stability.

Figure 38 illustrates an example of a load step response. Equation (11) can be used to predict the phase margin based on the ratio of the “kick” to “droop” (as defined in Fig. 38).

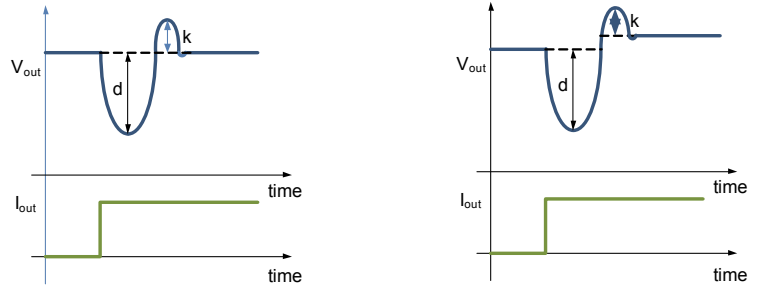

(a) without Adaptive Loop (b) with Adaptive Loop

Figure 38 – load step response example and “droop” vs. “kick” definition. (a) with Adaptive Loop; (b) without Adaptive Loop.

$$\Phi_m \approx 100 \sqrt{\frac{\left(\ln \frac{k}{d}\right)^2}{\left(\ln \frac{k}{d}\right)^2 + \pi^2}} \tag{11}$$

Burst Mode Operation:

At light loads, the PRM will operate in a burst mode due to minimum timing constraints. An example burst operation waveform is illustrated in Figure 39.

For very light loads, and also for higher input voltages, the minimum time power switching cycle from the powertrain will exceed the power required by the load. In this case the error amplifier will periodically drive SHARE/CONTROL NODE below the switching threshold in order to maintain regulation. Switching will cease momentarily until the error amplifier once again drives SHARE/CONTROL NODE voltage above the threshold.

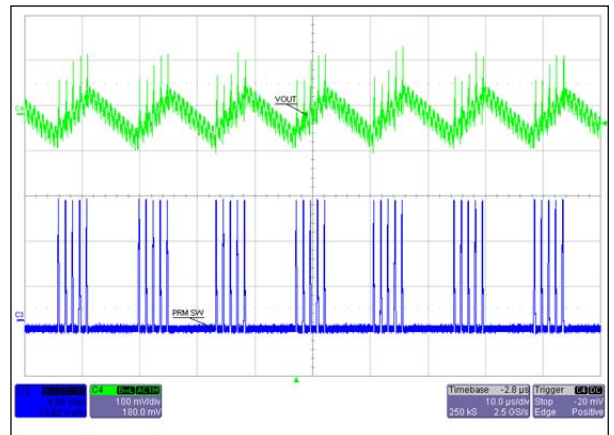

Figure 39 – light load burst mode of operation

Note that during the bursts of switching, the powertrain frequency is constant, but the number of pulses as well as the time between bursts is variable. The variability depends on many factors including input voltage, output voltages, load impedance, and error amplifier output impedance.

In burst mode, the gain of the SHARE/CONTROL NODE input to the plant which is modeled in the previous sections is time varying. Therefore the small signal analysis cannot be directly applied to burst mode operation.

Input and Output filter design

Figures 14 and 15 provide the total input and output charge per cycle, as well as switching frequency, of the PRM at full load under various input and output voltages conditions.

Figure 13 provides the effective internal capacitance of the module. A conservative estimate of input and output peak-peak voltage ripple at nominal line and trim is provided by equation (12):

$$\Delta V = \frac{Q_{TOT} - \frac{I_{FL} \cdot 0.4}{f_{SW}}}{C_{INT} + C_{EXT}} \quad (12)$$

Q_{TOT} is the total input (Fig. 14) or output (Fig. 15) charge per switching cycle at full load, while C_{INT} is the module internal effective capacitance at the considered voltage (Fig. 13) and C_{EXT} is the external effective capacitance at the considered voltage.

Input filter stability

The PRM can provide very high dynamic transients. It is therefore very important to verify that the voltage supply source as well as the interconnecting line are stable and do not oscillate. For this purpose, the converter dynamic input impedance magnitude $|r_{EQ_IN}|$ is provided in Figures 21, 22, 23. It is recommended to provide adequate design margin with respect to the stability conditions illustrated in the previous sections.

Inductive source and local, external input decoupling capacitance with negligible ESR (i.e.: ceramic type)

The voltage source impedance can be modeled as a series $R_{LINE} L_{LINE}$ circuit. The high performance ceramic decoupling capacitors will not significantly damp the network because of their low ESR; therefore in order to guarantee stability the following conditions must be verified:

$$R_{line} > \frac{L_{line}}{(C_{IN_INT} + C_{IN_EXT}) \cdot |r_{EQ_IN}|} \quad (13)$$

$$R_{line} \ll |r_{EQ_IN}| \quad (14)$$

It is critical that the line source impedance be at least an octave lower than the converter's dynamic input resistance (14). However, R_{LINE} cannot be made arbitrarily low otherwise equation (13) is violated and the system will show instability, due to under-damped RLC input network.

Inductive source and local, external input decoupling capacitance with significant R_{CIN_EXT} ESR (i.e.: electrolytic type)

In order to simplify the analysis in this case, the voltage source impedance can be modeled as a simple inductor L_{LINE} . Notice that, the high performance ceramic capacitors C_{IN_INT} within the PRM should be included in the external electrolytic capacitance value for this purpose. The stability criteria will be

$$|r_{EQ_IN}| > R_{CIN_EXT} \quad (15)$$

$$\frac{L_{line}}{C_{IN_EXT} \cdot R_{CIN_EXT}} < |r_{EQ_IN}| \quad (16)$$

Equation (16) shows that if the aggregate ESR is too small – for example by using very high quality input capacitors (C_{IN_EXT}) – the system will be under-damped and may even become destabilized. Again, an octave of design margin in satisfying (15) should be considered the minimum.

Layout Considerations

Application Note AN:005 details board layout recommendations using V•I Chip components, with details on good power connections, reducing EMI, and shielding of control signals and techniques to reference them to SGND. Avoid routing control signals (ENABLE, TRIM, AL etc.) directly underneath the PRM. It is critical that all control signals (aside from VC and VT) are referenced to SGND, both for routing and for pull-down and bypassing purposes. VC and VT provide control and feedback from a VTM, and must be referenced to –OUT of the PRM (-IN of the VTM) SGND is connected to –IN internally to the PRM. SGND should not be tied to any other ground in the system.

Input Fuse Recommendations

A fuse should be incorporated at the input to each PRM, in series with the +IN pin. A 15A or smaller input fuse (Littlefuse® NANO²® 451/453 series) is required to safety agency conditions of acceptability. Always ascertain and observe the safety, regulatory, or other agency specifications that apply to your specific application.

Thermal Considerations

V•Ichip™ products are multi-chip modules whose temperature distribution varies greatly for each part number as well as with the input / output conditions, thermal management and environmental conditions. Maintaining the top of the PRM48A[x]480[y]400A00 case to less than 100°C will keep all junctions within the V•I Chip module below 125°C for most applications. The percent of total heat dissipated through the top surface versus through the J-lead is entirely dependent on the particular mechanical and thermal environment. The heat dissipated through the top surface is typically 60%. The heat dissipated through the J-lead onto the PCB board surface is typically 40%. Use 100% top surface dissipation when designing for a conservative cooling solution.

It is not recommended to use a V•I Chip module for an extended period of time at full load without proper heat sinking.

PRODUCT OUTLINE DRAWING AND RECOMMENDED LAND PATTERN – SMD(F)

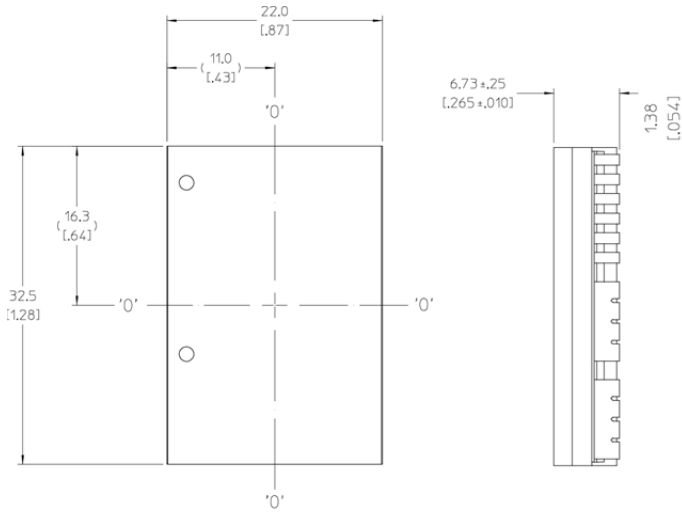

TOP VIEW (COMPONENT SIDE)

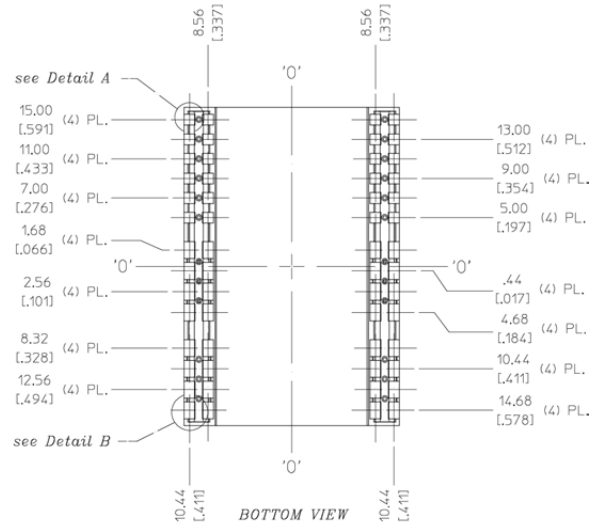

BOTTOM VIEW

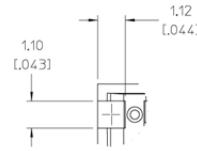
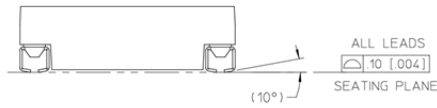

Detail A
Scale 10:1
(24) PL.

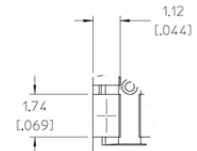

Detail B
Scale 10:1
(32) PL.

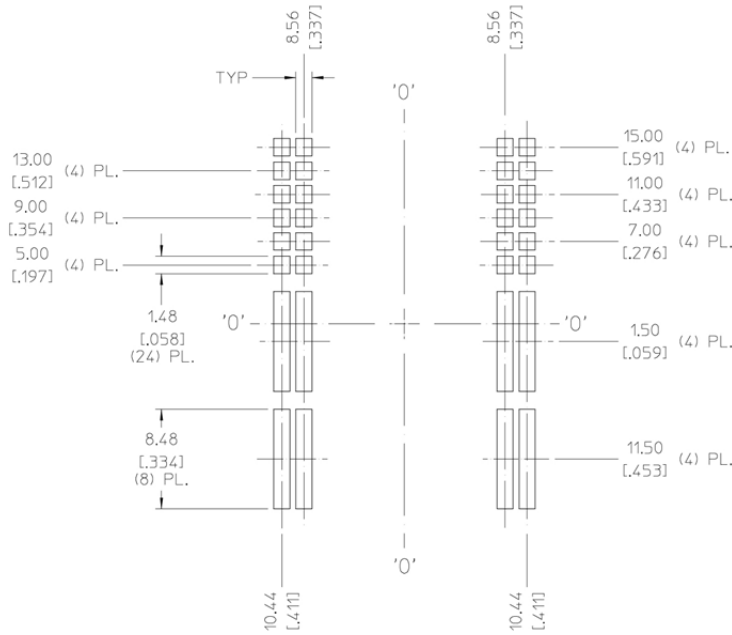

RECOMMENDED LAND PATTERN
(COMPONENT SIDE SHOWN)

PRODUCT OUTLINE DRAWING AND RECOMMENDED LAND PATTERN – THROUGH HOLE(T)

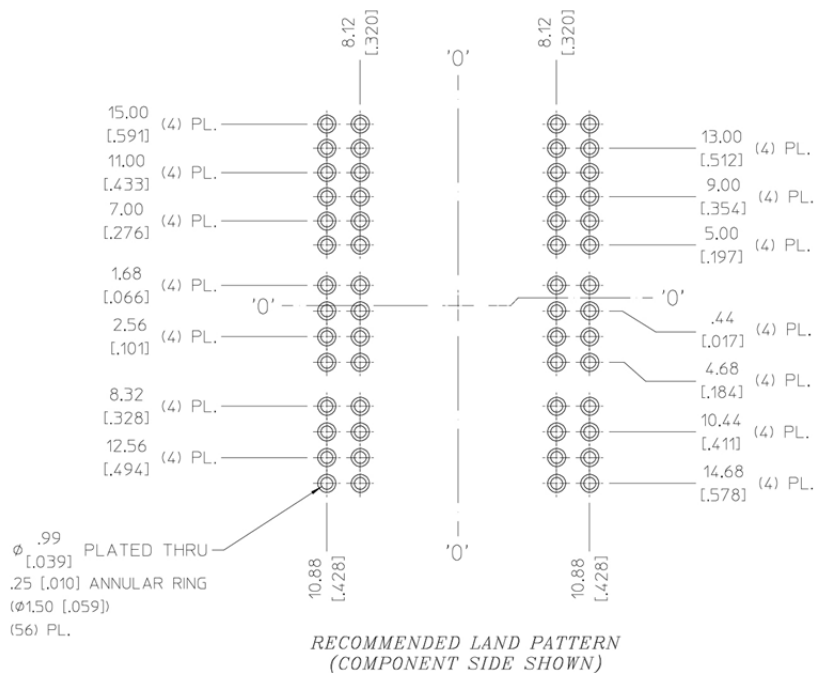
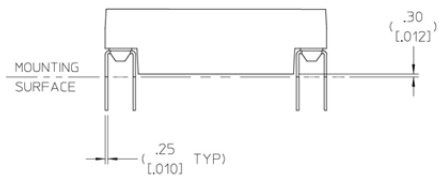
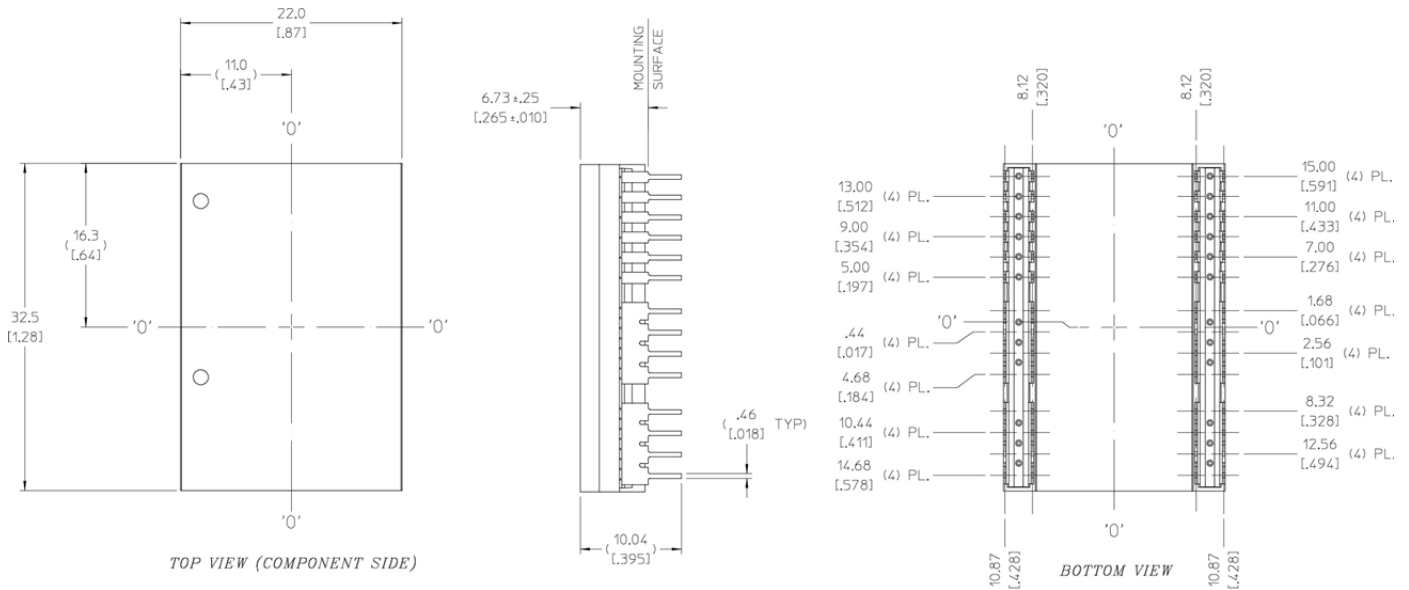

REVISION HISTORY

Revision	Date	Description	Page Number(s)
1.0	11/12/12	Final approved datasheet for initial release.	n/a

Vicor's comprehensive line of power solutions includes high density AC-DC and DC-DC modules and accessory components, fully configurable AC-DC and DC-DC power supplies, and complete custom power systems.

Information furnished by Vicor is believed to be accurate and reliable. However, no responsibility is assumed by Vicor for its use. Vicor makes no representations or warranties with respect to the accuracy or completeness of the contents of this publication. Vicor reserves the right to make changes to any products, specifications, and product descriptions at any time without notice. Information published by Vicor has been checked and is believed to be accurate at the time it was printed; however, Vicor assumes no responsibility for inaccuracies. Testing and other quality controls are used to the extent Vicor deems necessary to support Vicor's product warranty. Except where mandated by government requirements, testing of all parameters of each product is not necessarily performed.

Specifications are subject to change without notice.

Vicor's Standard Terms and Conditions

All sales are subject to Vicor's Standard Terms and Conditions of Sale, which are available on Vicor's webpage or upon request.

Product Warranty

In Vicor's standard terms and conditions of sale, Vicor warrants that its products are free from non-conformity to its Standard Specifications (the "Express Limited Warranty"). This warranty is extended only to the original Buyer for the period expiring two (2) years after the date of shipment and is not transferable.

UNLESS OTHERWISE EXPRESSLY STATED IN A WRITTEN SALES AGREEMENT SIGNED BY A DULY AUTHORIZED VICOR SIGNATORY, VICOR DISCLAIMS ALL REPRESENTATIONS, LIABILITIES, AND WARRANTIES OF ANY KIND (WHETHER ARISING BY IMPLICATION OR BY OPERATION OF LAW) WITH RESPECT TO THE PRODUCTS, INCLUDING, WITHOUT LIMITATION, ANY WARRANTIES OR REPRESENTATIONS AS TO MERCHANTABILITY, FITNESS FOR PARTICULAR PURPOSE, INFRINGEMENT OF ANY PATENT, COPYRIGHT, OR OTHER INTELLECTUAL PROPERTY RIGHT, OR ANY OTHER MATTER.

This warranty does not extend to products subjected to misuse, accident, or improper application, maintenance, or storage. Vicor shall not be liable for collateral or consequential damage. Vicor disclaims any and all liability arising out of the application or use of any product or circuit and assumes no liability for applications assistance or buyer product design. Buyers are responsible for their products and applications using Vicor products and components. Prior to using or distributing any products that include Vicor components, buyers should provide adequate design, testing and operating safeguards.

Vicor will repair or replace defective products in accordance with its own best judgment. For service under this warranty, the buyer must contact Vicor to obtain a Return Material Authorization (RMA) number and shipping instructions. Products returned without prior authorization will be returned to the buyer. The buyer will pay all charges incurred in returning the product to the factory. Vicor will pay all reshipment charges if the product was defective within the terms of this warranty.

Life Support Policy

VICOR'S PRODUCTS ARE NOT AUTHORIZED FOR USE AS CRITICAL COMPONENTS IN LIFE SUPPORT DEVICES OR SYSTEMS WITHOUT THE EXPRESS PRIOR WRITTEN APPROVAL OF THE CHIEF EXECUTIVE OFFICER AND GENERAL COUNSEL OF VICOR CORPORATION. As used herein, life support devices or systems are devices which (a) are intended for surgical implant into the body, or (b) support or sustain life and whose failure to perform when properly used in accordance with instructions for use provided in the labeling can be reasonably expected to result in a significant injury to the user. A critical component is any component in a life support device or system whose failure to perform can be reasonably expected to cause the failure of the life support device or system or to affect its safety or effectiveness. Per Vicor Terms and Conditions of Sale, the user of Vicor products and components in life support applications assumes all risks of such use and indemnifies Vicor against all liability and damages.

Intellectual Property Notice

Vicor and its subsidiaries own Intellectual Property (including issued U.S. and Foreign Patents and pending patent applications) relating to the products described in this data sheet. No license, whether express, implied, or arising by estoppel or otherwise, to any intellectual property rights is granted by this document. Interested parties should contact Vicor's Intellectual Property Department.

The products described on this data sheet are protected by the following U.S. Patents Numbers:
5,945,130; 6,403,009; 6,710,257; 6,911,848; 6,930,893; 6,934,166; 6,940,013; 6,969,909; 7,038,917;
7,145,186; 7,166,898; 7,187,263; 7,202,646; 7,361,844; D496,906; D505,114; D506,438; D509,472; and for
use under 6,975,098 and 6,984,965.

Vicor Corporation
25 Frontage Road
Andover, MA, USA 01810
Tel: 800-735-6200
Fax: 978-475-6715

email

Customer Service: custserv@vicorpower.com
Technical Support: apps@vicorpower.com