

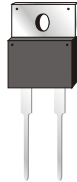

FEATURES

- Plastic package has Underwriters Laboratory Flammability Classification 94V-0
- Metal silicon junction ,majority carrier conduction
- Guard ring for overvoltage protection
- Low power loss ,high efficiency
- High current capability ,Low forward voltage drop
- Single rectifier construction
- High surge capability
- For use in low voltage ,high frequency inverters, free wheeling ,and polarity protection applications
- High temperature soldering guaranteed:260°C/10 seconds, 0.25"(6.35mm)from case



TO-220AC

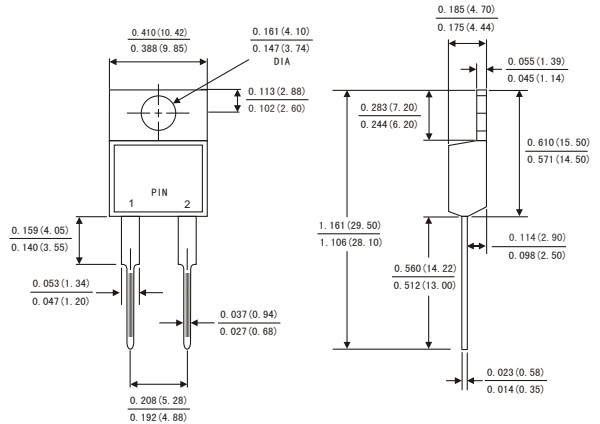

MECHANICAL DATA

- Case: JEDEC TO-220AC molded plastic body
- Terminals: Lead solderable per MIL-STD-750,method 2026
- Polarity: As marked
- Mounting Position: Any
- Weight: 0.08ounce, 2.24 gram

Dimensions in inches and (millimeters)

MAXIMUM RATINGS AND ELECTRICAL CHARACTERISTICS

(Ratings at 25°C ambient temperature unless otherwise specified ,Single phase ,half wave ,resistive or inductive load. For capacitive load,derate by 20%.)

	Symbols	SR 1020	SR 1030	SR 1040	SR 1050	SR 1060	SR 1080	SR 10100	SR 10150	SR 10200	Units
Maximum repetitive peak reverse voltage	V_{RRM}	20	30	40	50	60	80	100	150	200	Volts
Maximum RMS voltage	V_{RMS}	14	21	28	35	42	56	70	105	140	Volts
Maximum DC blocking voltage	V_{DC}	20	30	40	50	60	80	100	150	200	Volts
Maximum average forward rectified current (see Fig.1)	$I_{(AV)}$	10.0									Amps
Peak forward surge current 8.3ms single half sine-wave superimposed on rated load (JEDEC method)	I_{FSM}	150.0									Amps
Maximum instantaneous forward voltage at 10.0 A(Note 1)	V_F	0.60			0.75		0.85		0.90	0.95	Volts
Maximum instantaneous reverse current at rated DC blocking voltage(Note 1)	$T_a = 25^\circ\text{C}$	0.2									mA
	$T_a = 125^\circ\text{C}$	15			50						
Typical thermal resistance (Note 2)	$R_{\theta JC}$	2.5									°C/W
Operating junction temperature range	T_J	-65 to +150									°C
Storage temperature range	T_{STG}	-65 to +150									°C

- Notes: 1.Pulse test: 300 μ s pulse width,1% duty cycle
2.Thermal resistance from junction to case



FIG.1-FORWARD CURRENT DERATING CURVE

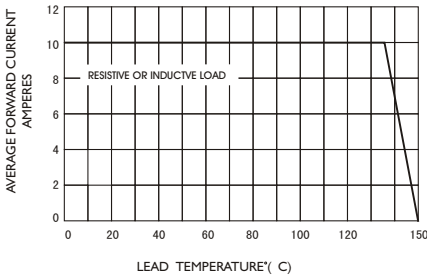

FIG.2-MAXIMUM NON-REPETITIVE PEAK FORWARD SURGE CURRENT

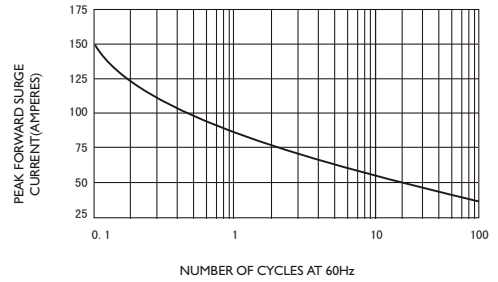

FIG.3-TYPICAL INSTANTANEOUS FORWARD CHARACTERISTICS

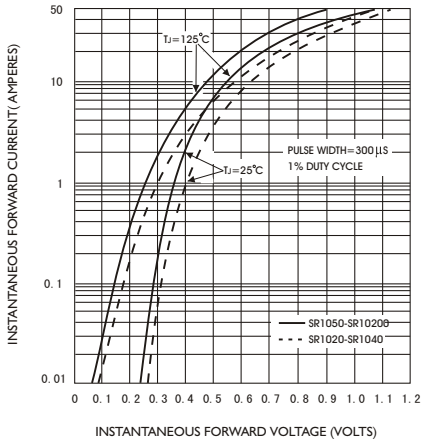

FIG.4-TYPICAL REVERSE CHARACTERISTICS

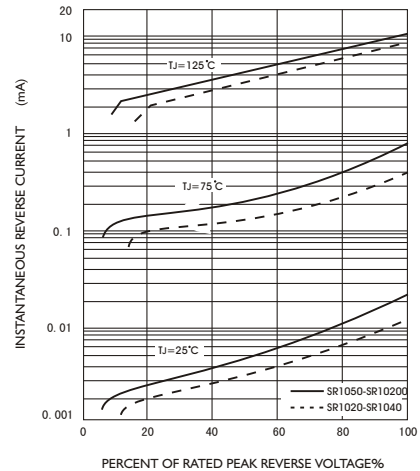

FIG.5-TYPICAL JUNCTION CAPACITANCE

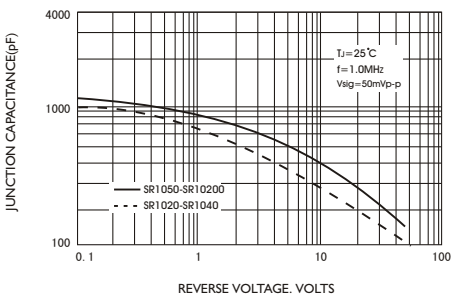

FIG.6-TYPICAL TRANSIENT THERMAL IMPEDANCE

