

GSC355-HYB2150

2.15GHz Band 90Deg. Chip Hybrid Coupler

[Inquire](#)

Compact & High power capability.

Application

for RF power amplifier (Base station)

Characteristics**GSC355-HYB2150**

Impedance	50 ohm Nominal
Frequency Range	2100-2200MHz
Average Coupling Insertion Loss	0.2dB max (Typ. 0.16dB)
Amplitude Level Balance	0.2dB max. (S21-S31)
Phase Balance	90+/-2 Degrees
V.S.W.R	1.18 max
Isolation	23dB min.
Input Power	200W Avg/CW
Operating Temperature	-40 up to 125 Deg.C
Storage Temperature	-40 up to 85 Deg.C (-20 up to 35 Deg.C for tape and reel materials)

Number of ordered pieces

1000pcs/Reel

Dimensions

Dimension (Unit : mm)

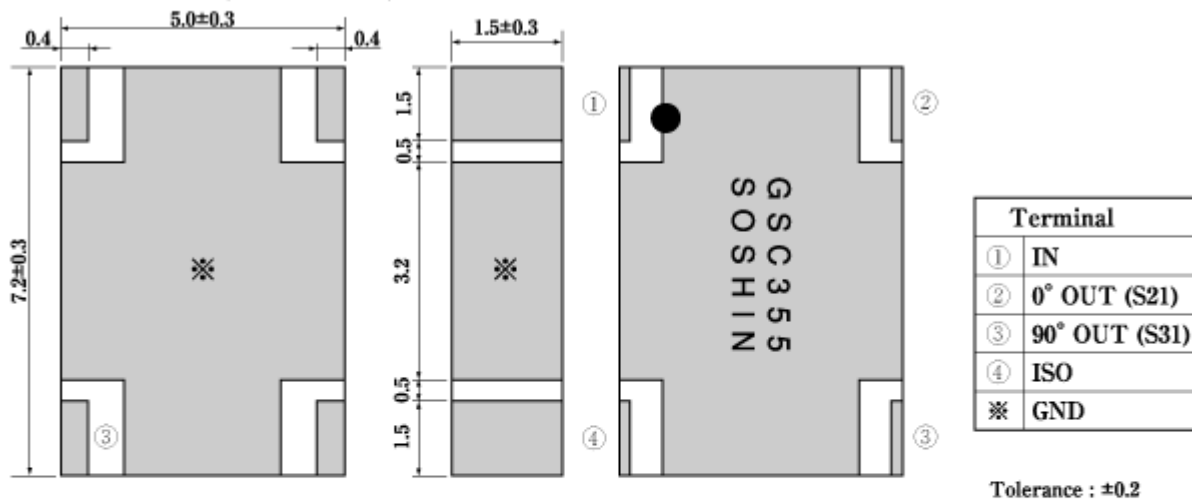

Measurement circuit

1. Note

Heat Dissipation

Please let me emit sufficient heat so that product surface temperature may become quantity fewer than 120deg, and use it.

2. Measuring Circuit

All items of electrical characteristics shall be measured on test fixture which is decided by supplier.

Network analyzer

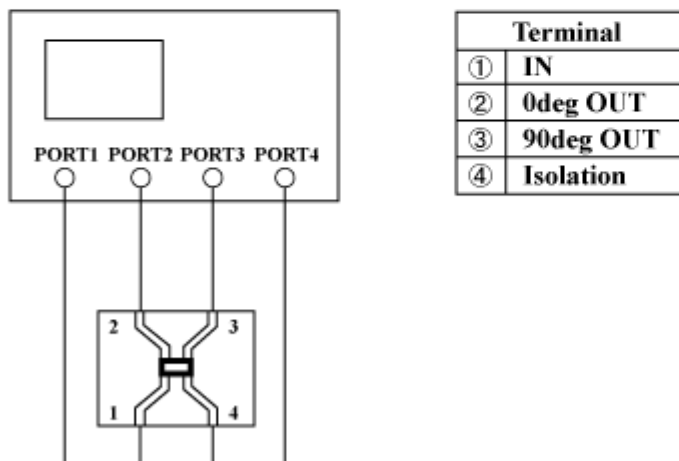

Recommended pattern (Unit:mm)

Measurement board pattern

(Example : $\epsilon = 2.6$, $t = 0.8\text{mm}$ Double side printed circuit board)

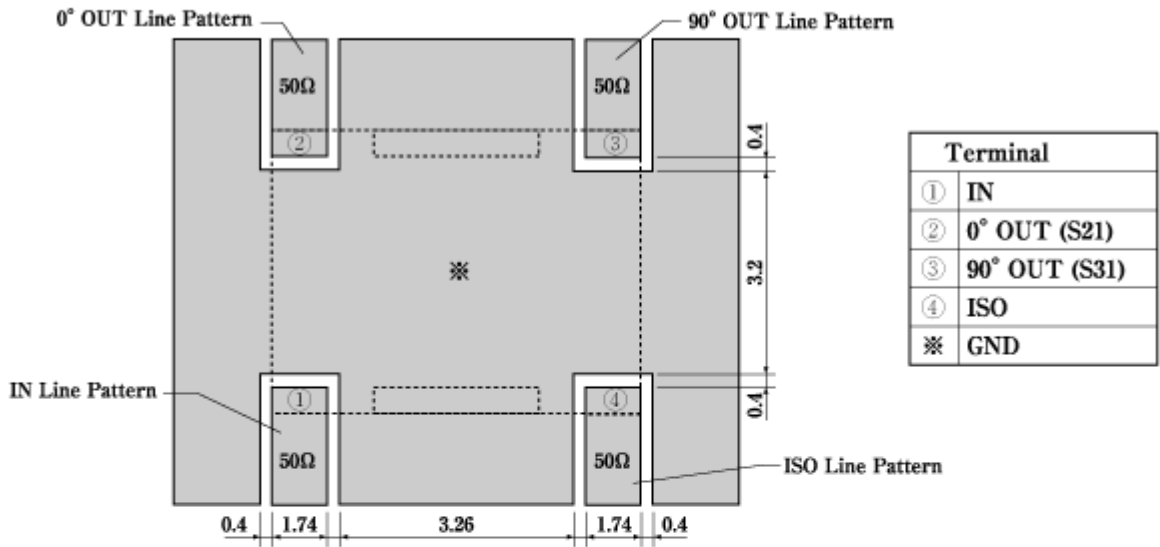

Resist pattern

