

Features

- ✧ High efficiency, low VF
- ✧ High current capability
- ✧ High reliability
- ✧ High surge current capability
- ✧ Low power loss
- ✧ For use in low voltage, high frequency inverter, free wheeling, and polarity protection application
- ✧ Green compound with suffix "G" on packing code & prefix "G" on datecode.



Mechanical Data

- ✧ Cases: TO-220AB Molded plastic
- ✧ Epoxy: UL 94V-0 rate flame retardant
- ✧ Terminals: Pure tin plated, lead free, solderable per MIL-STD-202, Method 208 guaranteed
- ✧ Polarity: As marked
- ✧ High temperature soldering guaranteed: 260°C/10 seconds 16", (4.06mm) from case.
- ✧ Weight: 1.90 grams

Ordering Information(example)

Part No.	Package	Packing	Packing code	Packing code (Green)
SF1601G	TO-220AB	50 / TUBE	C0	C0G

Maximum Ratings and Electrical Characteristics

Rating at 25 °C ambient temperature unless otherwise specified.

Parameter	Symbol	SF	SF	SF	SF	SF	SF	SF	SF	Units
		1601G	1602G	1603G	1604G	1605G	1606G	1607G	1608G	
Maximum Recurrent Peak Reverse Voltage	V_{RRM}	50	100	150	200	300	400	500	600	V
Maximum RMS Voltage	V_{RMS}	35	70	105	140	210	280	350	420	V
Maximum DC Blocking Voltage	V_{DC}	50	100	150	200	300	400	500	600	V
Maximum Average Forward Rectified Current	$I_{F(AV)}$	16								A
Peak Forward Surge Current, 8.3 ms Single Half Sine-wave Superimposed on Rated Load (JEDEC method)	I_{FSM}	125								A
Maximum Instantaneous Forward Voltage (Note 1) @ 8 A	V_F	0.975			1.3		1.7			V
Maximum DC Reverse Current @ $T_A=25\text{ }^\circ\text{C}$ at Rated DC Blocking Voltage @ $T_A=100\text{ }^\circ\text{C}$	I_R	10				400				uA
Maximum Reverse Recovery Time (Note 2)	T_{rr}	35								nS
Typical Junction Capacitance (Note 3)	C_j	80				60				pF
Typical Thermal Resistance	$R_{\theta JC}$	1.5								$^\circ\text{C/W}$
Operating Temperature Range	T_J	- 65 to + 150								$^\circ\text{C}$
Storage Temperature Range	T_{STG}	- 65 to + 150								$^\circ\text{C}$

Note 1: Pulse Test with PW=300 usec, 1% Duty Cycle

Note 2: Reverse Recovery Test Conditions: $I_F=0.5\text{A}$, $I_R=1.0\text{A}$, $I_{RR}=0.25\text{A}$.

Note 3: Measured at 1 MHz and Applied Reverse Voltage of 4.0V D.C.

RATINGS AND CHARACTERISTIC CURVES (SF1601G THRU SF1608G)

FIG. 1- MAXIMUM FORWARD CURRENT DERATING CURVE

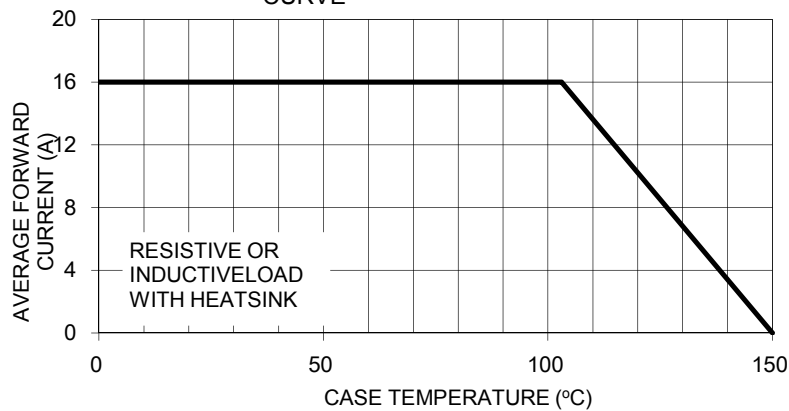

FIG. 2- TYPICAL REVERSE CHARACTERISTICS PER LEG

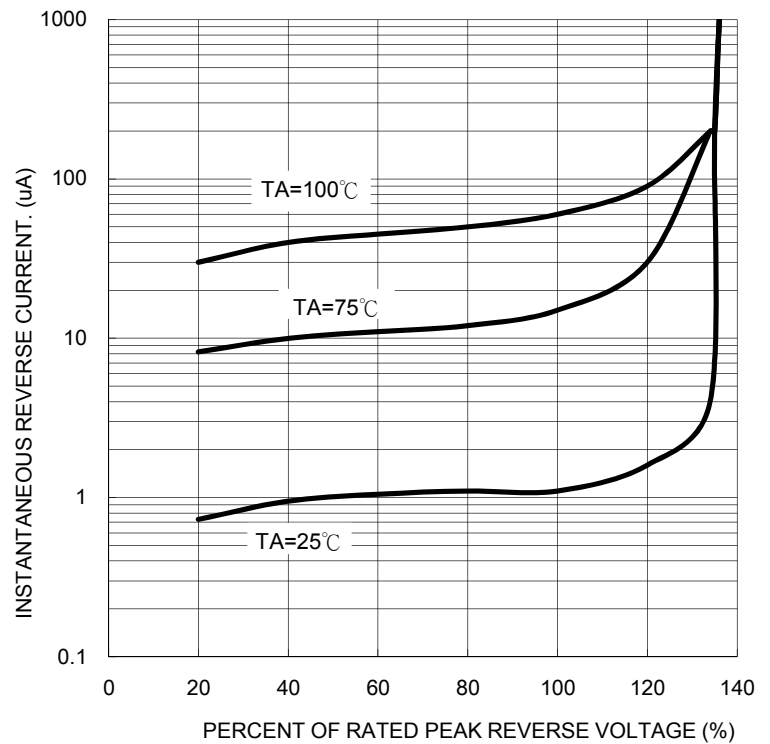

FIG. 3- MAXIMUM NON-REPETITIVE FORWARD SURGE CURRENT PER LEG

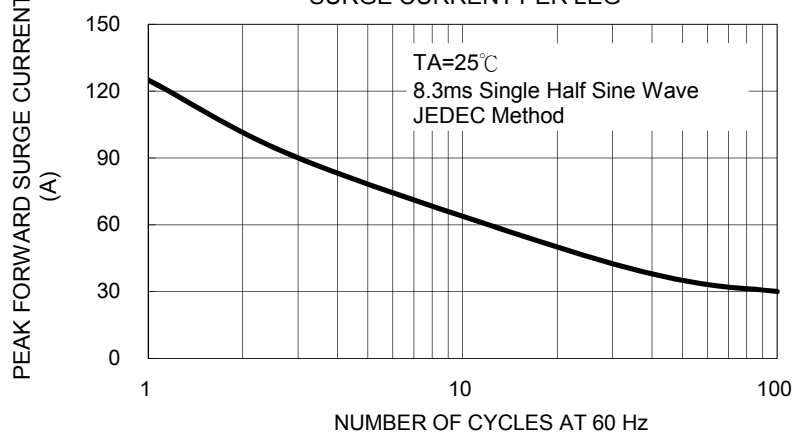

FIG. 5- TYPICAL FORWARD CHARACTERISTICS PER LEG

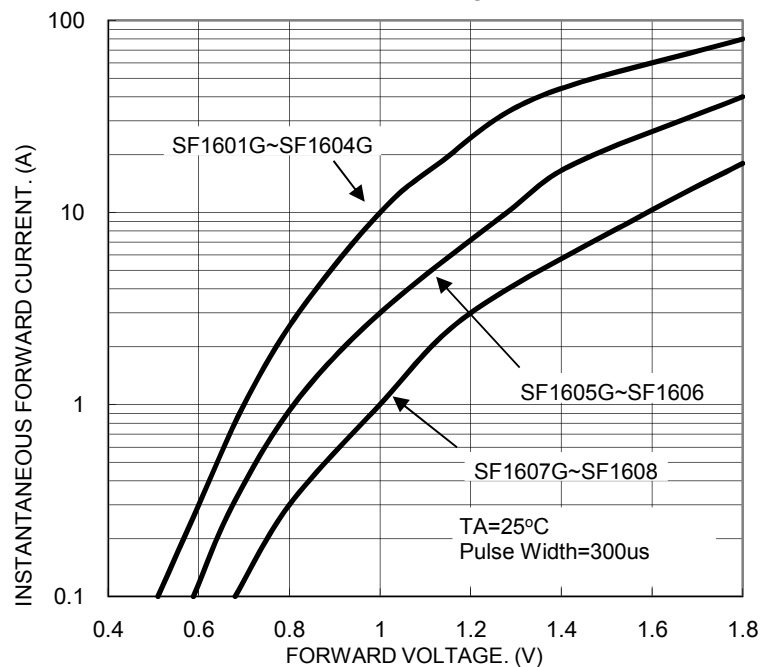

FIG. 4- TYPICAL JUNCTION CAPACITANCE PER LEG

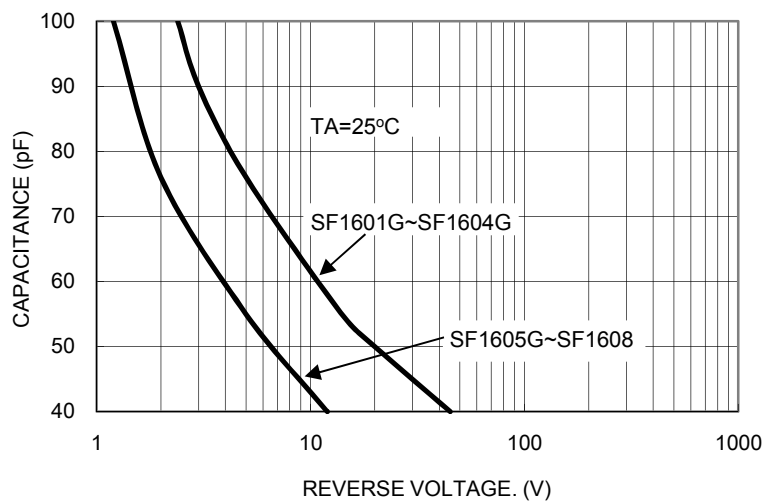
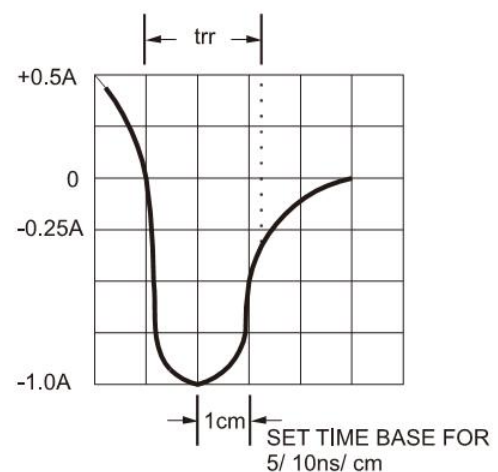
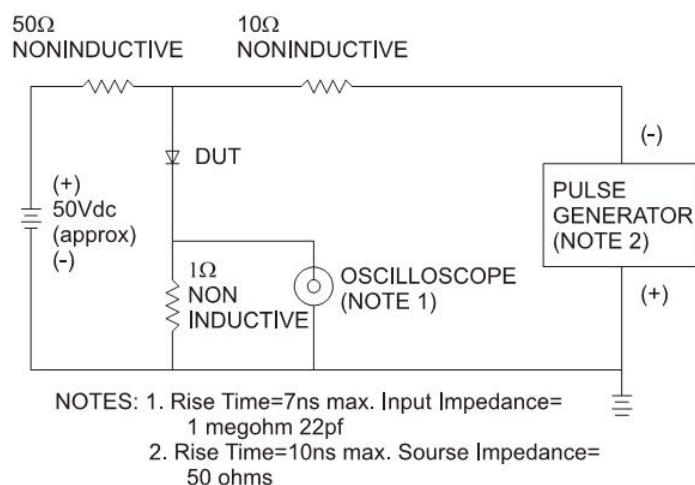

FIG. 6- REVERSE RECOVERY TIME CHARACTERISTIC AND TEST CIRCUIT DIAGRAM



Ordering information

Part No.	Package	BULK Packing	Packing code	Packing code (Green)
SF160xG	TO-220AB	50 / TUBE	C0	C0G

Note: "x" is Device Code from "1" thru "8".

Dimensions

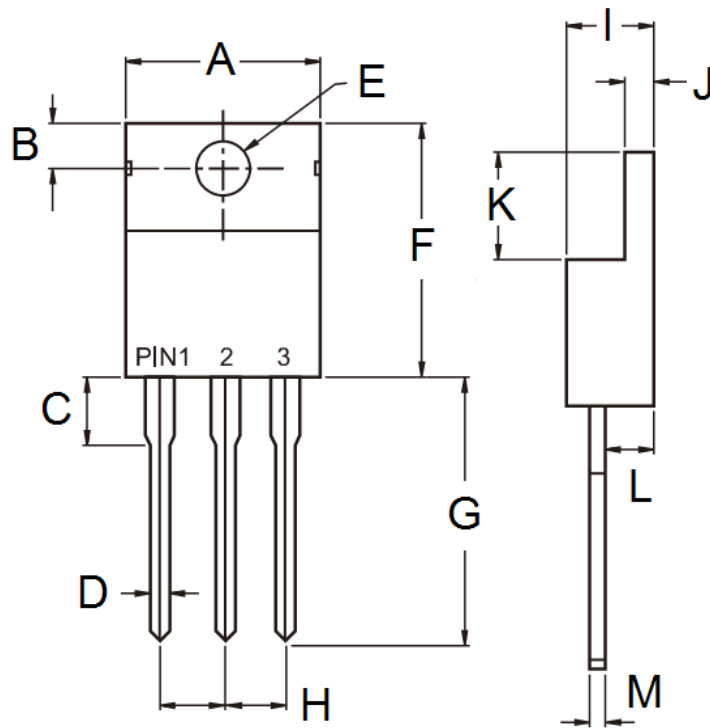

DIM.	Unit(mm)		Unit(inch)	
	Min	Max	Min	Max
A	-	10.50	-	0.413
B	2.62	3.44	0.103	0.135
C	2.80	4.20	0.110	0.165
D	0.68	0.94	0.027	0.037
E	3.54	4.00	0.139	0.157
F	14.60	16.00	0.575	0.630
G	13.19	14.79	0.519	0.582
H	2.41	2.67	0.095	0.105
I	4.42	4.76	0.174	0.187
J	1.14	1.40	0.045	0.055
K	5.84	6.86	0.230	0.270
L	2.20	2.80	0.087	0.110
M	0.35	0.64	0.014	0.025

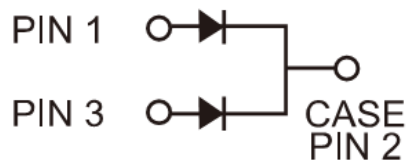

Marking Diagram



P/N = Specific Device Code
 G = Green Compound
 YWW = Date Code