

Features

- High resistance to heat and humidity
- Resistance to mechanical shock and pressure
- Accurate dimensions for automatic surface mounting
- Wide inductance range (1.0 nH to 1000 μH)
- RoHS compliant*

Applications

- Mobile phones
- Cellular phones
- CTV, VCR, HIC, FDD

CM45, CM32, CM25, CM20, CM16, CM10 SMT Chip Inductors

General Specifications

Temperature Rise20 °C max.
Ambient Temperature 80 °C max.
Operating Temperature	
CM10, CM16, CM20, CM25, CM32-40 °C to +100 °C
CM45-40 °C to +125 °C
Storage Temperature	
CM10, CM16, CM20, CM25, CM32-40 °C to +100 °C
CM45-40 °C to +125 °C
Resistance to Soldering Heat260 °C, 5 seconds

Materials

Core Material	
CM10, CM16Alumina Ceramic
CM20Polymer 10 nH to 1000 nH
CM25Polymer 10 nH to 180 nH
CM32Polymer 47 nH to 180 nH
Ferrite Core	
CM25220 nH to 100 μH
CM32220 nH +
CM45All
Coil Type	
CM10, CM16Copper plating
CM20, CM25, CM32, CM45Copper wire
Enclosure	
CM10, CM16Resin
CM20, CM25, CM32, CM45Epoxy resin
Terminal	
CM10, CM16, CM20, CM25, CM32, CM45Sn

Product Dimensions

CM100505, CM160808

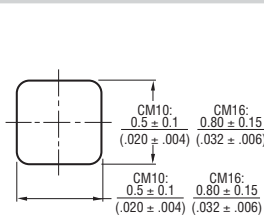
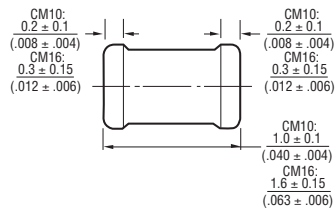

CM201212

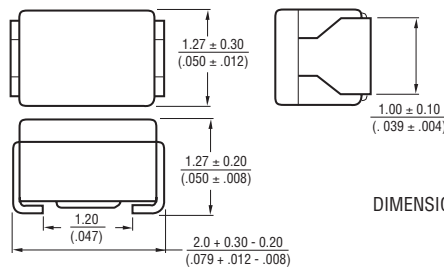

DIMENSIONS ARE: $\frac{\text{MM}}{\text{(INCHES)}}$

CM252016

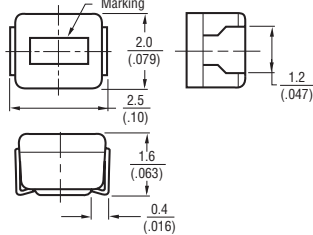

CM322522

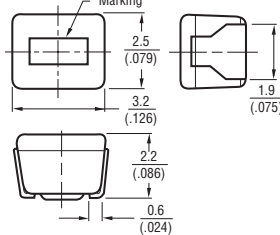

CM453232

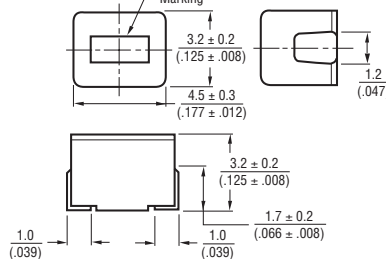

Recommended Land Pattern Dimensions

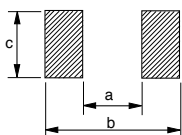

Model	a	b	c
CM10	0.5 to 0.6 (.019 to .023)	1.5 to 1.7 (.059 to .067)	0.5 to 0.6 (.019 to .023)
CM16	0.8 to 1.0 (.032 to .039)	2.0 to 2.6 (.079 to .102)	0.7 to 0.9 (.028 to .035)
CM20	1.0 to 1.2 (.039 to .047)	3.0 to 3.8 (.118 to .150)	0.9 to 1.3 (.028 to .051)
CM25	1.4 to 1.5 (.055 to .059)	3.5 to 4.0 (.138 to .157)	1.2 to 1.6 (.047 to .063)
CM32	1.6 to 2.0 (.063 to .079)	4.0 to 4.6 (.157 to .181)	1.9 to 2.4 (.075 to .094)
CM45	2.4 to 2.6 (.094 to .102)	5.5 to 6.0 (.217 to .236)	2.0 to 3.0 (.079 to .118)

*RoHS Directive 2002/95/EC Jan 27, 2003 including Annex. Specifications are subject to change without notice. Customers should verify actual device performance in their specific applications.

CM45, CM32, CM25, CM20, CM16, CM10 SMT Chip Inductors

BOURNS®

Packaging Specifications

CM10



CM16, CM20, CM25, CM32



CM45



Model	A	B	W	F	E	P1	P2	P3	D0 Dia.	D1 Dia.	t1	t2
CM10	0.71 (.027)	1.21 (.047)	8.00 (.315)	3.50 (.138)	1.75 (.069)	4.00 (.157)	2.00 (.079)	4.00 (.157)	1.50 (.059)	—	—	0.66 (.026)
CM16	1.00 (.039)	1.80 (.071)	8.00 (.315)	3.50 (.138)	1.75 (.069)	4.00 (.157)	2.00 (.079)	4.00 (.157)	1.50 (.059)	0.60 (.024)	0.27 (.011)	1.20 (.047)
CM20	1.45 (.057)	2.25 (.089)	8.00 (.315)	3.50 (.138)	1.75 (.069)	4.00 (.157)	2.00 (.079)	4.00 (.157)	1.50 (.059)	1.00 (.039)	0.25 (.010)	1.55 (.061)
CM25	2.40 (.094)	2.90 (.114)	8.00 (.315)	3.50 (.138)	1.75 (.069)	4.00 (.157)	2.00 (.079)	4.00 (.157)	1.50 (.059)	1.10 (.043)	0.25 (.010)	1.85 (.073)
CM32	2.80 (.110)	3.60 (.142)	8.00 (.315)	3.50 (.138)	1.75 (.069)	4.00 (.157)	2.00 (.079)	4.00 (.157)	1.50 (.059)	—	0.25 (.010)	2.40 (.094)
CM45	3.60 (.142)	4.90 (.193)	12.00 (.472)	5.50 (.217)	1.75 (.069)	8.00 (.315)	2.00 (.079)	4.00 (.157)	1.50 (.059)	—	0.30 (.012)	3.50 (.138)

Reel Dimensions

Model	A	B	C	D	E	W
CM10 ~ CM32	178 (7.008)	60 min.	13 (.512)	21 (.827)	2 (.079)	9 (.354)
CM45	178 (7.008)	60 min.	13 (.512)	21 (.827)	2 (.079)	13 (.512)

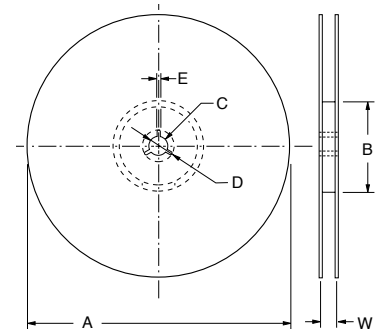

Packaging

Model	Quantity	Weight
CM10	10000 pcs	150 g
CM16	3000 pcs	90 g
CM20	3000 pcs	90 g

Model	Quantity	Weight
CM25	2000 pcs	100 g
CM32	2000 pcs	190 g
CM45	500 pcs	100 g

Soldering Profiles

CM16, CM10

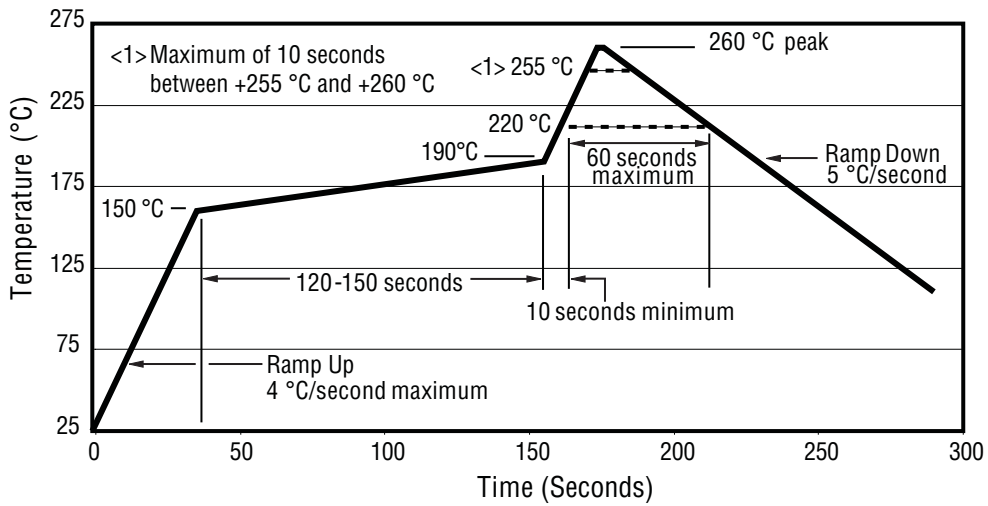

CM45, CM32, CM25, CM20

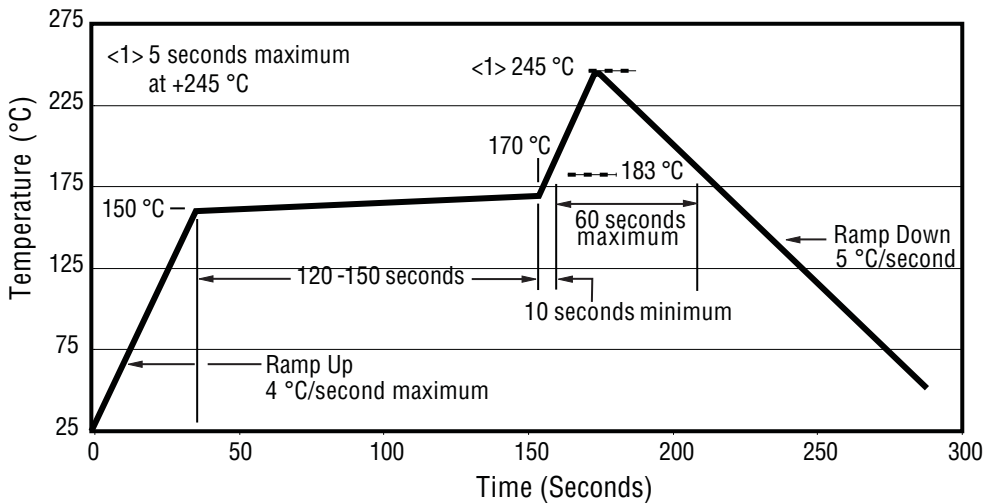

Chip Inductors - CM453232 Series Wirewound

BOURNS®

RoHS Compliant 1812 Size Part Number	Inductance μH	Std. Tolerance	Std. Tol. Code	1/2 Tolerance	1/2 Tol. Code	Q min.	Test Freq. MHz	SRF min. MHz	RDC ohm max	IDC mA max
CM453232-R10<1>L	0.10	±20 %	M	±10 %	K	35	25.2	300	0.18	800
CM453232-R12<1>L	0.12	±20 %	M	±10 %	K	35	25.2	280	0.2	770
CM453232-R15<1>L	0.15	±20 %	M	±10 %	K	35	25.2	250	0.22	730
CM453232-R18<1>L	0.18	±20 %	M	±10 %	K	35	25.2	220	0.24	700
CM453232-R22<1>L	0.22	±20 %	M	±10 %	K	40	25.2	200	0.25	665
CM453232-R27<1>L	0.27	±20 %	M	±10 %	K	40	25.2	180	0.26	635
CM453232-R33<1>L	0.33	±20 %	M	±10 %	K	40	25.2	165	0.28	605
CM453232-R39<1>L	0.39	±20 %	M	±10 %	K	40	25.2	150	0.30	575
CM453232-R47<1>L	0.47	±20 %	M	±10 %	K	40	25.2	145	0.32	545
CM453232-R56<1>L	0.56	±20 %	M	±10 %	K	40	25.2	140	0.36	520
CM453232-R68<1>L	0.68	±20 %	M	±10 %	K	40	25.2	135	0.40	500
CM453232-R82<1>L	0.82	±20 %	M	±10 %	K	40	25.2	130	0.45	475
CM453232-1R0<1>L	1.0	±10 %	K	±5 %	J	50	7.96	100	0.50	450
CM453232-1R2<1>L	1.2	±10 %	K	±5 %	J	50	7.96	80	0.55	430
CM453232-1R5<1>L	1.5	±10 %	K	±5 %	J	50	7.96	70	0.60	410
CM453232-1R8<1>L	1.8	±10 %	K	±5 %	J	50	7.96	60	0.65	390
CM453232-2R2<1>L	2.2	±10 %	K	±5 %	J	50	7.96	55	0.70	380
CM453232-2R7<1>L	2.7	±10 %	K	±5 %	J	50	7.96	50	0.75	370
CM453232-3R3<1>L	3.3	±10 %	K	±5 %	J	50	7.96	45	0.80	355
CM453232-3R9<1>L	3.9	±10 %	K	±5 %	J	50	7.96	40	0.90	330
CM453232-4R7<1>L	4.7	±10 %	K	±5 %	J	50	7.96	35	1.00	315
CM453232-5R6<1>L	5.6	±10 %	K	±5 %	J	50	7.96	33	1.10	300
CM453232-6R8<1>L	6.8	±10 %	K	±5 %	J	50	7.96	27	1.2	285
CM453232-8R2<1>L	8.2	±10 %	K	±5 %	J	50	7.96	25	1.4	270
CM453232-100<1>L	10	±10 %	K	±5 %	J	50	2.52	20	1.6	250
CM453232-120<1>L	12	±10 %	K	±5 %	J	50	2.52	18	2	225
CM453232-150<1>L	15	±10 %	K	±5 %	J	50	2.52	17	2.5	200
CM453232-180<1>L	18	±10 %	K	±5 %	J	50	2.52	15	2.8	190
CM453232-220<1>L	22	±10 %	K	±5 %	J	50	2.52	13	3.2	180
CM453232-270<1>L	27	±10 %	K	±5 %	J	50	2.52	12	3.6	170
CM453232-330<1>L	33	±10 %	K	±5 %	J	50	2.52	11	4	160
CM453232-390<1>L	39	±10 %	K	±5 %	J	50	2.52	10	4.5	150
CM453232-470<1>L	47	±10 %	K	±5 %	J	50	2.52	10	5	140
CM453232-560<1>L	56	±10 %	K	±5 %	J	50	2.52	9	5.5	135
CM453232-680<1>L	68	±10 %	K	±5 %	J	50	2.52	9	6	130
CM453232-820<1>L	82	±10 %	K	±5 %	J	50	2.52	8	7	120
CM453232-101<1>L	100	±10 %	K	±5 %	J	40	2.52	8	8	110
CM453232-121<1>L	120	±10 %	K	±5 %	J	40	0.796	6	8	110
CM453232-151<1>L	150	±10 %	K	±5 %	J	40	0.796	5	9	105
CM453232-181<1>L	180	±10 %	K	±5 %	J	40	0.796	5	9.5	102
CM453232-221<1>L	220	±10 %	K	±5 %	J	40	0.796	4	10	100
CM453232-271<1>L	270	±10 %	K	±5 %	J	40	0.796	4	12	92
CM453232-331<1>L	330	±10 %	K	±5 %	J	40	0.796	3.5	14	85
CM453232-391<1>L	390	±10 %	K	±5 %	J	40	0.796	3	18	80
CM453232-471<1>L	470	±10 %	K	±5 %	J	40	0.796	3	26	62
CM453232-561<1>L	560	±10 %	K	±5 %	J	30	0.796	3	30	50
CM453232-681<1>L	680	±10 %	K	±5 %	J	30	0.796	3	30	50
CM453232-821<1>L	820	±10 %	K	±5 %	J	30	0.796	2.5	35	30
CM453232-102<1>L	1000	±10 %	K	±5 %	J	30	0.252	2.5	40	30

<1> Enter tolerance code from standard or 1/2 tolerance column. Example: CM453232-1R2KL is standard tolerance; CM453232-1R2JL is 1/2 tolerance.

Specifications are subject to change without notice.
Customers should verify actual device performance in their specific applications.

Chip Inductors - CM322522 Series Wirewound

BOURNS®

RoHS Compliant 1210 Size Part Number	Inductance μH	Std. Tolerance	Std. Tol. Code	1/2 Tolerance	1/2 Tol. Code	Q min.	Test Freq. MHz	SRF min. MHz	RDC ohm max	IDC mA max
CM322522-47NML	0.047	±20 %	M	N/A	N/A	10	100	680	0.20	450
CM322522-56NML	0.056	±20 %	M	N/A	N/A	10	100	600	0.22	420
CM322522-68NML	0.068	±20 %	M	N/A	N/A	10	100	540	0.25	400
CM322522-82NML	0.082	±20 %	M	N/A	N/A	10	100	500	0.27	380
CM322522-R10ML	0.10	±20 %	M	N/A	N/A	10	100	450	0.30	360
CM322522-R12ML	0.12	±20 %	M	N/A	N/A	10	25.2	400	0.67	240
CM322522-R15ML	0.15	±20 %	M	N/A	N/A	10	25.2	350	0.72	230
CM322522-R18ML	0.18	±20 %	M	N/A	N/A	10	25.2	320	0.81	220
CM322522-R22<1>L	0.22	±20 %	M	±10 %	K	25	25.2	230	0.29	360
CM322522-R27<1>L	0.27	±20 %	M	±10 %	K	25	25.2	210	0.32	345
CM322522-R33<1>L	0.33	±20 %	M	±10 %	K	25	25.2	190	0.35	330
CM322522-R39<1>L	0.39	±20 %	M	±10 %	K	25	25.2	175	0.39	305
CM322522-R47<1>L	0.47	±20 %	M	±10 %	K	25	25.2	160	0.44	290
CM322522-R56<1>L	0.56	±20 %	M	±10 %	K	25	25.2	150	0.49	275
CM322522-R68<1>L	0.68	±20 %	M	±10 %	K	25	25.2	135	0.55	260
CM322522-R82<1>L	0.82	±20 %	M	±10 %	K	25	25.2	125	0.61	245
CM322522-1R0<1>L	1.0	±10 %	K	±5 %	J	30	7.96	115	0.69	230
CM322522-1R2<1>L	1.2	±10 %	K	±5 %	J	30	7.96	100	0.75	215
CM322522-1R5<1>L	1.5	±10 %	K	±5 %	J	30	7.96	90	0.75	210
CM322522-1R8<1>L	1.8	±10 %	K	±5 %	J	30	7.96	85	0.82	200
CM322522-2R2<1>L	2.2	±10 %	K	±5 %	J	30	7.96	80	0.95	190
CM322522-2R7<1>L	2.7	±10 %	K	±5 %	J	30	7.96	75	1.1	180
CM322522-3R3<1>L	3.3	±10 %	K	±5 %	J	30	7.96	65	1.2	180
CM322522-3R9<1>L	3.9	±10 %	K	±5 %	J	30	7.96	60	1.3	175
CM322522-4R7<1>L	4.7	±10 %	K	±5 %	J	30	7.96	55	1.5	165
CM322522-5R6<1>L	5.6	±10 %	K	±5 %	J	30	7.96	50	1.6	160
CM322522-6R8<1>L	6.8	±10 %	K	±5 %	J	30	7.96	45	1.8	150
CM322522-8R2<1>L	8.2	±10 %	K	±5 %	J	30	7.96	40	2.0	140
CM322522-100<1>L	10	±10 %	K	±5 %	J	30	2.52	36	2.1	140
CM322522-120<1>L	12	±10 %	K	±5 %	J	30	2.52	33	2.5	125
CM322522-150<1>L	15	±10 %	K	±5 %	J	30	2.52	30	2.8	120
CM322522-180<1>L	18	±10 %	K	±5 %	J	30	2.52	27	3.3	110
CM322522-220<1>L	22	±10 %	K	±5 %	J	30	2.52	25	3.7	105
CM322522-270<1>L	27	±10 %	K	±5 %	J	30	2.52	22	5.0	90
CM322522-330<1>L	33	±10 %	K	±5 %	J	30	2.52	20	5.6	85
CM322522-390<1>L	39	±10 %	K	±5 %	J	30	2.52	20	6.4	80
CM322522-470<1>L	47	±10 %	K	±5 %	J	30	2.52	15	7.0	75
CM322522-560<1>L	56	±10 %	K	±5 %	J	30	2.52	15	8.0	70
CM322522-680<1>L	68	±10 %	K	±5 %	J	30	2.52	15	9.0	65
CM322522-820<1>L	82	±10 %	K	±5 %	J	30	2.52	11	10	60
CM322522-101<1>L	100	±10 %	K	±5 %	J	20	0.796	10	10	60
CM322522-121<1>L	120	±10 %	K	±5 %	J	20	0.796	10	11	55
CM322522-151<1>L	150	±10 %	K	±5 %	J	20	0.796	8	15	50
CM322522-181<1>L	180	±10 %	K	±5 %	J	20	0.796	7	17	50
CM322522-221<1>L	220	±10 %	K	±5 %	J	20	0.796	7	21	45

Tighter tolerance available on request. Consult factory.

NOTE: 47 nH to 180 nH 'air core' / 220 nH to 220 μH 'ferrite core'

<1>Enter tolerance code from standard or 1/2 tolerance column. Example: CM322522-1R0KL is standard tolerance; CM322522-1R0JL is 1/2 tolerance.

Specifications are subject to change without notice.
Customers should verify actual device performance in their specific applications.

Chip Inductors - CM252016 Series Wirewound

BOURNS®

RoHS Compliant 1008 Size Part Number	Inductance μH	Tolerance	Q min.	Test Frequency MHz	SRF min. MHz	RDC ohm max	IDC mA max
CM252016-10NKL	0.010	±10 %	10	100	2500	0.32	280
CM252016-12NKL	0.012	±10 %	10	100	2200	0.34	270
CM252016-15NKL	0.015	±10 %	10	100	1800	0.38	255
CM252016-18NKL	0.018	±10 %	10	100	1550	0.4	250
CM252016-22NKL	0.022	±10 %	15	100	1350	0.43	240
CM252016-27NKL	0.027	±10 %	15	100	1150	0.47	230
CM252016-33NKL	0.033	±10 %	15	100	1000	0.51	220
CM252016-39NKL	0.039	±10 %	15	100	890	0.55	215
CM252016-47NKL	0.047	±10 %	15	100	770	0.59	205
CM252016-56NKL	0.056	±10 %	15	100	670	0.63	200
CM252016-68NKL	0.068	±10 %	15	100	590	0.68	190
CM252016-82NKL	0.082	±10 %	15	100	520	0.73	185
CM252016-R10KL	0.10	±10 %	10	25.2	460	0.80	175
CM252016-R12KL	0.12	±10 %	10	25.2	400	0.87	170
CM252016-R15KL	0.15	±10 %	10	25.2	340	0.98	160
CM252016-R18KL	0.18	±10 %	10	25.2	300	1.05	155
CM252016-R22ML	0.22	±20 %	25	25.2	230	0.70	190
CM252016-R27ML	0.27	±20 %	25	25.2	210	0.75	180
CM252016-R33ML	0.33	±20 %	25	25.2	190	0.85	170
CM252016-R39ML	0.39	±20 %	25	25.2	175	0.95	160
CM252016-R47ML	0.47	±20 %	25	25.2	160	1.00	155
CM252016-R56ML	0.56	±20 %	25	25.2	150	1.10	150
CM252016-R68ML	0.68	±20 %	25	25.2	135	1.25	140
CM252016-R82ML	0.82	±20 %	25	25.2	125	1.40	130
CM252016-1R0KL	1.0	±10 %	25	7.96	115	0.65	195
CM252016-1R2KL	1.2	±10 %	25	7.96	100	0.75	180
CM252016-1R5KL	1.5	±10 %	25	7.96	90	0.85	170
CM252016-1R8KL	1.8	±10 %	25	7.96	85	0.95	160
CM252016-2R2KL	2.2	±10 %	25	7.96	80	1.05	155
CM252016-2R7KL	2.7	±10 %	25	7.96	75	1.2	145
CM252016-3R3KL	3.3	±10 %	25	7.96	65	1.3	135
CM252016-3R9KL	3.9	±10 %	25	7.96	60	1.4	130
CM252016-4R7KL	4.7	±10 %	25	7.96	55	1.6	125
CM252016-5R6KL	5.6	±10 %	25	7.96	50	1.8	120
CM252016-6R8KL	6.8	±10 %	25	7.96	45	1.9	115
CM252016-8R2KL	8.2	±10 %	25	7.96	40	2.2	105
CM252016-100KL	10	±10 %	25	2.52	32	3.5	80
CM252016-120KL	12	±10 %	25	2.52	30	3.8	75
CM252016-150KL	15	±10 %	25	2.52	28	4.4	70
CM252016-180KL	18	±10 %	25	2.52	25	5.0	65
CM252016-220KL	22	±10 %	25	2.52	22	5.8	60
CM252016-270KL	27	±10 %	20	2.52	21	6.3	115
CM252016-330KL	33	±10 %	20	2.52	20	7.1	110
CM252016-390KL	39	±10 %	20	2.52	18	9.5	90
CM252016-470KL	47	±10 %	20	2.52	17	11.0	80
CM252016-560KL	56	±10 %	20	2.52	16	12.1	75
CM252016-680KL	68	±10 %	20	2.52	15	16.6	70
CM252016-820KL	82	±10 %	20	2.52	13	19.0	65
CM252016-101KL	100	±10 %	15	0.796	12	21.0	60

Tighter tolerance available on request. Consult factory.

NOTE: 10 nH to 180 nH 'air core' / 220 nH to 220 uH 'ferrite core'

Specifications are subject to change without notice.

Customers should verify actual device performance in their specific applications.

Chip Inductors - CM201212 Series Wirewound

BOURNS®

RoHS Compliant 0805 Size Part Number	Inductance μ H	Tolerance	Q min.	Test Frequency MHz	SRF min. MHz	RDC ohm max	IDC mA max
CM201212-10NKL	0.010	$\pm 10\%$	10	100	3300	0.20	540
CM201212-12NKL	0.012	$\pm 10\%$	10	100	3300	0.23	535
CM201212-15NKL	0.015	$\pm 10\%$	12	100	3000	0.25	520
CM201212-18NKL	0.018	$\pm 10\%$	12	100	3000	0.27	480
CM201212-22NKL	0.022	$\pm 10\%$	15	100	2600	0.29	465
CM201212-27NKL	0.027	$\pm 10\%$	15	100	2500	0.32	455
CM201212-33NKL	0.033	$\pm 10\%$	15	100	2000	0.37	395
CM201212-39NKL	0.039	$\pm 10\%$	15	100	2000	0.38	390
CM201212-47NKL	0.047	$\pm 10\%$	15	100	1600	0.42	385
CM201212-56NKL	0.056	$\pm 10\%$	15	100	1500	0.45	360
CM201212-68NKL	0.068	$\pm 10\%$	15	100	1400	0.52	340
CM201212-82NKL	0.082	$\pm 10\%$	15	100	1100	0.60	330
CM201212-R10KL	0.10	$\pm 10\%$	8	25.2	800	0.78	285
CM201212-R12KL	0.12	$\pm 10\%$	8	25.2	600	0.99	275
CM201212-R15KL	0.15	$\pm 10\%$	10	25.2	600	1.47	230
CM201212-R18KL	0.18	$\pm 10\%$	10	25.2	600	1.61	195
CM201212-R22KL	0.22	$\pm 10\%$	10	25.2	500	1.84	170
CM201212-R27KL	0.27	$\pm 10\%$	10	25.2	300	1.95	165
CM201212-R33KL	0.33	$\pm 10\%$	10	25.2	200	2.16	160
CM201212-R39KL	0.39	$\pm 10\%$	10	25.2	150	2.35	150
CM201212-R47KL	0.47	$\pm 10\%$	10	25.2	150	2.57	145
CM201212-R56KL	0.56	$\pm 10\%$	10	25.2	100	2.65	140
CM201212-R68KL	0.68	$\pm 10\%$	10	25.2	100	2.99	130
CM201212-R82KL	0.82	$\pm 10\%$	10	25.2	80	3.35	125
CM201212-1R0KL	1.0	$\pm 10\%$	8	7.96	80	3.82	120

Tighter tolerance available on request. Consult factory.

Chip Inductors - CM160808 Series Laser-cut Winding

BOURNS®

RoHS Compliant 0603 Size Part Number	Inductance nH	Tolerance	Q min.	Test Frequency MHz	SRF min. MHz	RDC ohm max	IDC mA max
CM160808-1N5DL	1.5	± 0.3 nH	8	100	6000	0.07	500
CM160808-1N8DL	1.8	± 0.3 nH	8	100	6000	0.08	500
CM160808-2N2DL	2.2	± 0.3 nH	8	100	6000	0.09	500
CM160808-2N7DL	2.7	± 0.3 nH	8	100	6000	0.10	500
CM160808-3N3DL	3.3	± 0.3 nH	9	100	5500	0.12	500
CM160808-3N9JL	3.9	±5 %	9	100	5500	0.15	450
CM160808-4N7JL	4.7	±5 %	9	100	4800	0.17	450
CM160808-5N6JL	5.6	±5 %	9	100	4600	0.18	430
CM160808-6N8JL	6.8	±5 %	9	100	3550	0.20	430
CM160808-8N2JL	8.2	±5 %	9	100	3500	0.28	400
CM160808-10N1JL	10	±5 %	10	100	2800	0.32	400
CM160808-12N1JL	12	±5 %	10	100	2800	0.35	400
CM160808-15N1JL	15	±5 %	10	100	2500	0.41	350
CM160808-18N1JL	18	±5 %	10	100	2300	0.45	350
CM160808-22N1JL	22	±5 %	10	100	2000	0.50	300
CM160808-27N1JL	27	±5 %	10	100	2000	0.55	300
CM160808-33N1JL	33	±5 %	10	100	1800	0.60	300
CM160808-39N1JL	39	±5 %	11	100	1800	0.80	300
CM160808-47N1JL	47	±5 %	11	100	1800	0.95	250
CM160808-56N1JL	56	±5 %	12	100	1800	1.2	250
CM160808-68N1JL	68	±5 %	12	100	1500	1.3	250
CM160808-82N1JL	82	±5 %	12	100	1500	1.5	250
CM160808-R10JL	100	±5 %	12	100	1300	1.8	200
CM160808-R12JL	120	±5 %	5	25.2	1200	3.0	130
CM160808-R15JL	150	±5 %	5	25.2	1100	4.5	100
CM160808-R18JL	180	±5 %	4	25.2	1000	6.5	80
CM160808-R22JL	220	±5 %	4	25.2	900	7.5	70

Specifications are subject to change without notice.
Customers should verify actual device performance in their specific applications.

Chip Inductors - CM100505 Series Laser-cut Winding

BOURNS®

RoHS Compliant 0402 Size Part Number	Inductance nH	Tolerance	Q min.	Test Frequency MHz	SRF min. MHz	RDC ohm max	IDC mA max
CM100505-1N0DL	1.00	±0.3 nH	8	100	6000	0.05	400
CM100505-1N2DL	1.20	±0.3 nH	8	100	6000	0.06	400
CM100505-1N5DL	1.50	±0.3 nH	8	100	6000	0.07	400
CM100505-1N8DL	1.80	±0.3 nH	8	100	6000	0.08	400
CM100505-2N2DL	2.20	±0.3 nH	8	100	6000	0.09	400
CM100505-2N7DL	2.70	±0.3 nH	8	100	5500	0.10	400
CM100505-3N3DL	3.30	±0.3 nH	8	100	5500	0.12	400
CM100505-3N9DL	3.90	±0.3 nH	8	100	5200	0.15	360
CM100505-4N7DL	4.70	±0.3 nH	8	100	4800	0.17	360
CM100505-5N6DL	5.60	±0.3 nH	8	100	4600	0.19	340
CM100505-6N8JL	6.80	± 5 %	8	100	4000	0.30	320
CM100505-8N2JL	8.20	± 5 %	8	100	3500	0.35	320
CM100505-10NJL	10.00	± 5 %	8	100	2800	0.41	320
CM100505-12NJL	12.00	± 5 %	8	100	2800	0.45	320
CM100505-15NJL	15.00	± 5 %	8	100	2500	0.60	240
CM100505-18NJL	18.00	± 5 %	8	100	2200	0.70	240
CM100505-22NJL	22.00	± 5 %	8	100	2000	0.80	200
CM100505-27NJL	27.00	± 5 %	8	100	1800	1.2	200
CM100505-33NJL	33.00	± 5 %	8	100	1800	1.4	170
CM100505-39NJL	39.00	± 5 %	8	100	1800	1.7	150
CM100505-47NJL	47.00	± 5 %	8	100	1800	2.1	140
CM100505-56NJL	56.00	± 5 %	8	100	1500	2.5	130
CM100505-68NJL	68.00	± 5 %	8	100	1500	4.0	120
CM100505-82NJL	82.00	± 5 %	8	100	1400	4.5	110
CM100505-R10JL	100.00	± 5 %	8	100	1200	5.5	90