

3-TERMINAL POSITIVE VOLTAGE REGULATOR

■ GENERAL DESCRIPTION

The NJM7800 series of monolithic 3-Terminal Positive Voltage Regulators is constructed using the New JRC Planar epitaxial process. These regulators employ internal current-limiting, thermal-shutdown and safe-area compensation making them essentially indestructible. If adequate heat sinking is provided, they can deliver over 1A output current. They are intended as fixed voltage regulators in a wide range of applications including local (on card) regulation for elimination of distribution problems associated with single point regulation. In addition to use as fixed voltage regulators, these devices can be used with external components to obtain adjustable output voltages and currents.

■ FEATURES

- Operating Voltage
- Internal Short Circuit Current Limit
- Internal Thermal Overload Protection
- Excellent Ripple Rejection
- Guarantee'd 1.5A Output Current
- Package Outline TO-220F, TO-252
- Bipolar Technology

■ EQUIVALENT CIRCUIT

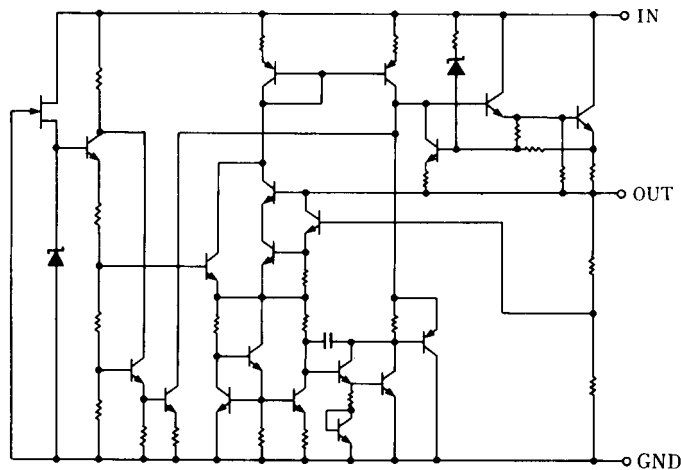

■ PACKAGE OUTLINE

(TO-220F)

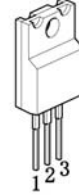

(TO-252)

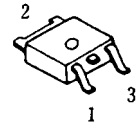

NJM7800FA

1. IN
2. GND
3. OUT

NJM7800DL1A

1. IN
2. GND
3. OUT

(note) The radiation fin is connected pin2.

NJM7800

■ ABSOLUTE MAXIMUM RATINGS

(Ta=25°C)

| PARAMETER | SYMBOL | MAXIMUM RATINGS | | UNIT |
|-----------------------------|--------------------------------|--|---|------|
| Input Voltage | V_{IN} | 7805 to 7809 7812 to 7815 7818 to 7824 | 35 35 40 | V |
| Storage Temperature Range | T_{stg} | -40 to +150 | | °C |
| Operating Temperature Range | Operating Junction Temperature | T_j | -40 to +150 | °C |
| | | T_{opr} | -40 to +85 | |
| Power Dissipation | P_D | TO-220F TO-252 | 16($T_C \leq 70^\circ\text{C}$) 10($T_C = 25^\circ\text{C}$) 1($T_a \leq 25^\circ\text{C}$) | W |

■ THERMAL CHARACTERISTICS

| | | | TO220F | TO252 | | |
|--------------------|---------------------------------|---------------|--------|-------|------|--|
| Thermal Resistance | Junction-to-Ambient Temperature | θ_{ja} | 60 | 125 | °C/W | |
| | Junction-to-Case | θ_{jc} | 5 | 12.5 | | |

■ ELECTRICAL CHARACTERISTICS (C₁=0.33μF, C_O=0.1μF, T_J=25°C)

Measurement is to be conducted in pulse testing.

| PARAMETER | SYMBOL | TEST CONDITIONS | FTYP. | | | DL TYP. | | | UNIT |
|---|-----------------------|---|-------|------|------|---------|------|------|-------|
| | | | MIN. | TYP. | MAX. | MIN. | TYP. | MAX. | |
| NJM7805FA/DL1A | | | | | | | | | |
| Output Voltage | V_O | $V_{IN}=10\text{V}, I_O=0.5\text{A}$ | 4.8 | 5.0 | 5.2 | 4.8 | 5.0 | 5.2 | V |
| Quiescent Current | I_Q | $V_{IN}=10\text{V}, I_O=0\text{mA}$ | - | 4.2 | 6.0 | - | 4.2 | 6.0 | mA |
| Load Regulation | $\Delta V_O - I_O$ | $V_{IN}=10\text{V}, I_O=0.005$ to 1.5A | - | 15 | 50 | - | 15 | 100 | mV |
| Line Regulation | $\Delta V_O - V_{IN}$ | $V_{IN}=7$ to 25V, $I_O=0.5\text{A}$ | - | 3 | 50 | - | 3 | 100 | mV |
| Ripple Rejection | RR | $V_{IN}=10\text{V}, I_O=0.5\text{A}, e_{in}=2V_{P-P}, f=120\text{Hz}$ | 68 | 78 | - | 68 | 78 | - | dB |
| Output Noise Voltage | V_{NO} | $V_{IN}=10\text{V}, \text{BW}=10\text{Hz to } 100\text{kHz}, I_O=0.5\text{A}$ | - | 45 | - | - | 45 | - | μV |
| Average Temperature Coefficient of Output Voltage | $\Delta V_O/\Delta T$ | $V_{IN}=10\text{V}, I_O=5\text{mA}$ | - | -0.5 | - | - | -0.5 | - | mV/°C |

■ **ELECTRICAL CHARACTERISTICS** ($C_1=0.33\mu\text{F}$, $C_O=0.1\mu\text{F}$, $T_f=25^\circ\text{C}$)

Measurement is to be conducted in pulse testing.

| PARAMETER | SYMBOL | TEST CONDITIONS | FTYP. | | | DL TYP. | | | UNIT |
|---|-----------------------|--|-------|------|------|---------|------|------|----------------------------|
| | | | MIN. | TYP. | MAX. | MIN. | TYP. | MAX. | |
| NJM7806FA/DL1 | | | | | | | | | |
| Output Voltage | V_O | $V_{IN}=11\text{V}$, $I_O=0.5\text{A}$ | 5.75 | 6.0 | 6.25 | 5.75 | 6.0 | 6.25 | V |
| Quiescent Current | I_Q | $V_{IN}=11\text{V}$, $I_O=0\text{mA}$ | - | 4.3 | 6.0 | - | 4.3 | 6.0 | mA |
| Load Regulation | $\Delta V_O - I_O$ | $V_{IN}=11\text{V}$, $I_O=0.005$ to 1.5A | - | 15 | 60 | - | 15 | 120 | mV |
| Line Regulation | $\Delta V_O - V_{IN}$ | $V_{IN}=8$ to 25V , $I_O=0.5\text{A}$ | - | 5 | 60 | - | 5 | 120 | mV |
| Ripple Rejection | RR | $V_{IN}=11\text{V}$, $I_O=0.5\text{A}$, $e_{in}=2V_{P-P}$, $f=120\text{Hz}$ | 65 | 75 | - | 65 | 75 | - | dB |
| Output Noise Voltage | V_{NO} | $V_{IN}=11\text{V}$, $BW=10\text{Hz}$ to 100kHz , $I_O=0.5\text{A}$ | - | 45 | - | - | 45 | - | μV |
| Average Temperature Coefficient of Output Voltage | $\Delta V_O/\Delta T$ | $V_{IN}=11\text{V}$, $I_O=5\text{mA}$ | - | -0.6 | - | - | -0.6 | - | $\text{mV}/^\circ\text{C}$ |
| NJM7808FA/DL1 | | | | | | | | | |
| Output Voltage | V_O | $V_{IN}=14\text{V}$, $I_O=0.5\text{A}$ | 7.7 | 8.0 | 8.3 | 7.7 | 8.0 | 8.3 | V |
| Quiescent Current | I_Q | $V_{IN}=14\text{V}$, $I_O=0\text{mA}$ | - | 4.3 | 6.0 | - | 4.3 | 6.0 | mA |
| Load Regulation | $\Delta V_O - I_O$ | $V_{IN}=14\text{V}$, $I_O=0.005$ to 1.5A | - | 15 | 80 | - | 15 | 160 | mV |
| Line Regulation | $\Delta V_O - V_{IN}$ | $V_{IN}=10.5$ to 25V , $I_O=0.5\text{A}$ | - | 6 | 80 | - | 6 | 160 | mV |
| Ripple Rejection | RR | $V_{IN}=14\text{V}$, $I_O=0.5\text{A}$, $e_{in}=2V_{P-P}$, $f=120\text{Hz}$ | 62 | 72 | - | 62 | 72 | - | dB |
| Output Noise Voltage | V_{NO} | $V_{IN}=14\text{V}$, $BW=10\text{Hz}$ to 100kHz , $I_O=0.5\text{A}$ | - | 55 | - | - | 55 | - | μV |
| Average Temperature Coefficient of Output Voltage | $\Delta V_O/\Delta T$ | $V_{IN}=14\text{V}$, $I_O=5\text{mA}$ | - | -0.8 | - | - | -0.8 | - | $\text{mV}/^\circ\text{C}$ |
| NJM7809FA/DL1 | | | | | | | | | |
| Output Voltage | V_O | $V_{IN}=15\text{V}$, $I_O=0.5\text{A}$ | 8.65 | 9.0 | 9.35 | 8.65 | 9.0 | 9.35 | V |
| Quiescent Current | I_Q | $V_{IN}=15\text{V}$, $I_O=0\text{mA}$ | - | 4.3 | 6.0 | - | 4.3 | 6.0 | mA |
| Load Regulation | $\Delta V_O - I_O$ | $V_{IN}=15\text{V}$, $I_O=0.005$ to 1.5A | - | 15 | 90 | - | 15 | 180 | mV |
| Line Regulation | $\Delta V_O - V_{IN}$ | $V_{IN}=11.5$ to 25V , $I_O=0.5\text{A}$ | - | 7 | 90 | - | 7 | 180 | mV |
| Ripple Rejection | RR | $V_{IN}=15\text{V}$, $I_O=0.5\text{A}$, $e_{in}=2V_{P-P}$, $f=120\text{Hz}$ | 62 | 72 | - | 62 | 72 | - | dB |
| Output Noise Voltage | V_{NO} | $V_{IN}=15\text{V}$, $BW=10\text{Hz}$ to 100kHz , $I_O=0.5\text{A}$ | - | 60 | - | - | 60 | - | μV |
| Average Temperature Coefficient of Output Voltage | $\Delta V_O/\Delta T$ | $V_{IN}=15\text{V}$, $I_O=5\text{mA}$ | - | -0.9 | - | - | -0.9 | - | $\text{mV}/^\circ\text{C}$ |
| NJM7812FA/DL1 | | | | | | | | | |
| Output Voltage | V_O | $V_{IN}=19\text{V}$, $I_O=0.5\text{A}$ | 11.5 | 12.0 | 12.5 | 11.5 | 12.0 | 12.5 | V |
| Quiescent Current | I_Q | $V_{IN}=19\text{V}$, $I_O=0\text{mA}$ | - | 4.3 | 6.0 | - | 4.3 | 6.0 | mA |
| Load Regulation | $\Delta V_O - I_O$ | $V_{IN}=19\text{V}$, $I_O=0.005$ to 1.5A | - | 25 | 120 | - | 25 | 240 | mV |
| Line Regulation | $\Delta V_O - V_{IN}$ | $V_{IN}=14.5$ to 30V , $I_O=0.5\text{A}$ | - | 10 | 120 | - | 10 | 240 | mV |
| Ripple Rejection | RR | $V_{IN}=19\text{V}$, $I_O=0.5\text{A}$, $e_{in}=2V_{P-P}$, $f=120\text{Hz}$ | 61 | 71 | - | 61 | 71 | - | dB |
| Output Noise Voltage | V_{NO} | $V_{IN}=19\text{V}$, $BW=10\text{Hz}$ to 100kHz , $I_O=0.5\text{A}$ | - | 75 | - | - | 75 | - | μV |
| Average Temperature Coefficient of Output Voltage | $\Delta V_O/\Delta T$ | $V_{IN}=19\text{V}$, $I_O=5\text{mA}$ | - | -1.2 | - | - | -1.2 | - | $\text{mV}/^\circ\text{C}$ |

NJM7800

■ ELECTRICAL CHARACTERISTICS (C₁=0.33μF, C_O=0.1μF, T_J=25°C)

Measurement is to be conducted in pulse testing.

| PARAMETER | SYMBOL | TEST CONDITIONS | FTYP. | | | DL TYP. | | | UNIT |
|---|-----------------------------------|--|-------|------|------|---------|------|------|-------|
| | | | MIN. | TYP. | MAX. | MIN. | TYP. | MAX. | |
| NJM7815FA/DL1 | | | | | | | | | |
| Output Voltage | V _O | V _{IN} =23V, I _O =0.5A | 14.4 | 15.0 | 15.6 | 14.4 | 15.0 | 15.6 | V |
| Quiescent Current | I _Q | V _{IN} =23V, I _O =0mA | - | 4.4 | 6.0 | - | 4.4 | 6.0 | mA |
| Load Regulation | ΔV _O - I _O | V _{IN} =23V, I _O =0.005 to 1.5A | - | 35 | 150 | - | 35 | 300 | mV |
| Line Regulation | ΔV _O - V _{IN} | V _{IN} =17.5 to 30V, I _O =0.5A | - | 11 | 150 | - | 11 | 300 | mV |
| Ripple Rejection | RR | V _{IN} =23V, I _O =0.5A, e _{in} =2V _{P-P} , f=120Hz | 60 | 70 | - | 60 | 70 | - | dB |
| Output Noise Voltage | V _{NO} | V _{IN} =23V, BW=10Hz to 100kHz, I _O =0.5A | - | 90 | - | - | 90 | - | μV |
| Average Temperature Coefficient of Output Voltage | ΔV _O /ΔT | V _{IN} =23V, I _O =5mA | - | -1.5 | - | - | -1.5 | - | mV/°C |
| NJM7818FA/DL1 | | | | | | | | | |
| Output Voltage | V _O | V _{IN} =27V, I _O =0.5A | 17.3 | 18.0 | 18.7 | 17.3 | 18.0 | 18.7 | V |
| Quiescent Current | I _Q | V _{IN} =27V, I _O =0mA | - | 4.5 | 6.0 | - | 4.5 | 6.0 | mA |
| Load Regulation | ΔV _O - I _O | V _{IN} =27V, I _O =0.005 to 1.5A | - | 55 | 180 | - | 55 | 360 | mV |
| Line Regulation | ΔV _O - V _{IN} | V _{IN} =21 to 33V, I _O =0.5A | - | 15 | 180 | - | 15 | 360 | mV |
| Ripple Rejection | RR | V _{IN} =27V, I _O =0.5A, e _{in} =2V _{P-P} , f=120Hz | 59 | 69 | - | 59 | 69 | - | dB |
| Output Noise Voltage | V _{NO} | V _{IN} =27V, BW=10Hz to 100kHz, I _O =0.5A | - | 100 | - | - | 100 | - | μV |
| Average Temperature Coefficient of Output Voltage | ΔV _O /ΔT | V _{IN} =27V, I _O =5mA | - | -1.8 | - | - | -1.8 | - | mV/°C |
| NJM7820FA/DL1 | | | | | | | | | |
| Output Voltage | V _O | V _{IN} =29V, I _O =0.5A | 19.2 | 20.0 | 20.8 | 19.2 | 20.0 | 20.8 | V |
| Quiescent Current | I _Q | V _{IN} =29V, I _O =0mA | - | 4.5 | 6.0 | - | 4.5 | 6.0 | mA |
| Load Regulation | ΔV _O - I _O | V _{IN} =29V, I _O =0.005 to 1.5A | - | 61 | 200 | - | 61 | 400 | mV |
| Line Regulation | ΔV _O - V _{IN} | V _{IN} =23 to 35V, I _O =0.5A | - | 16 | 200 | - | 16 | 400 | mV |
| Ripple Rejection | RR | V _{IN} =29V, I _O =0.5A, e _{in} =2V _{P-P} , f=120Hz | 58 | 68 | - | 58 | 68 | - | dB |
| Output Noise Voltage | V _{NO} | V _{IN} =29V, BW=10Hz to 100kHz, I _O =0.5A | - | 120 | - | - | 120 | - | μV |
| Average Temperature Coefficient of Output Voltage | ΔV _O /ΔT | V _{IN} =29V, I _O =5mA | - | -2.0 | - | - | -2.0 | - | mV/°C |
| NJM7824FA/DL1 | | | | | | | | | |
| Output Voltage | V _O | V _{IN} =33V, I _O =0.5A | 23.0 | 24.0 | 25.0 | 23.0 | 24.0 | 25.0 | V |
| Quiescent Current | I _Q | V _{IN} =33V, I _O =0mA | - | 4.6 | 6.0 | - | 4.6 | 6.0 | mA |
| Load Regulation | ΔV _O - I _O | V _{IN} =33V, I _O =0.005 to 1.5A | - | 65 | 240 | - | 65 | 480 | mV |
| Line Regulation | ΔV _O - V _{IN} | V _{IN} =27 to 38V, I _O =0.5A | - | 18 | 240 | - | 18 | 480 | mV |
| Ripple Rejection | RR | V _{IN} =33V, I _O =0.5A, e _{in} =2V _{P-P} , f=120Hz | 56 | 66 | - | 56 | 66 | - | dB |
| Output Noise Voltage | V _{NO} | V _{IN} =33V, BW=10Hz to 100kHz, I _O =0.5A | - | 120 | - | - | 120 | - | μV |
| Average Temperature Coefficient of Output Voltage | ΔV _O /ΔT | V _{IN} =33V, I _O =5mA | - | -2.4 | - | - | -2.4 | - | mV/°C |

POWER DISSIPATION VS. AMBIENT TEMPERATURE

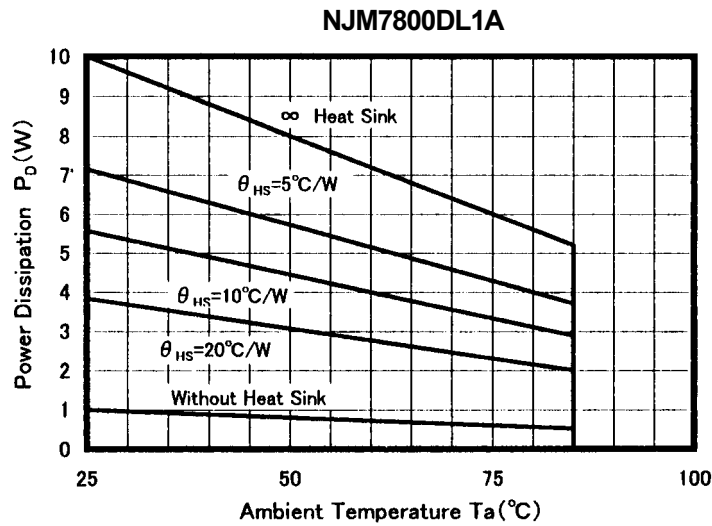
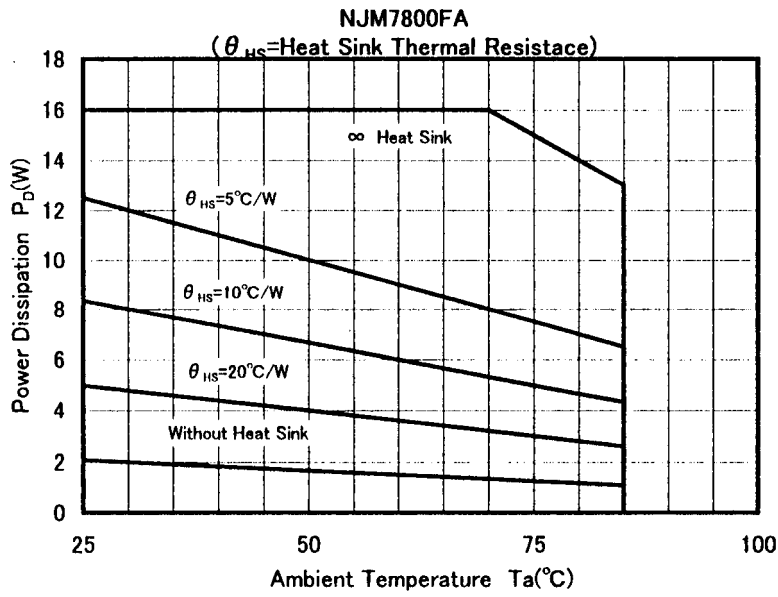

TEST CIRCUIT

1. Output Voltage, Line Regulation, Load Regulation, Quiescent Current, Average Temperature Coefficient of Output Voltage, Output Noise Voltage
2. Ripple Rejection

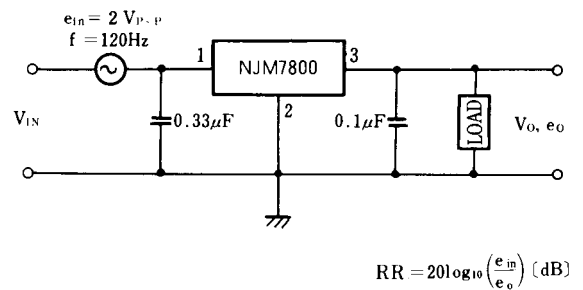
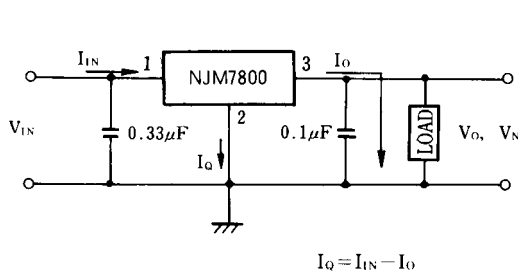

NJM7800

■ TYPICAL CHARACTERISTICS

NJM7805/15/24 Output Characteristics
($I_o=0.5A$, $T_j=25^\circ C$)

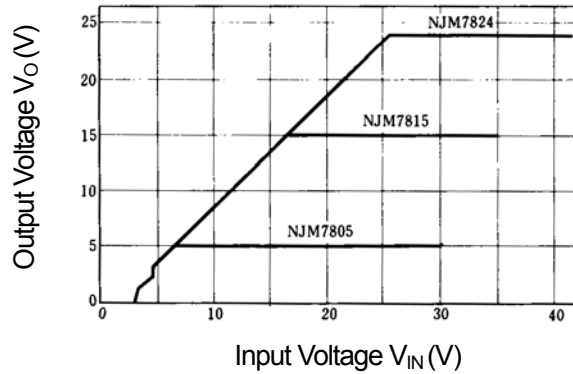

NJM7805 Dropout Characteristics
($T_j=25^\circ C$)

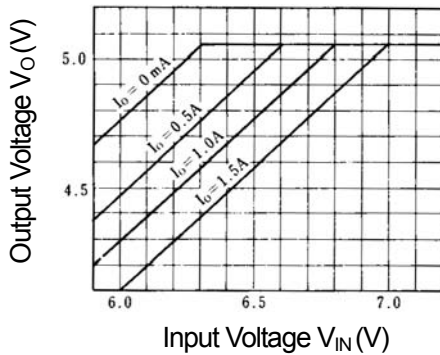

NJM7812 Dropout Characteristics
($T_j=25^\circ C$)

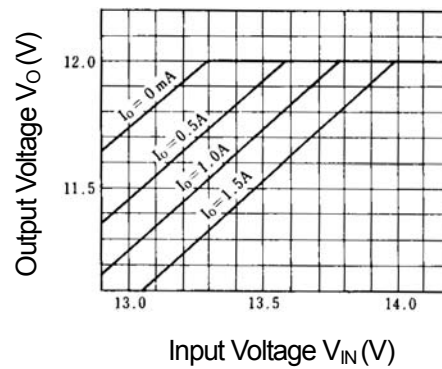

NJM7805/15/24 Load Characteristics
($T_j=25^\circ C$)

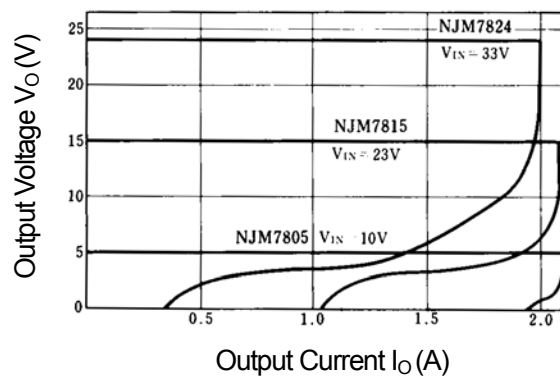

■ TYPICAL CHARACTERISTICS

NJM7800 Series Short Circuit Output Current

($T_j=25^\circ\text{C}$, ∞ Heat Sink)

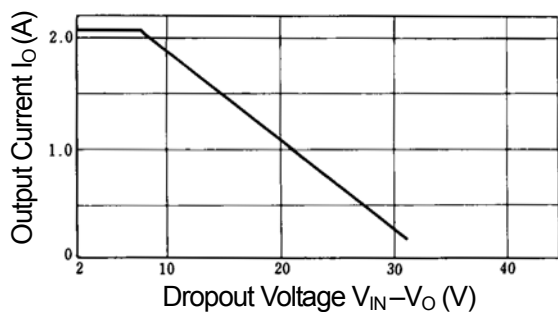

NJM7805/24 Quiescent Current vs. Input Voltage

($T_j=25^\circ\text{C}$.)

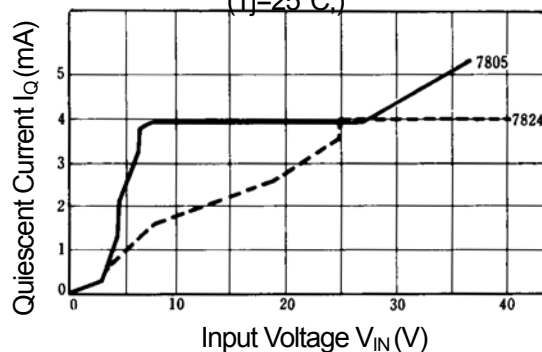

NJM7805/15/24 Output Voltage vs. Junction Temperature

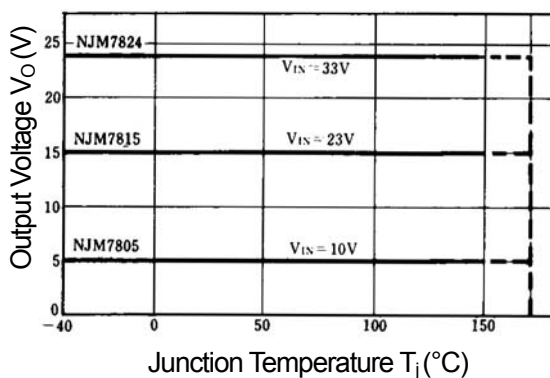

NJM7805/15/24 Ripple Rejection vs. Frequency

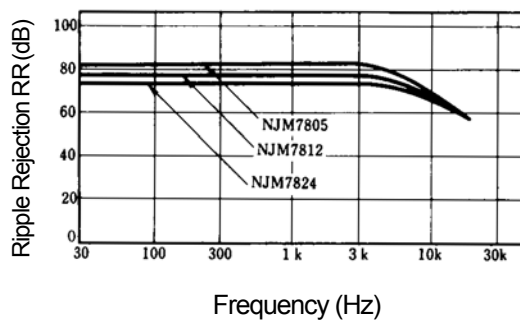

$V_{IN} = 10\text{V (05)}$ $e_{in} = 2V_{P-P}$
 19V (12)
 33V (24)
 $T_j = 25^\circ\text{C}$

■ TYPICAL CHARACTERISTICS

NJM7805 Output Voltage vs. Temperature

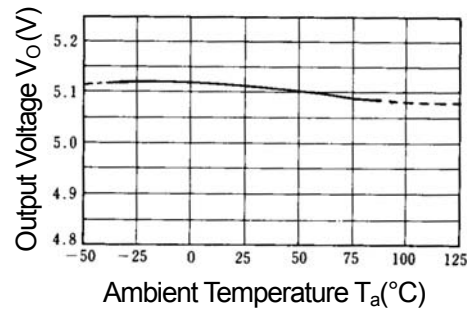

NJM7808 Output Voltage vs. Temperature

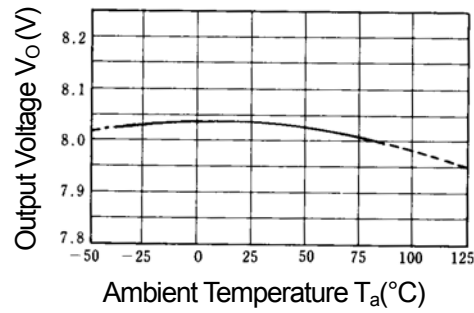

[CAUTION]

The specifications on this databook are only given for information, without any guarantee as regards either mistakes or omissions. The application circuits in this databook are described only to show representative usages of the product and not intended for the guarantee or permission of any right including the industrial rights.

Mouser Electronics

Authorized Distributor

Click to View Pricing, Inventory, Delivery & Lifecycle Information:

[NJR:](#)

[NJM7818FA](#) [NJM7808FA](#) [NJM7805FA](#) [NJM7809FA](#) [NJM7815FA](#) [NJM7824FA](#) [NJM7820FA](#) [NJM7812FA](#)