

Silicon NPN Power Transistors

2SC3466

DESCRIPTION

- With TO-3PN package
- High breakdown voltage and high reliability.
- Fast switching speed
- Wide area of safe operation

APPLICATIONS

- Switching regulator applications

PINNING

PIN	DESCRIPTION
1	Base
2	Collector;connected to mounting base
3	Emitter

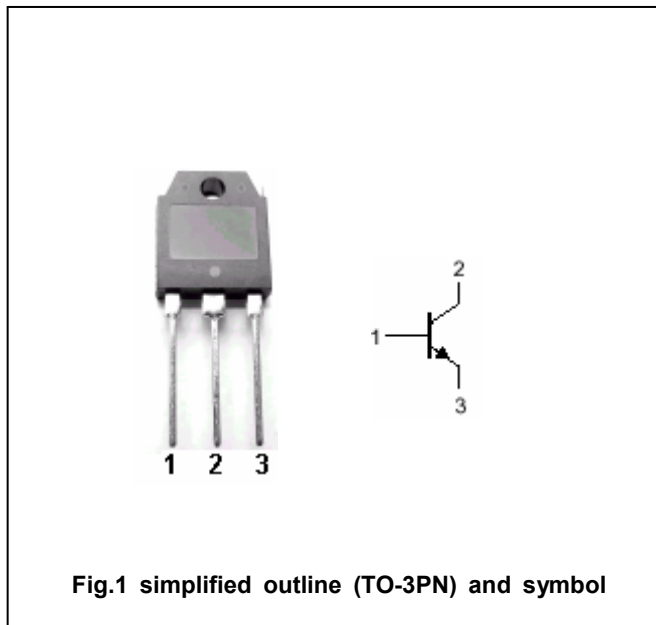

Fig.1 simplified outline (TO-3PN) and symbol

Absolute maximum ratings(Ta=□)

SYMBOL	PARAMETER	CONDITIONS	VALUE	UNIT
V <sub>CBO</sub>	Collector-base voltage	Open emitter	1200	V
V <sub>CEO</sub>	Collector-emitter voltage	Open base	650	V
V <sub>EBO</sub>	Emitter-base voltage	Open collector	7	V
I <sub>C</sub>	Collector current		8	A
I <sub>CM</sub>	Collector current-peak		20	A
I <sub>B</sub>	Base current		3	A
P <sub>C</sub>	Collector power dissipation	T <sub>C</sub> =25□	120	W
T <sub>j</sub>	Junction temperature		150	□
T <sub>stg</sub>	Storage temperature		-55~150	□

## Silicon NPN Power Transistors

## 2SC3466

## CHARACTERISTICS

T<sub>j</sub>=25 °C unless otherwise specified

SYMBOL	PARAMETER	CONDITIONS	MIN	TYP.	MAX	UNIT
V <sub>(BR)CEO</sub>	Collector-emitter breakdown voltage	I <sub>C</sub> =5mA ; R <sub>BE</sub> =∞	650			V
V <sub>(BR)CBO</sub>	Collector-base breakdown voltage	I <sub>C</sub> =1mA ; I <sub>E</sub> =0	1200			V
V <sub>(BR)EBO</sub>	Emitter-base breakdown voltage	I <sub>E</sub> =1mA ; I <sub>C</sub> =0	7			V
V <sub>CEsat</sub>	Collector-emitter saturation voltage	I <sub>C</sub> =4A ; I <sub>B</sub> =0.8A			3.0	V
V <sub>BEsat</sub>	Base-emitter saturation voltage	I <sub>C</sub> =4A ; I <sub>B</sub> =0.8A			1.5	V
I <sub>CBO</sub>	Collector cut-off current	V <sub>CB</sub> =650V ; I <sub>E</sub> =0			100	μA
I <sub>EBO</sub>	Emitter cut-off current	V <sub>EB</sub> =5V ; I <sub>C</sub> =0			100	μA
h <sub>FE-1</sub>	DC current gain	I <sub>C</sub> =1A ; V <sub>CE</sub> =5V	10		40	
h <sub>FE-2</sub>	DC current gain	I <sub>C</sub> =4A ; V <sub>CE</sub> =5V	6			
C <sub>ob</sub>	Output capacitance	I <sub>E</sub> =0 ; V <sub>CB</sub> =10V ; f=1MHz		120		pF
f <sub>T</sub>	Transition frequency	I <sub>C</sub> =1A ; V <sub>CE</sub> =10V		5		MHz

## Switching times

t <sub>on</sub>	Turn-on time	I <sub>C</sub> =4A ; R <sub>L</sub> =50Ω I <sub>B1</sub> =0.8A ; I <sub>B2</sub> =-1.6A V <sub>CC</sub> =200V			1.0	μs
t <sub>stg</sub>	Storage time				4.0	μs
t <sub>f</sub>	Fall time				0.7	μs

◆ h<sub>FE-1</sub> Classifications

K	L	M
10-20	15-30	20-40

Silicon NPN Power Transistors

2SC3466

PACKAGE OUTLINE

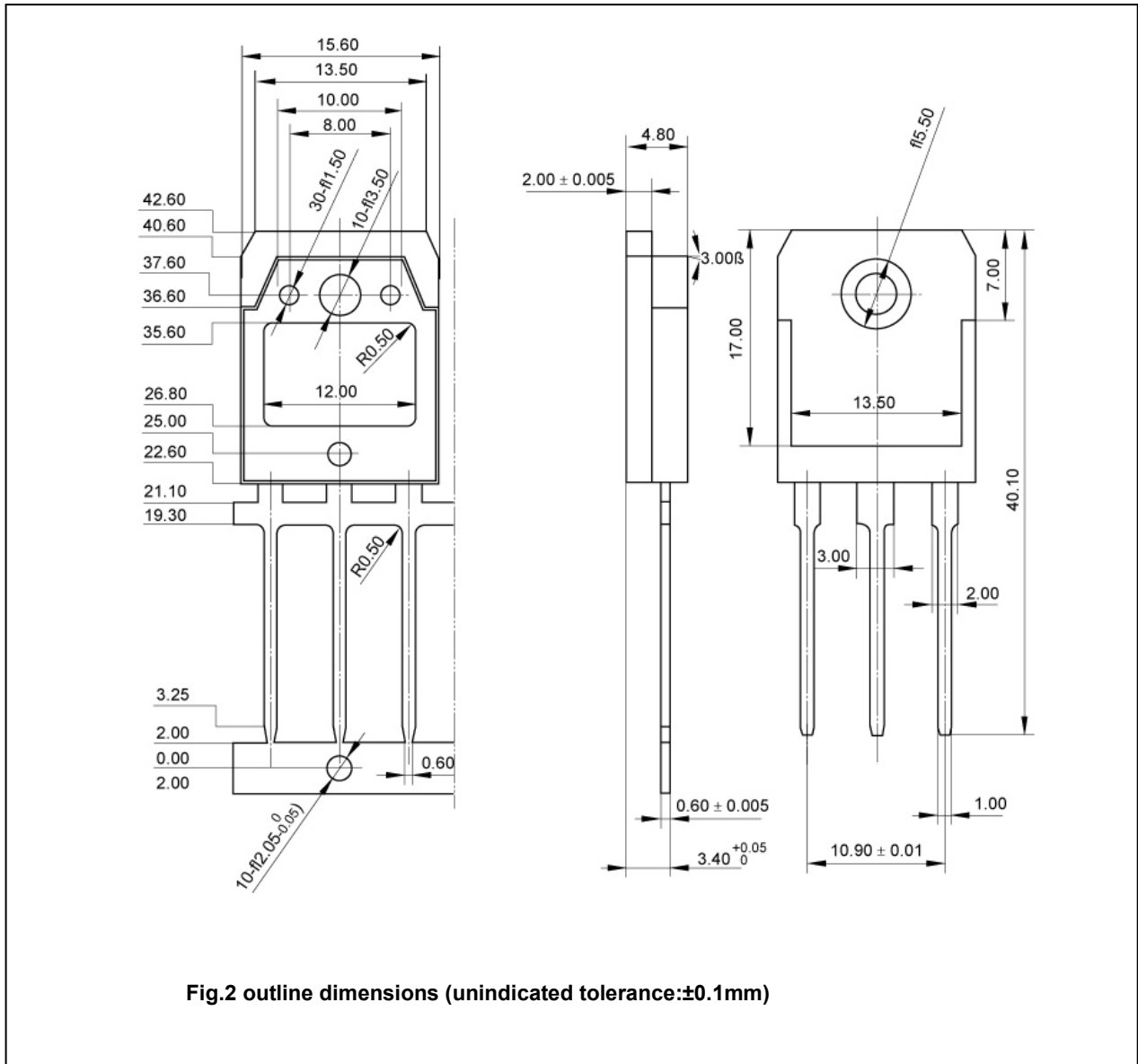

Silicon NPN Power Transistors

2SC3466

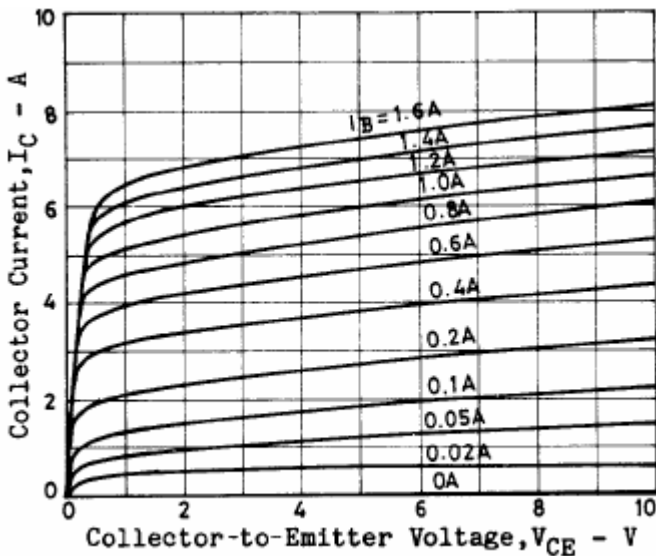

Fig.3 Static Characteristic

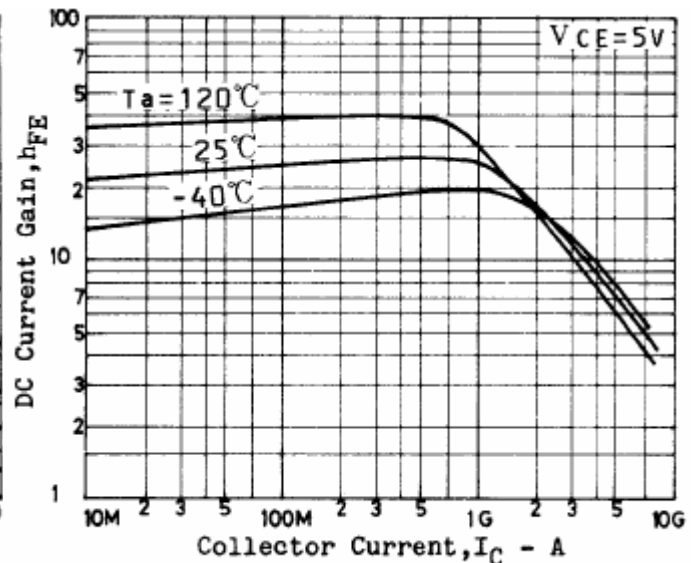

Fig.4 DC current Gain

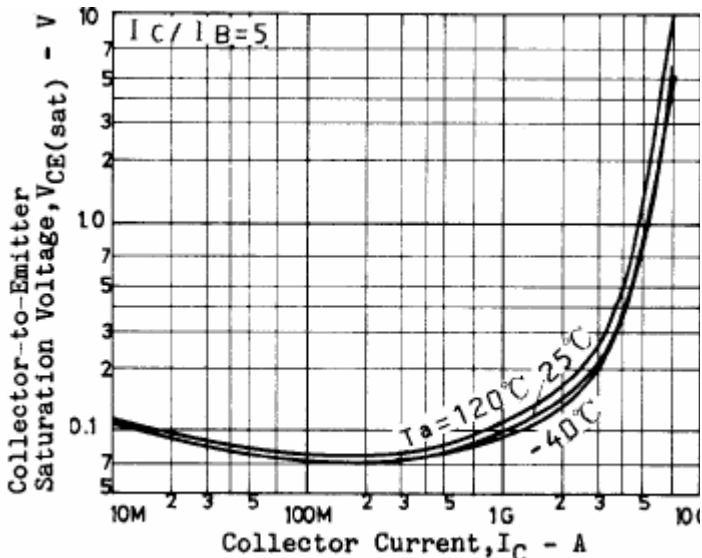

Fig.5 Collector-Emmitter Saturation Voltage

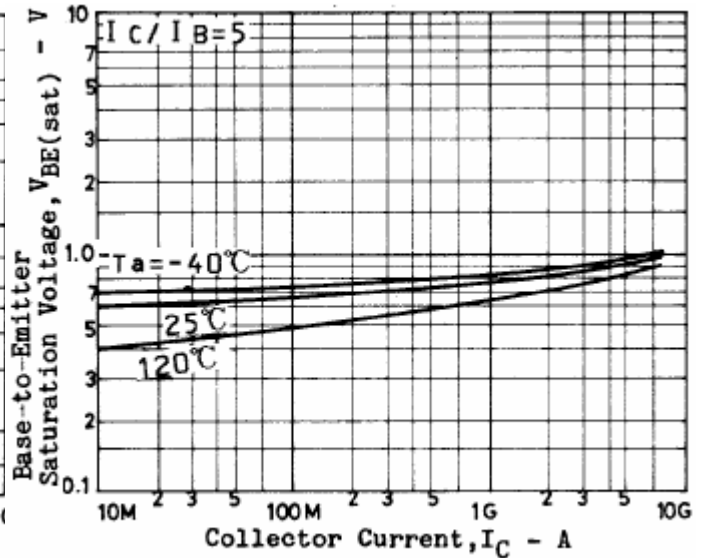

Fig.6 Base-Emmitter Saturation Voltage

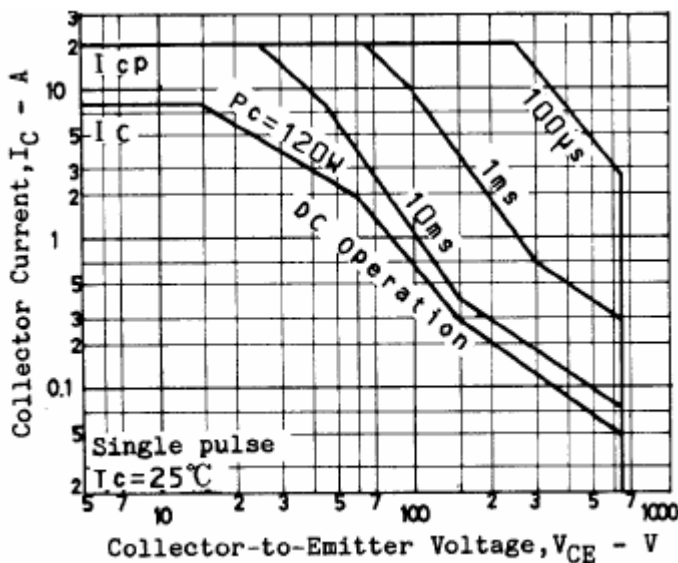

Fig.7 Safe Operating Area