

Schottky Diode Gen²

High Performance Schottky Diode
Low Loss and Soft Recovery
Single Diode

Part number

DSA 30 I 150 PA

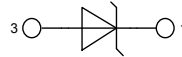

$$\begin{aligned} V_{RRM} &= 150 \text{ V} \\ I_{FAV} &= 30 \text{ A} \\ V_F &= 0.80 \text{ V} \end{aligned}$$

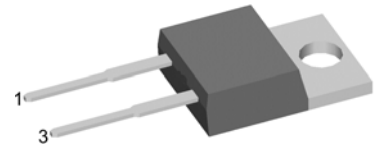

Backside: cathode

Features / Advantages:

- Very low V_f
- Extremely low switching losses
- low I_{rm} values
- Improved thermal behaviour
- High reliability circuit operation
- Low voltage peaks for reduced protection circuits
- Low noise switching

Applications:

- Rectifiers in switch mode power supplies (SMPS)
- Free wheeling diode in low voltage converters

Package:

- Housing: TO-220
- Industry standard outline
- Epoxy meets UL 94V-0
- RoHS compliant

Symbol	Definition	Conditions	Ratings			Unit
			min.	typ.	max.	
V_{RRM}	max. repetitive reverse voltage				150	V
I_R	reverse current	$V_R = 150 \text{ V}$			0.9	mA
		$V_R = 150 \text{ V}$			5	mA
V_F	forward voltage	$I_F = 30 \text{ A}$			0.93	V
		$I_F = 60 \text{ A}$			1.09	V
		$I_F = 30 \text{ A}$			0.80	V
		$I_F = 60 \text{ A}$			0.98	V
I_{FAV}	average forward current	rectangular d = 0.5			30	A
V_{F0}	threshold voltage				0.55	V
r_F	slope resistance				6	m Ω
R_{thJC}	thermal resistance junction to case				0.85	K/W
T_{VJ}	virtual junction temperature		-55		175	$^{\circ}\text{C}$
P_{tot}	total power dissipation				175	W
I_{FSM}	max. forward surge current	t = 10 ms (50 Hz), sine			200	A
C_J	junction capacitance	$V_R = 12 \text{ V}$; f = 1 MHz		289		pF

Symbol	Definition	Conditions	Ratings			Unit
			min.	typ.	max.	
I_{RMS}	RMS current	per pin ¹⁾			35	A
R_{thCH}	thermal resistance case to heatsink			0.50		K/W
T_{stg}	storage temperature		-55		150	°C
Weight				2		g
M_D	mounting torque		0.4		0.6	Nm
F_C	mounting force with clip		20		60	N

¹⁾ I_{RMS} is typically limited by: 1. pin-to-chip resistance; or by 2. current capability of the chip.
 In case of 1, a common cathode/anode configuration and a non-isolated backside, the whole current capability can be used by connecting the backside.

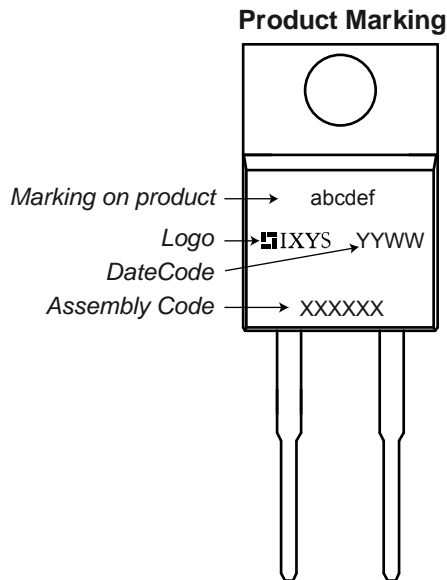
Part number

- D = Diode
- S = Schottky Diode
- A = low VF
- 30 = Current Rating [A]
- I = Single Diode
- 150 = Reverse Voltage [V]
- PA = TO-220AC (2)

Ordering	Part Name	Marking on Product	Delivering Mode	Base Qty	Code Key
Standard	DSA 30 I 150 PA	DSA30I150PA	Tube	50	504155

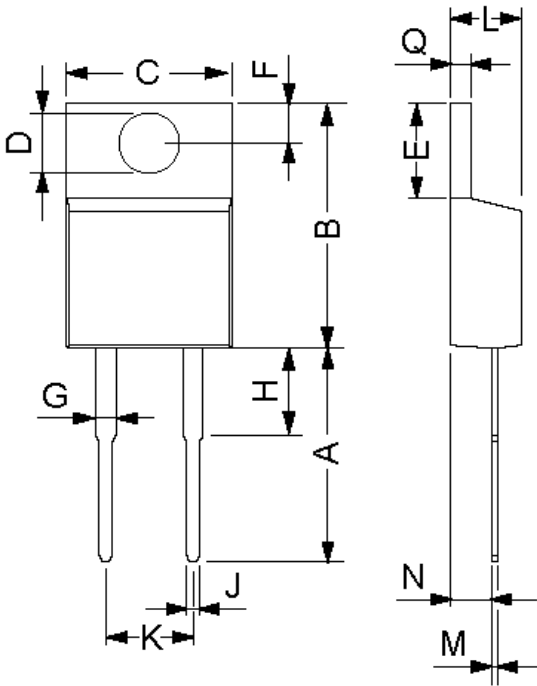
Outlines TO-220

Dim.	Millimeter		Inches	
	Min.	Max.	Min.	Max.
A	12.7	14.73	0.5	0.58
B	14.23	16.51	0.56	0.65
C	9.66	10.66	0.38	0.42
D	3.54	4.08	0.139	0.161
E	5.85	6.85	2.3	0.42
F	2.54	3.42	0.1	0.135
G	1.15	1.77	0.045	0.07
H	-	6.35	-	0.25
J	0.64	0.89	0.025	0.035
K	4.83	5.33	0.19	0.21
L	3.56	4.82	0.14	0.19
M	0.51	0.76	0.02	0.03
N	2.04	2.49	0.08	0.115
Q	0.64	1.39	0.025	0.055

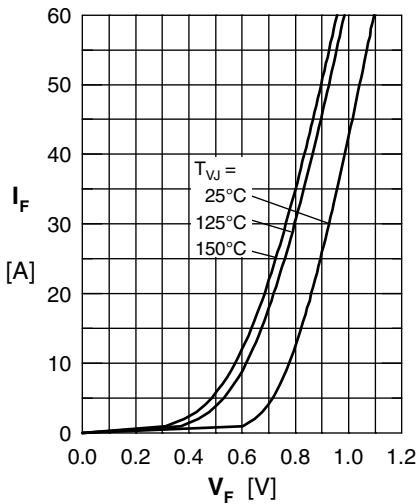

Fig. 1 Maximum forward voltage drop characteristics

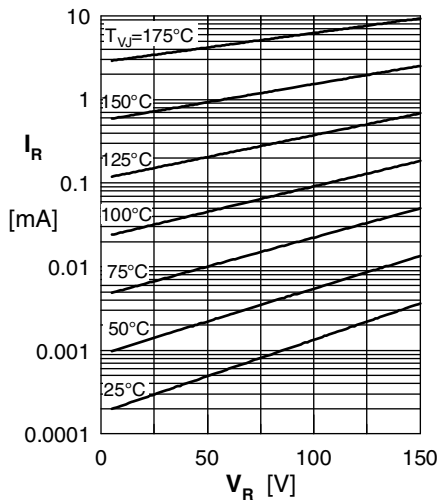

Fig. 2 Typ. reverse current I_R vs. reverse voltage V_R

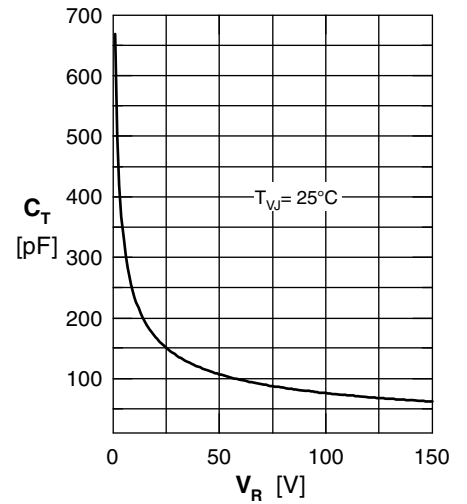

Fig. 3 Typ. junction capacitance C_T vs. reverse voltage V_R

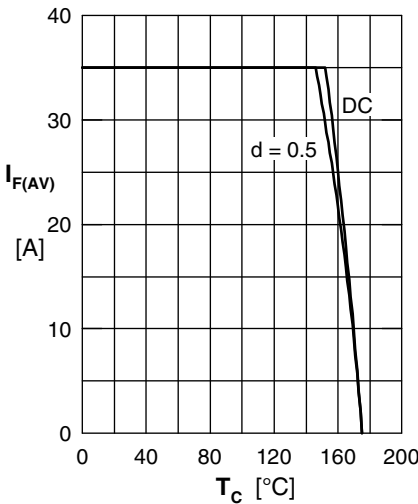

Fig. 4 Average forward current $I_{F(AV)}$ vs. case temperature T_C

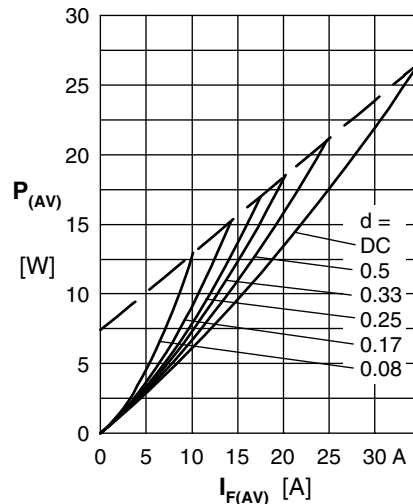

Fig. 5 Forward power loss characteristics

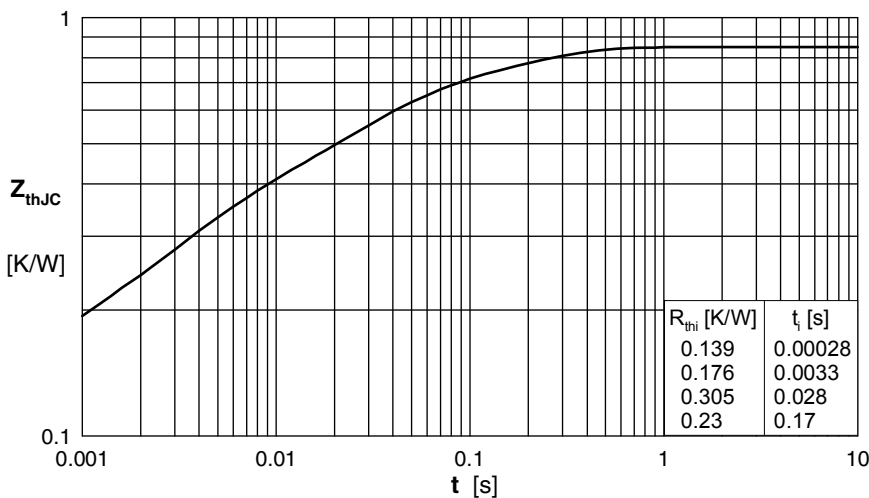

Fig. 6 Transient thermal impedance junction to case at various duty cycles

Note: All curves are per diode