

TEMPERATURE COMPENSATED ZENER DIODES

- SEMICONDUCTOR MATERIAL : SILICON
- TECHNOLOGY : LOCAL EPITAXY + GUARD RING

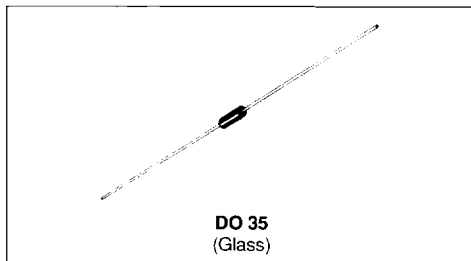

ABSOLUTE RATINGS (limiting values)

Symbol	Parameter	Value	Unit
P_{tot}	Power Dissipation* $T_{amb} = 50\text{ }^{\circ}\text{C}$	0.4	W
T_{stg} T_j	Storage and Junction Temperature Range	- 65 to 175 - 65 to 175	$^{\circ}\text{C}$ $^{\circ}\text{C}$
T_L	Maximum Lead Temperature for Soldering during 10s at 4mm from Case	230	$^{\circ}\text{C}$

THERMAL RESISTANCE

Symbol	Parameter	Value	Unit
$R_{th(j-a)}$	Junction - ambient*	300	$^{\circ}\text{C}/\text{W}$

ELECTRICAL CHARACTERISTICS ($T_{amb} = 25^{\circ}\text{C}$ unless otherwise specified)

Types	V_{ZT} typ. (V)	R_{ZT} @ I_{ZT} max. (Ω) (mA)		Test Temperatures				ΔV_Z^{**} max. (mV)	αV_Z ($10^{-6}/^{\circ}\text{C}$)	
				($^{\circ}\text{C}$)						
1N 4565	6.4	200	0.5	0	+ 25	+ 75	48	100		
1N 4566	6.4	200	0.5	0	+ 25	+ 75	24	50		
1N 4567	6.4	200	0.5	0	+ 25	+ 75	10	20		
1N 4568	6.4	200	0.5	0	+ 25	+ 75	5	10		
1N 4569	6.4	200	0.5	0	+ 25	+ 75	2	5		
1N 4565 A	6.4	200	0.5	- 55	0	+ 25	+ 75	+ 100	99	100
1N 4566 A	6.4	200	0.5	- 55	0	+ 25	+ 75	+ 100	50	50
1N 4567 A	6.4	200	0.5	- 55	0	+ 25	+ 75	+ 100	20	20
1N 4568 A	6.4	200	0.5	- 55	0	+ 25	+ 75	+ 100	10	10
1N 4569 A	6.4	200	0.5	- 55	0	+ 25	+ 75	+ 100	5	5

* On infinite heatsink with $d = 4\text{mm}$

** The voltage reference diodes are characterized by the box method. The maximum allowable voltage change ΔV_Z is guaranteed any two temperature within the range. Tests are performed at the indicated temperatures and the specified current.

1N 4565, A → 1N 4584, A

ELECTRICAL CHARACTERISTICS ($T_{amb} = 25^{\circ}\text{C}$ unless otherwise specified) (continued)

Types	V_{ZT} typ. (V)	R_{ZT} @ max. (Ω)	I_{ZT} (mA)	Test Temperatures			ΔV_{Z}^{**} max. (mV)	αV_Z ($10^{-6}/^{\circ}\text{C}$)
				($^{\circ}\text{C}$)				
1N 4570	6.4	100	1	0	+ 25	+ 75	48	100
1N 4571	6.4	100	1	0	+ 25	+ 75	24	50
1N 4572	6.4	100	1	0	+ 25	+ 75	10	20
1N 4573	6.4	100	1	0	+ 25	+ 75	5	10
1N 4574	6.4	100	1	0	+ 25	+ 75	2	5
1N 4570 A	6.4	100	1	- 55	0	+ 25 + 75 + 100	99	100
1N 4571 A	6.4	100	1	- 55	0	+ 25 + 75 + 100	50	50
1N 4572 A	6.4	100	1	- 55	0	+ 25 + 75 + 100	20	20
1N 4573 A	6.4	100	1	- 55	0	+ 25 + 75 + 100	10	10
1N 4574 A	6.4	100	1	- 55	0	+ 25 + 75 + 100	5	5
1N 4575	6.4	50	2	0	+ 25	+ 75	48	100
1N 4576	6.4	50	2	0	+ 25	+ 75	24	50
1N 4577	6.4	50	2	0	+ 25	+ 75	10	20
1N 4578	6.4	50	2	0	+ 25	+ 75	5	10
1N 4579	6.4	50	2	0	+ 25	+ 75	2	5
1N 4575 A	6.4	50	2	- 55	0	+ 25 + 75 + 100	99	100
1N 4576 A	6.4	50	2	- 55	0	+ 25 + 75 + 100	50	50
1N 4577 A	6.4	50	2	- 55	0	+ 25 + 75 + 100	20	20
1N 4578 A	6.4	50	2	- 55	0	+ 25 + 75 + 100	10	10
1N 4579 A	6.4	50	2	- 55	0	+ 25 + 75 + 100	5	5
1N 4580	6.4	25	4	0	+ 25	+ 75	48	100
1N 4581	6.4	25	4	0	+ 25	+ 75	24	50
1N 4582	6.4	25	4	0	+ 25	+ 75	10	20
1N 4583	6.4	25	4	0	+ 25	+ 75	5	10
1N 4584	6.4	25	4	0	+ 25	+ 75	2	5
1N 4580 A	6.4	25	4	- 55	0	+ 25 + 75 + 100	99	100
1N 4581 A	6.4	25	4	- 55	0	+ 25 + 75 + 100	50	50
1N 4582 A	6.4	25	4	- 55	0	+ 25 + 75 + 100	20	20
1N 4583 A	6.4	25	4	- 55	0	+ 25 + 75 + 100	10	10
1N 4584 A	6.4	25	4	- 55	0	+ 25 + 75 + 100	5	5

** The voltage reference diodes are characterized by the box method. The maximum allowable voltage change ΔV_Z is guaranteed any two temperature within the range. Tests are performed at the indicated temperatures and the specified current.

PACKAGE MECHANICAL DATA

DO 35 Glass

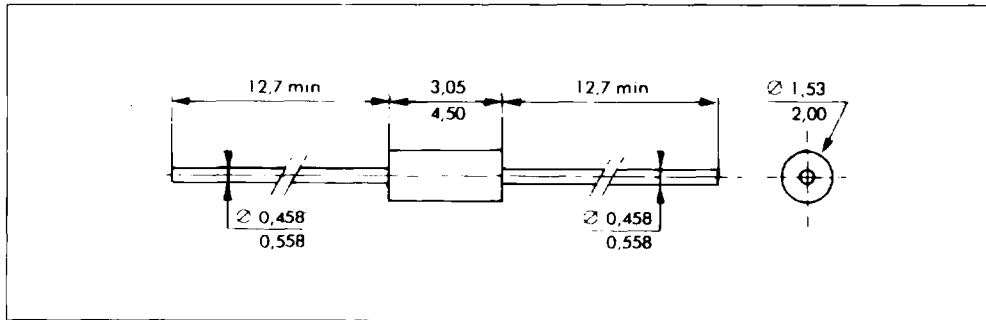

Cooling method : by convection and conduction.

Marking : clear, ring at cathode end.

Weight : 0.15g.

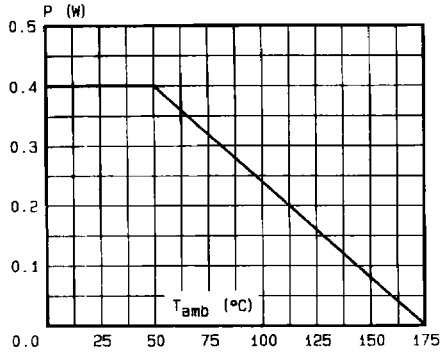

Fig.1 - Power dissipation versus ambient temperature.

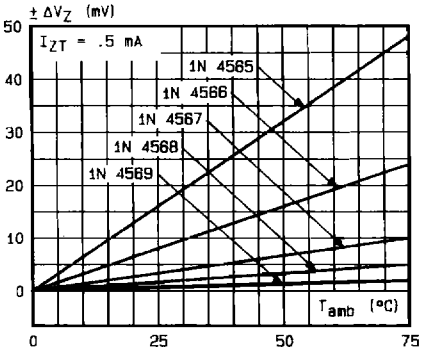

Fig.2a - Regulation voltage variation versus ambient temperature.

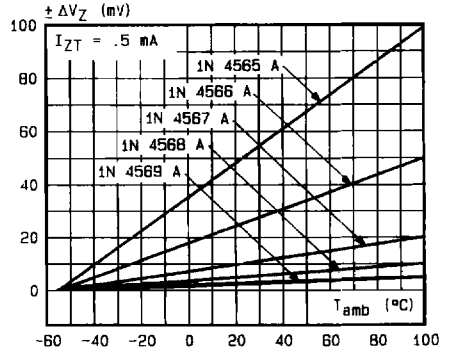

Fig.2b - Regulation voltage variation versus ambient temperature.

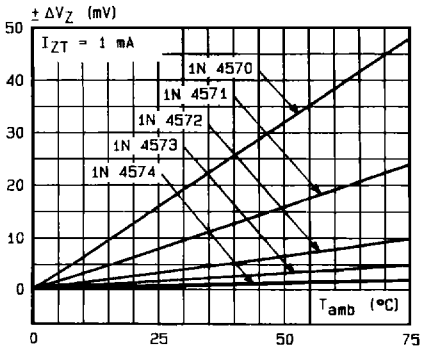

Fig.2c - Regulation voltage variation versus ambient temperature.

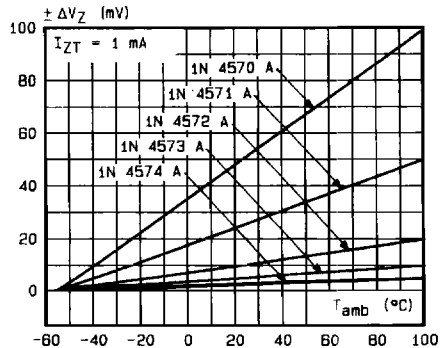

Fig.2d - Regulation voltage variation versus ambient temperature.

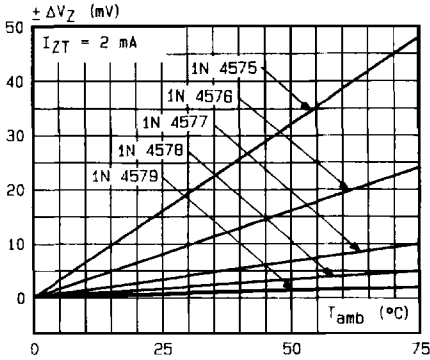

Fig.2e - Regulation voltage variation versus ambient temperature.

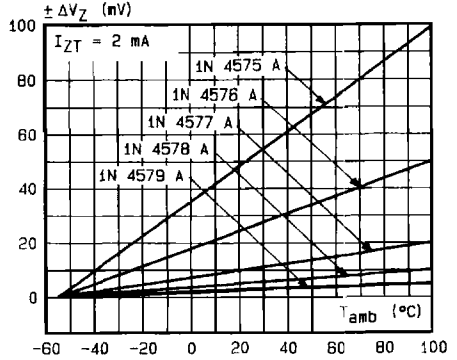

Fig.2f - Regulation voltage variation versus ambient temperature.

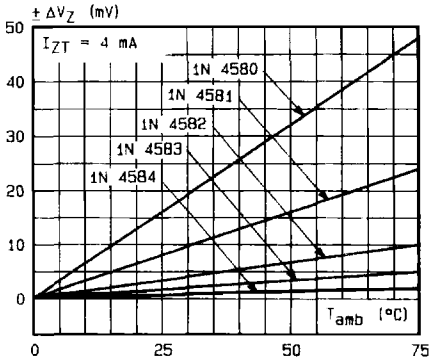

Fig.2g - Regulation voltage variation versus ambient temperature.

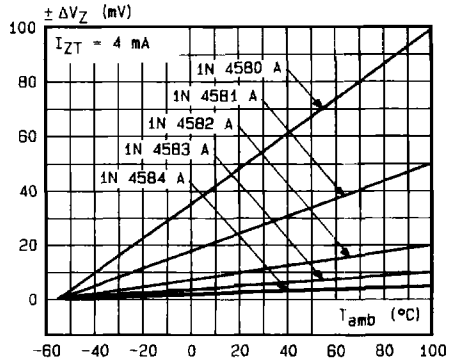

Fig.2h - Regulation voltage variation versus ambient temperature.