





SMT COMMON MODE INDUCTORS

0.5A to 3.6A



-  Pick and place compatible
-  Rated voltage 250V_{AC}
-  Low RFI toroid
-  Tape & Reel packaging available

Electrical Specifications @ 25°C — Operating Temperature -40°C to +130°C³

Part ^{1,2} Number	Inductance (mH MIN)	I _{rated} (A)	DCR (MAX) (mΩ)	Typical SRF (MHz)	Impedance Curve	Size Code	Weight (Grams)	Quantity In Tube
PE-53914NL	13.2	0.50	850	0.3	5	LCCI-37	2.4	30
PE-53913NL	6.0	1.00	450	0.5	4	LCCI-37	2.4	30
PE-53912NL	1.8	2.50	80	2.2	3	LCCI-50	5.2	30
PE-53911NL	0.9	1.50	60	2	2	LCCI-37	2.5	30
PE-53910NL	0.6	3.60	50	4	1	LCCI-50	5.3	30

NOTE:

- Optional Tape & Reel packaging can be ordered by adding a "T" suffix to the part number (i.e. PE-53914L becomes PE-53914LT). Pulse complies to industry standard tape and reel specification EIA481.
- The "NL" suffix indicates an RoHS-compliant part number. Non-NL suffixed parts are not necessarily RoHS compliant, but are electrically and mechanically equivalent to NL versions. If a part number does not have the "NL" suffix, but an RoHS compliant version is required, please contact Pulse for availability.
- The temperature of the component (ambient plus temperature rise) must be within the stated operating temperature range.

Mechanical

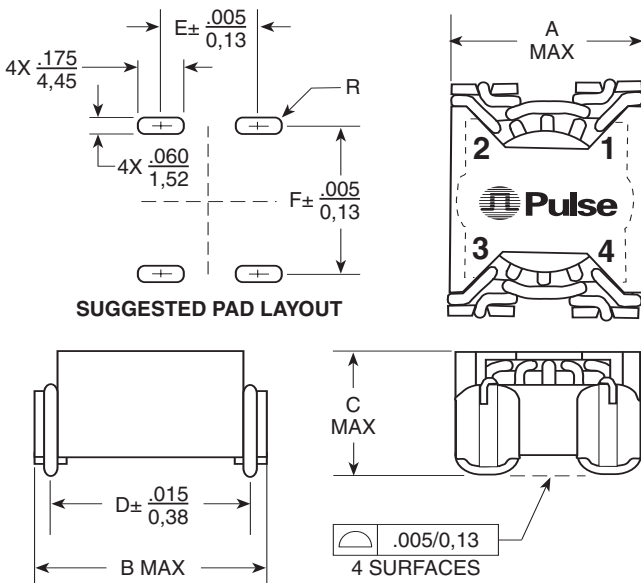

Schematic

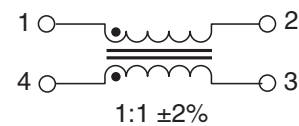

Typical Impedance Curves

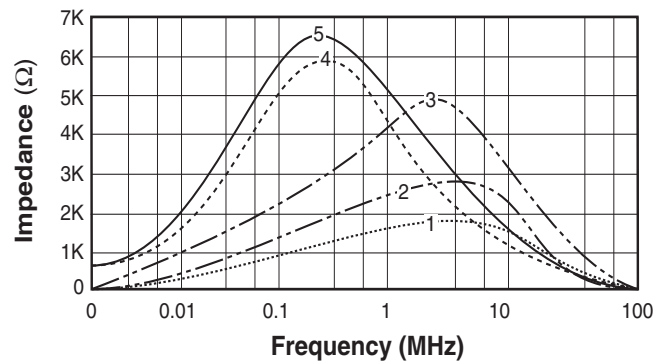

Dimensions: $\frac{\text{Inches}}{\text{mm}}$

Unless otherwise specified, all tolerances are $\pm \frac{.010}{.025}$

Size	A	B	C	D	E	F
LCCI-37	.560/14,22	.645/16,38	.350/8,89	.520/13,21	.340/8,64	.530/13,46
LCCI-50	.670/17,02	.770/19,56	.390/9,90	.650/16,51	.445/11,30	.660/16,76