



## Domestic Air conditioner

# ***TECHNICAL DATA***

## **ON/OFF**

### Wall mounted Type Arc-Series

HSU-14HR03/R2

HSU-18HR03/R2

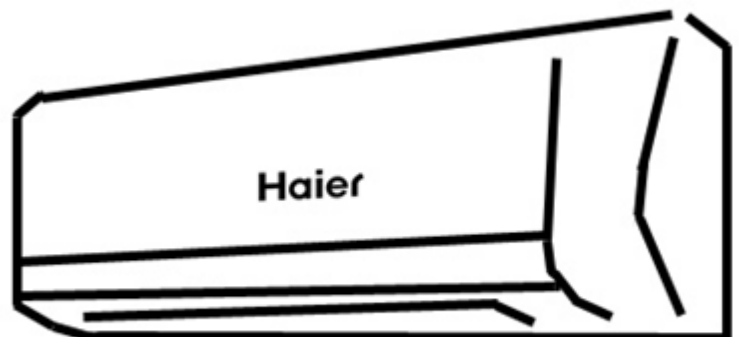







## CAUTION

1. READ THIS MANUAL CAREFULLY TO  
DIAGNOSE TROUBLE CORRECTLY  
BEFORE OFFERING SERVICE.
2. THIS MANUAL IS USED BY QUALIFIED  
APPLIANCE TECHNICIANS ONLY.
3. HAIER DOES NOT ASSUME ANY  
RESPONSIBILITY FOR PROPERTY  
DAMAGE OR PERSONAL INJURY FOR  
IMPROPER  
SERVICE PROCEDURES DONE BY ONE  
UNQUALIFIED PERSON.

# Table of Contents

<b>1. Features</b> .....	2
<b>2. Specifications</b> .....	3
<b>3. Remote controller lists</b> .....	6
<b>4. Sensors lists</b> .....	6
<b>5. Dimensional drawings</b> .....	7
<b>6. Operation range</b> .....	9
<b>7. Piping diagrams</b> .....	10
<b>8. Wiring diagrams</b> .....	11
<b>9. Capacity diagrams and curves diagrams</b> .....	13
<b>10. Sound level</b> .....	17
<b>11. Accessories</b> .....	19
<b>12. Control systems</b> .....	20
<b>13. Center of gravity</b> .....	21
<b>14. Installations</b> .....	23

# 1 Features

-  DRY function: Make dehumidifying in the room when the unit is working in the "DRY" mode
-  Sleep mode: The setting temperature and the indoor noise can be adjusted to a more comfortable level when you set the "sleep mode" during night sleep
-  24 Hour timer: Use the timer function to set on, or off, or from on to off, or from off to on
-  Auto restart: The function permits automatic return to previous operation conditions
-  Easy clean design: The panel is easy to wash and the airflow vents can be detached without any special tools for quick cleaning of the inside of the air conditioner
-  Auto mode According to the fixed temperature "26°C", the unit will adjust the operation mode automatically.



## 2 Specifications

\* This information was not available at the time of publication.

NOMINAL INPUT					
For indoor units only:					
INDOOR UNITS			HSU-14HR03/R2		HSU-18HR03/R2
NOMINAL INPUT	Cooling	nominal	kW	0.08	0.1
	Heating	nominal	kW	0.08	0.1

NOMINAL CAPACITY and NOMINAL INPUT					
Model				HSU-14HR03/R2	HSU-18HR03/R2
NOMINAL CAPACITY(3-4)	Cooling(1)	norm.	kW	4.0	5.0
	Heating(2)	norm.	kW	4.4	5.5
NOMINAL INPUT	Cooling	norm	kW	1.30	1.66
	Heating	norm.	kW	1.28	1.78
EER	Cooling			3.08	3.01
COP	Heating			3.44	3.09
ENERGY LABEL(7-8)	Cooling			--	--
	Heating			--	--
ANNUAL ENERGY CONSUMPTION(9)	Cooling		kwh	600	725

TECHNICAL SPECIFICATIONS						
INDOOR UNITS				HSU-14HR03/R2	HSU-18HR03/R2	
DIMENSIONS	Unit	H	mm	222		
		W	mm	265		
		D	mm	938		
WEIGHT	Unit		kg	10.6		
COLOR	Unit		white			
SOUND LEVEL	Sound pressure (cooling/heating)(5)	high	dB(A)	47/47	52/52	
		medium	dB(A)	44/43	51/51	
		low	dB(A)	41/40	50/50	
	Sound power(cooling/heating)(6)	high	dB(A)	55/55	60/58	
FAN	Air flow rate(cooling/heating)	high	m <sup>3</sup> /min	9.1/10	10.8/11.3	
		medium	m <sup>3</sup> /min	8.0/8.5	9.10/9.20	
		low	m <sup>3</sup> /min	7.2/7.5	7.8 /8.2	
	Speed(cooling/heating)	steps		4steps,auto		
		high	rpm	1250/1250	1350/1350	
		medium	rpm	1150/1150	1250/1250	
		low	rpm	950/950	1100//1100	
Type	Cross flow fan					
Motor output	W		30			
HEAT EXCHANGER	Type		ML - Φ 9.52Hi - XA tube			
	Rows x stages x fin pitch		2 x 10 x 1.4			
AIR FILTER	Removable/washable/mildew proof					
REMOTE CONTROLLER	YR-H10					
TEMPERATURE CONTROL	Microcomputer control					
PIPING CONNECTIONS(external diameter)	liquid	mm		6.35		
	gas	mm		12.7		
	drain	mm		16		
INSULATION MATERIAL	Heat insulation type			both liquid and gas pipes		

TECHNICAL SPECIFICATIONS					
OUTDOOR UNITS				HSU-14HR03/R2	HSU-18HR03/R2
NET DIMENSIONS (stop valve, and bottom support is not included)	Unit	H	mm	540	650
		W	mm	245	245
		D	mm	780	780
WEIGHT	Unit		kg	44	45
COLOR	Unit	white			
SOUND LEVEL	Sound pressure(cooling/heating)(5)	high	dB(A)	55/54	60/58
	Sound power(cooling/heating)(6)	high	dB(A)	64/65	67/68
FAN	Air flow rate(cooling/heating)	high	m <sup>3</sup> /min	36/34	36/34
		low	m <sup>3</sup> /min	---	---
	Speed(cooling/heating)	high	rpm	850	850
		low	rpm	---	---
	Type	Propeller fan			
	Motor output		W	19	
HEAT EXCHANGER	Type	ML - $\Phi$ 9.52Hi - XA tube			
	Rows x stages x fin pitch	2 x 10 x 1.4			
REFRIGERANT CIRCUIT	Refrigerant type			R410A	R410A
	Refrigerant charge		kg	1.10	1.35
	Maximum allowable distance between indoor and outdoor		m	15	15
	Maximum allowable level difference		m	20	20
	Refrigerant control	---			
COMPRESSOR	Type	Rotary Compressor			
	Model			TOSHIBA PA160X2C-4FT	HITACHI ASH201SV-C8LU
	Motor output		w	1350	1650
	Oil type			equivalent	esteroil vg74
	Oil charge volume		L	0.48	0.6
PIPING CONNECTIONS	liquid		mm	$\Phi$ 6.35	
	gas		mm	$\Phi$ 12.7	
	drain		mm	$\Phi$ 16	
INSULATION MATERIAL	Heat insulation type			both liquid and gas pipes	

ELECTRICAL SPECIFICATIONS					
For combination indoor units+ outdoor units:				HSU-14HR03/R2	HSU-18HR03/R2
CURRENT	Nominal	cooling	A	5.9	7.5
	running current	heating	A	5.8	8.0
	Maximum	cooling	A	7.5	9.0
	running current	heating	A	8.2	10.0
	Starting current	cooling	A	39	39
		heating	A	39	39

For indoor units only:			HSU-14HR03/R2	HSU-18HR03/R2
POWER SUPPLY			VM	VM
NOMINAL DISTRIBUTION SYSTEM VOLTAGE	Phase		1PH	1PH
	Frequency	Hz	50	50
	Voltage	V	230	230

## NOTES

- 1 Nominal cooling capacities are based on: indoor temperature 27°CDB/19°CWB \* outdoor temperature 35°CDB \* refrigerant piping length: 5m \* level difference: 0m.
- 2 Nominal heating capacities are based on: indoor temperature 20°CDB \* outdoor temperature 7°CDB/6°CWB \* refrigerant piping length 5m (horizontal) \* level difference 0m.
- 3 Capacities are net, including a deduction for cooling (an addition for heating) for indoor fan motor heat.
- 4 Units should be selected on nominal capacity. Maximum capacity is limited to peak periods.
- 5 The sound pressure level is measured in an anechoic room at 1m distance from the unit. It is a relative value, depending on the distance and acoustic environment. For measuring conditions: please refer to item 8 of this chapter.
- 6 The sound power level is an absolute value indicating the "power" which a sound source generates.
- 7 Energy label: scale from A (most efficient) to G (less efficient).
- 8 The energy label Directive 2002/31/EC will enter into force once the relevant measurement standard will be published in the European official Standard.
- 9 Annual energy consumption: based on average use of 500 running hours per year at full load (= nominal conditions)

### 3 Remote controller lists

Model	HSU-14HR03/R2	HSU-18HR03/R2
YR-H10	Y	Y

### 4 Sensors lists

INDOOR UNIT		
type	Description	Qty
Room sensor	It's used for detecting room temperature	1
Pipe sensor	It's used for detecting temperature of evaporator	1

# 5 Dimensional drawings

HSU-14HR03/R2 Indoor unit

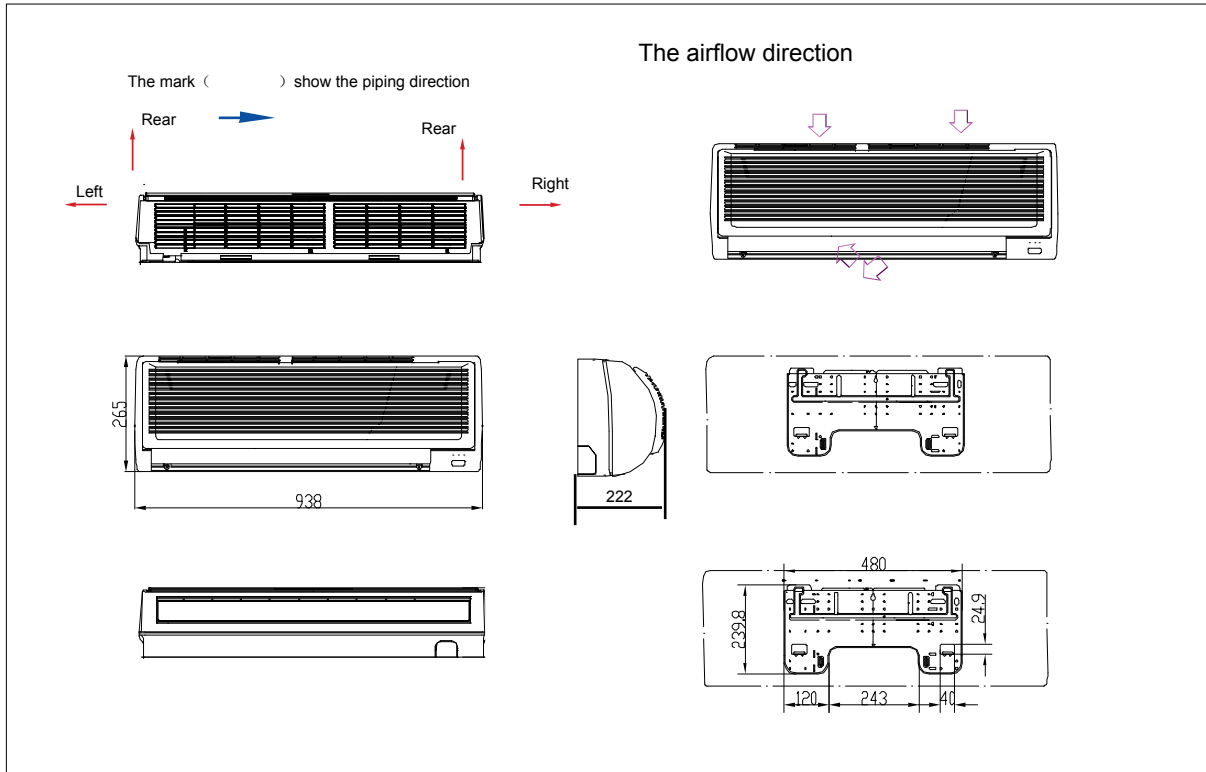

HSU-14HR03/R2 Outdoor unit

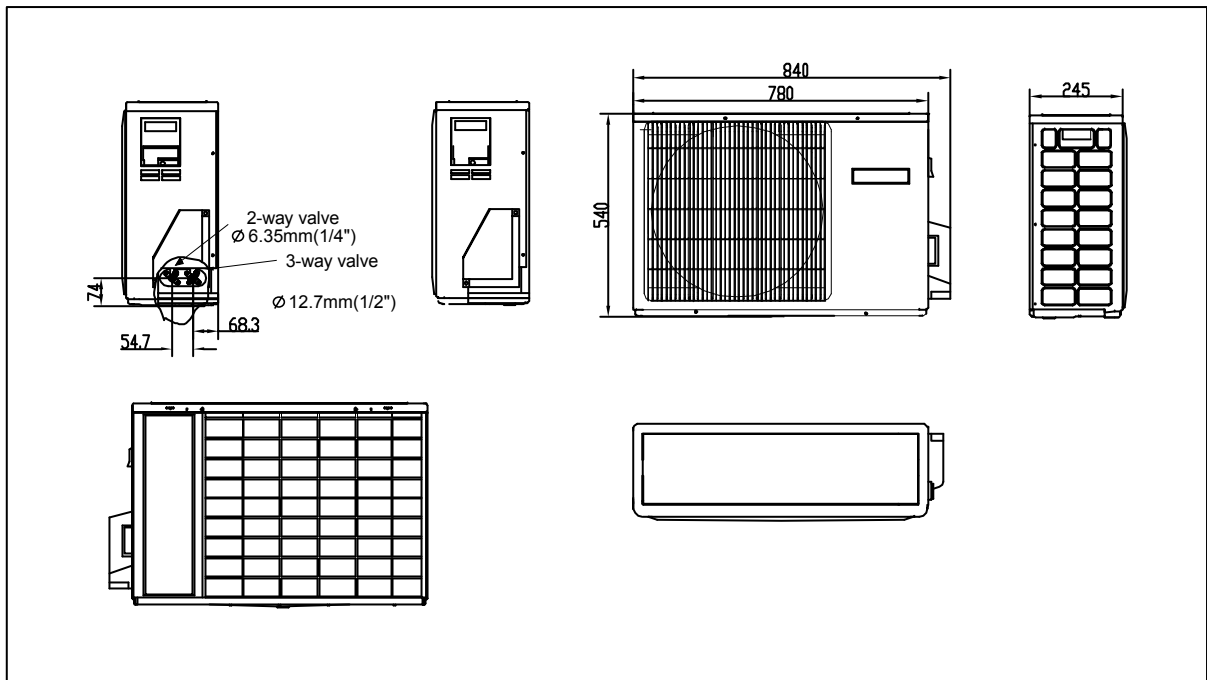



# Dimensional drawings

## HSU-18HR03/R2 Indoor unit

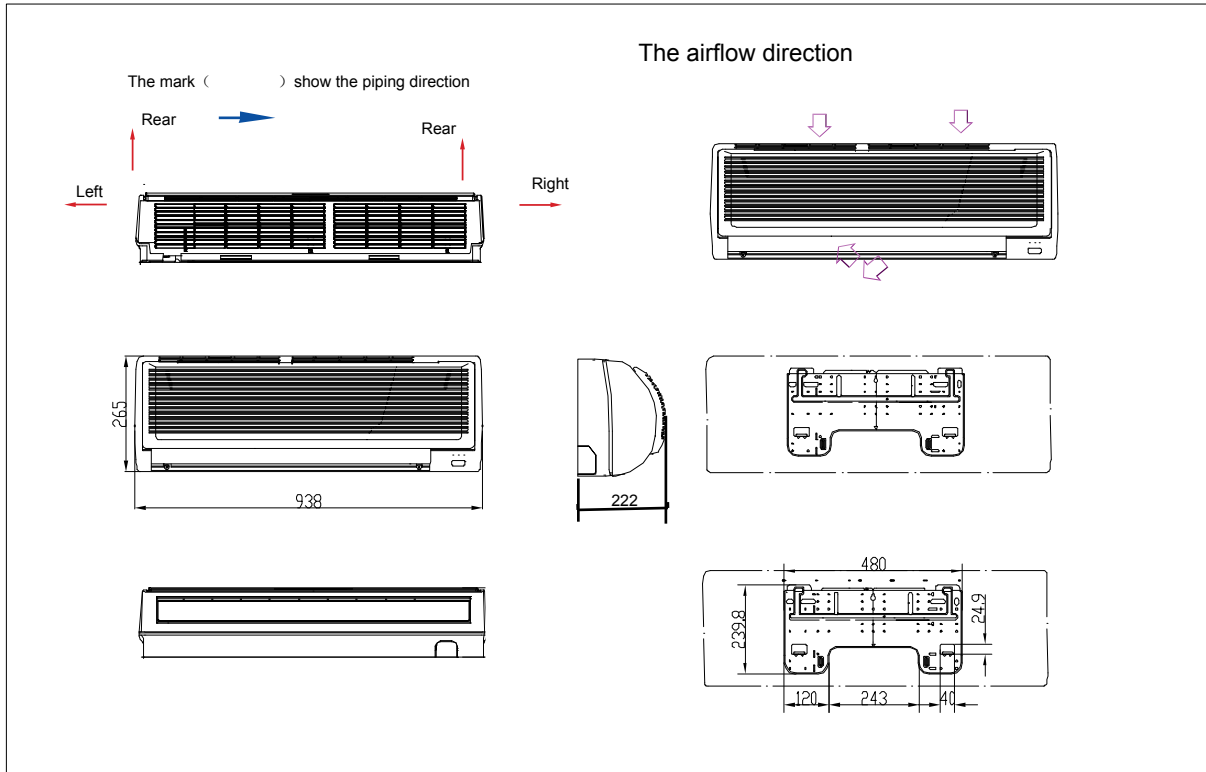

## HSU-18HR03/R2 Outdoor unit

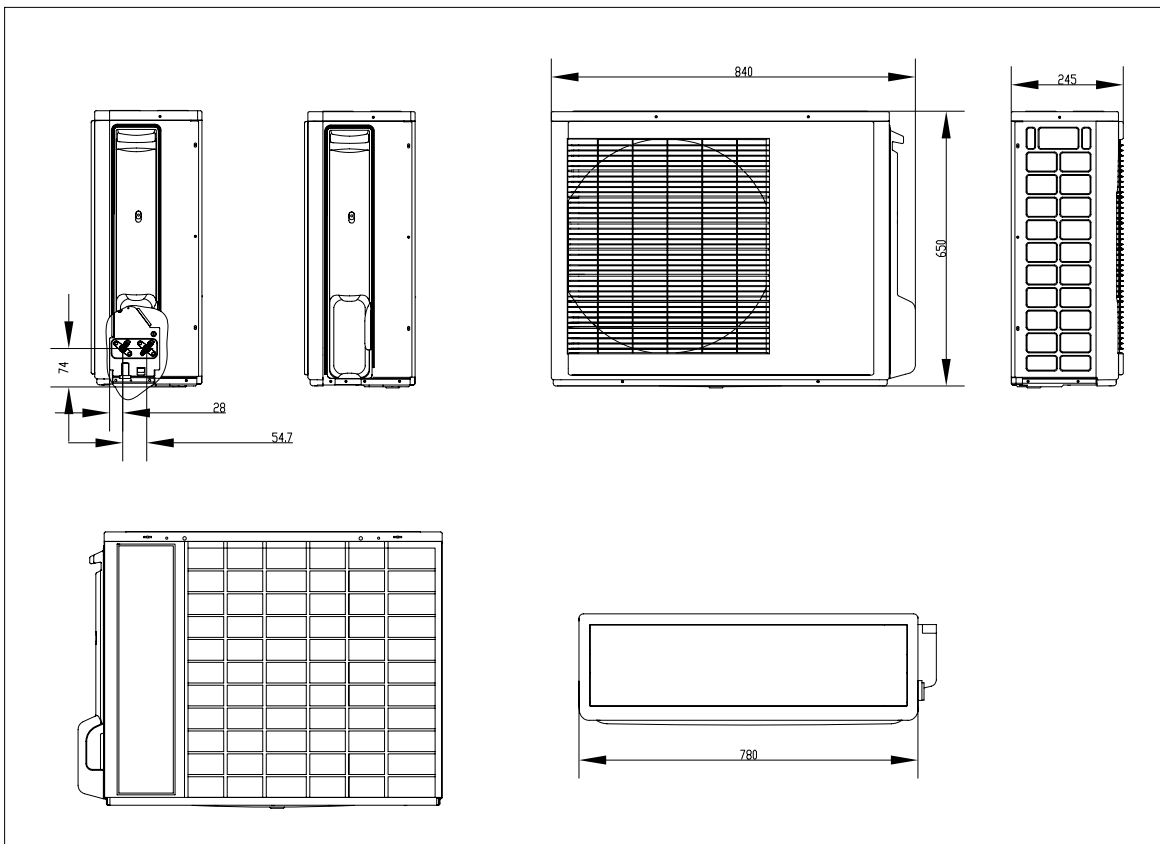

# 6 Operation range

The name of parts

Cooling

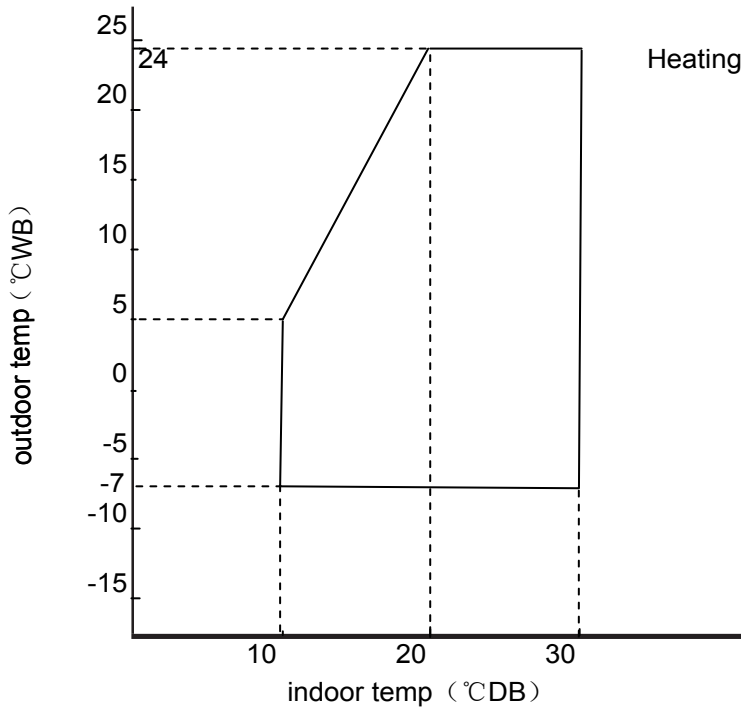
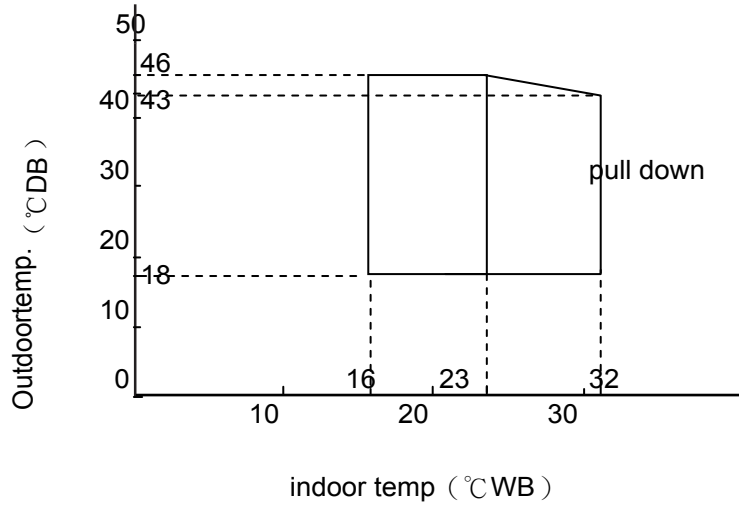

Notes:

The graphs are based on the following condition:  
 Equivalent piping length      7.5m  
 Level difference                      0m  
 Air flow rate                            high

# 7 Piping diagrams

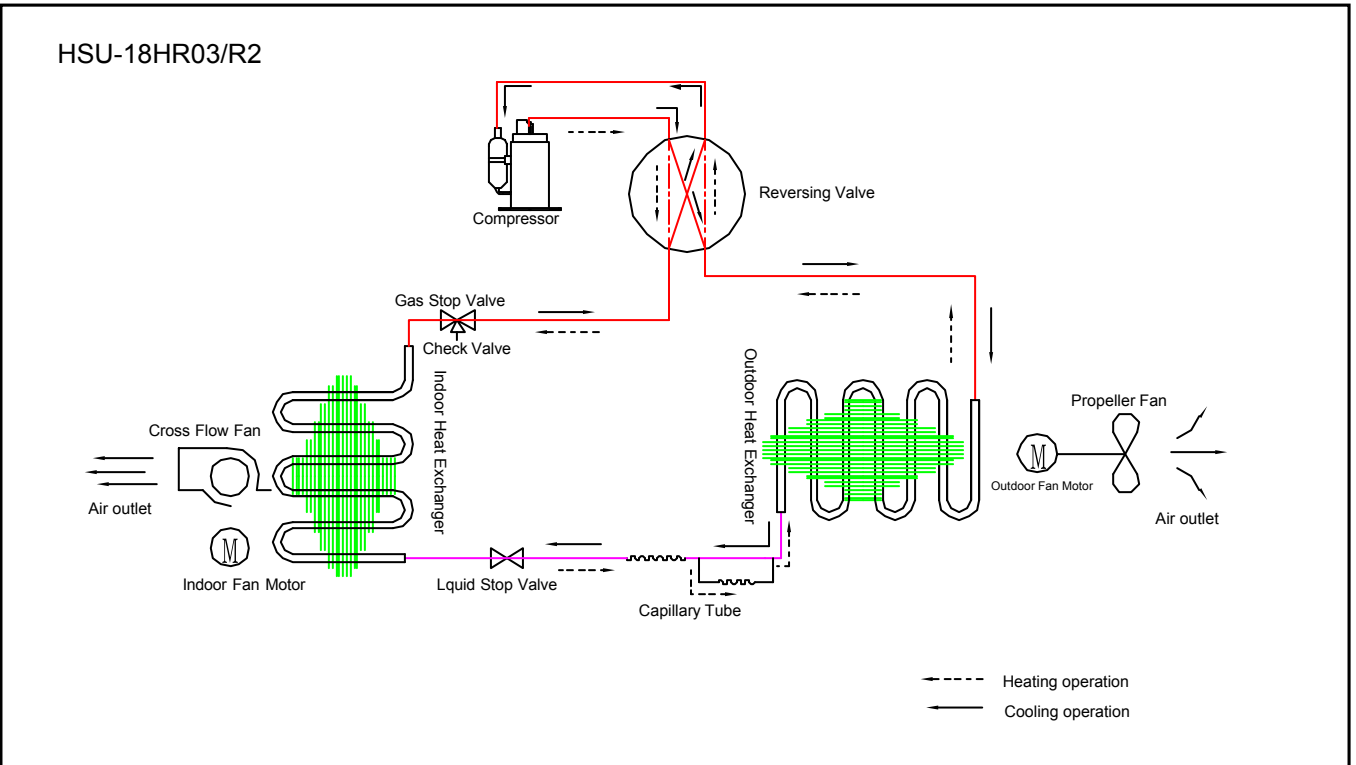
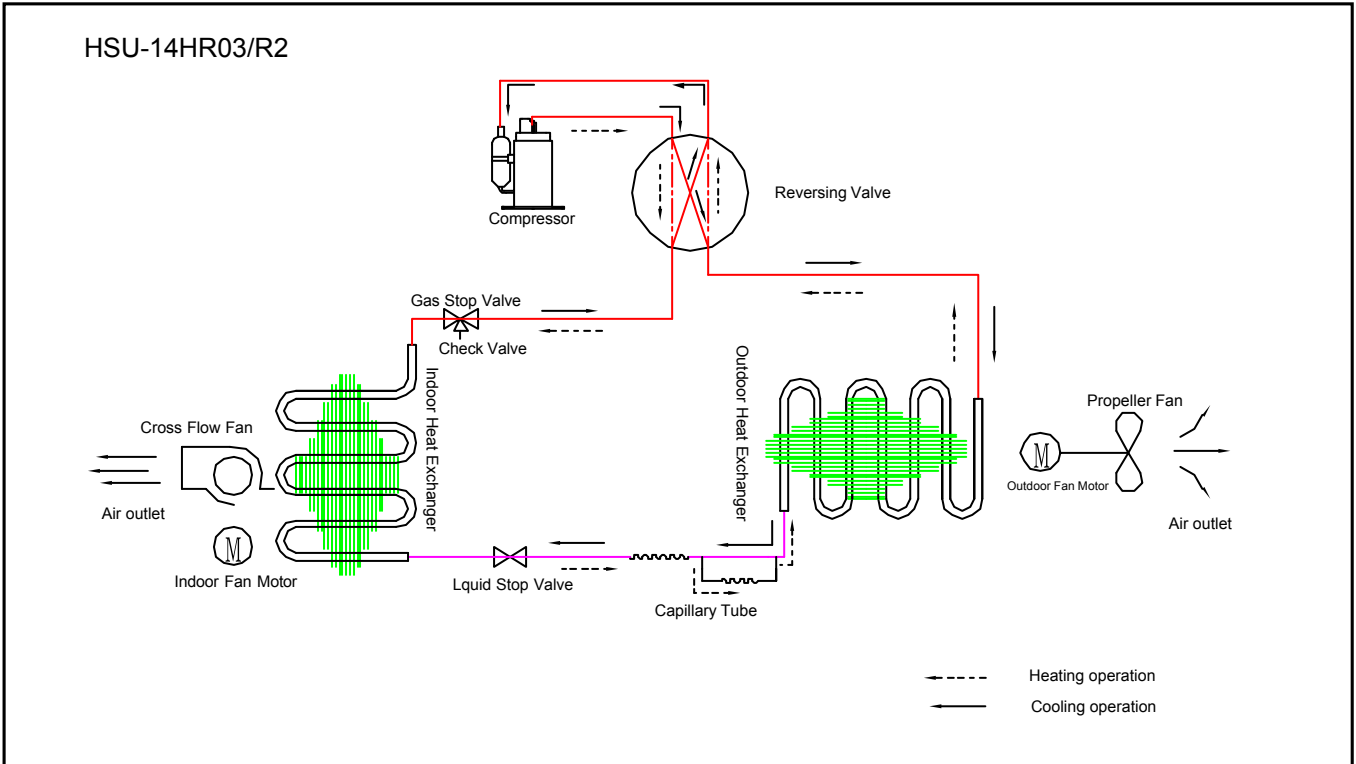

# 8 Wiring diagrams

HSU-14HR03/R2

HSU-18HR03/R2

Indoor Unit

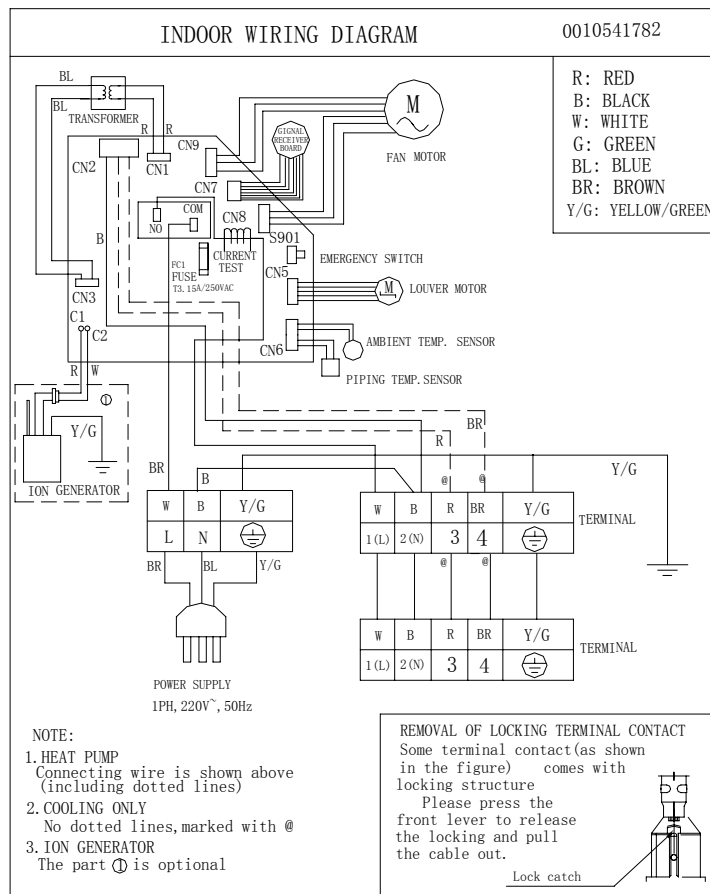

# Outdoor Unit

HSU-14HR03/R2

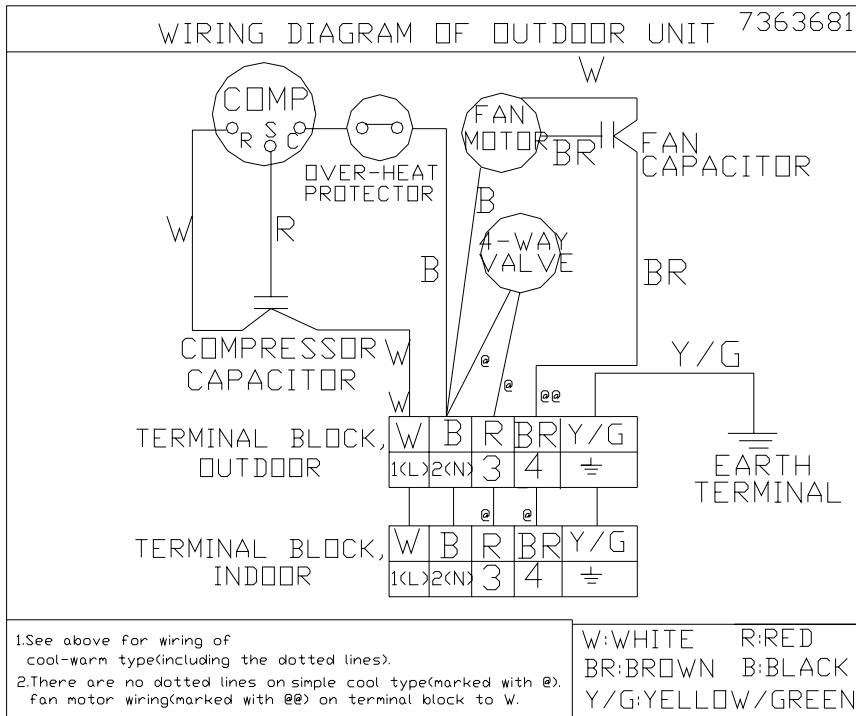

HSU-18HR03/R2

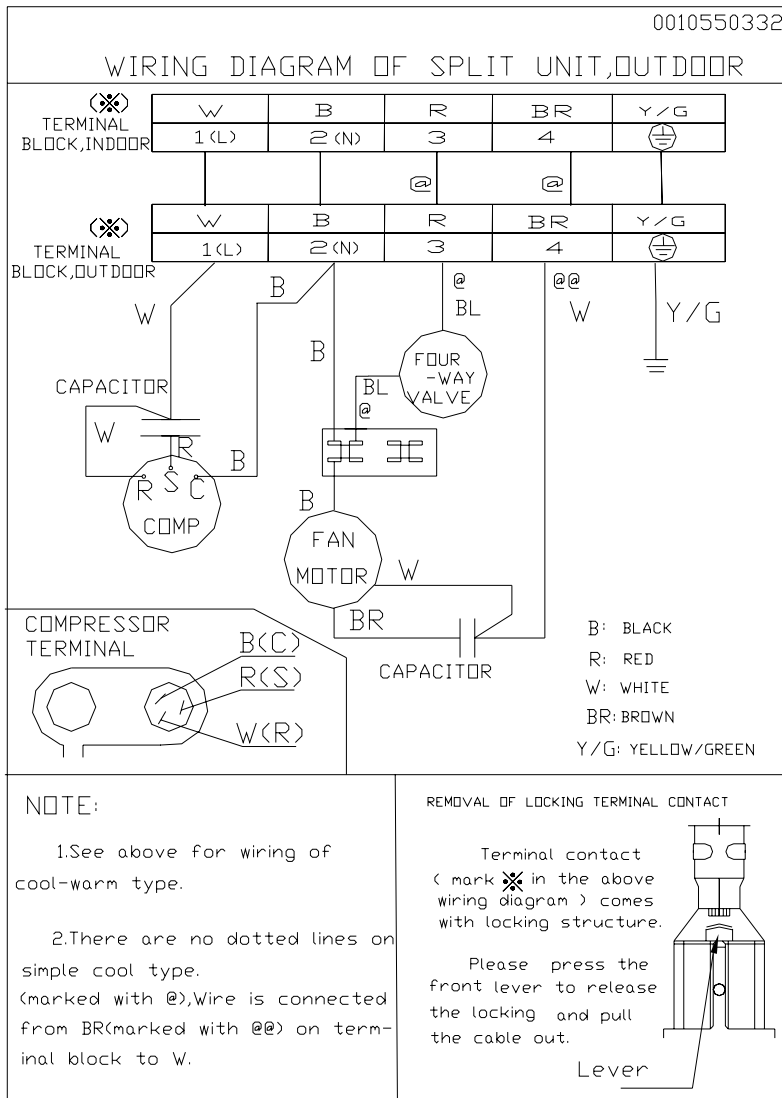

HSU-14HR03/R2 performance curves								
cooling value-temperature talbe								
indoor temp.	outdoor temp. (humidity 46%)							
DB/WB	18°C	20°C	25°C	32°C	35°C	40°C	43°C	46°C
18/12°C	2568	2579	2591	2353	2364	2410	2249	2124
18/14°C	3086	3099	3170	2900	2860	2720	2600	2508
20/15°C	3604	3618	3632	3530	3357	3183	3037	2891
22/16°C	3547	3564	3581	3508	3321	3100	2950	2880
25/18°C	3489	3510	3530	3486	3286	3085	2953	2850
27/19°C	3769	3672	3726	3551	3436	3280	3148	3015
30/22°C	3857	3807	3759	3742	3655	3515	3330	3280
32/23°C	3985	3891	3800	3763	3702	3585	3447	3309
32/24°C	4000	3970	3875	3840	3778	3658	3518	3377

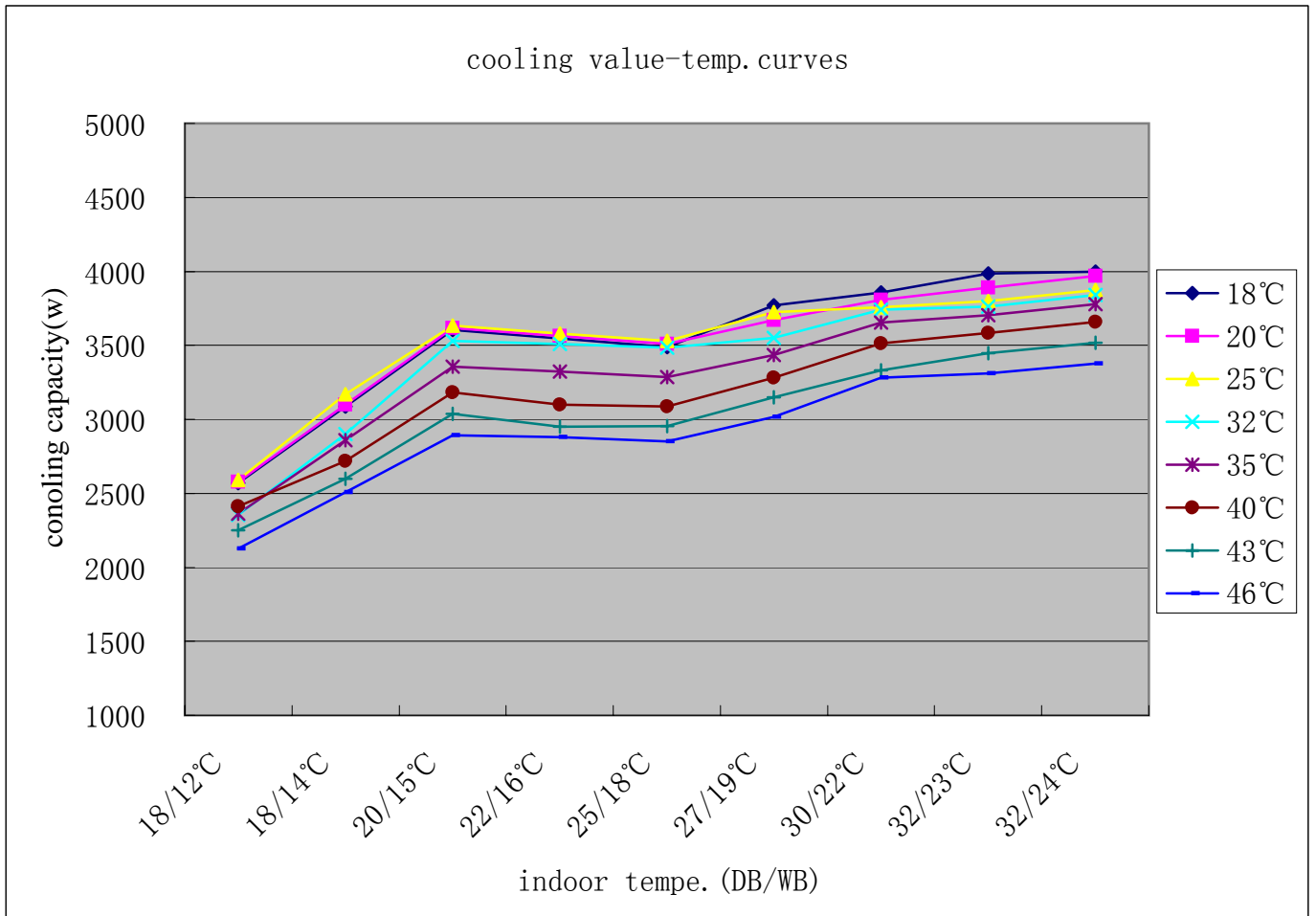

HSU-14HR03/R2 performance curves			
heating capacity and indoor/outdoor temp. curves			
outdoor temp.	indoor temp. (humidity 46%)		
DB/WB	15°C	20°C	25°C
-15°C	2011	1943	1853
-5°C	2790	2710	2596
5°C	2912	3078	2962
7/6°C	3640	3548	3203
15°C	4400	4340	3890
20°C	4287	4073	3664
25°C	3944	3847	3571

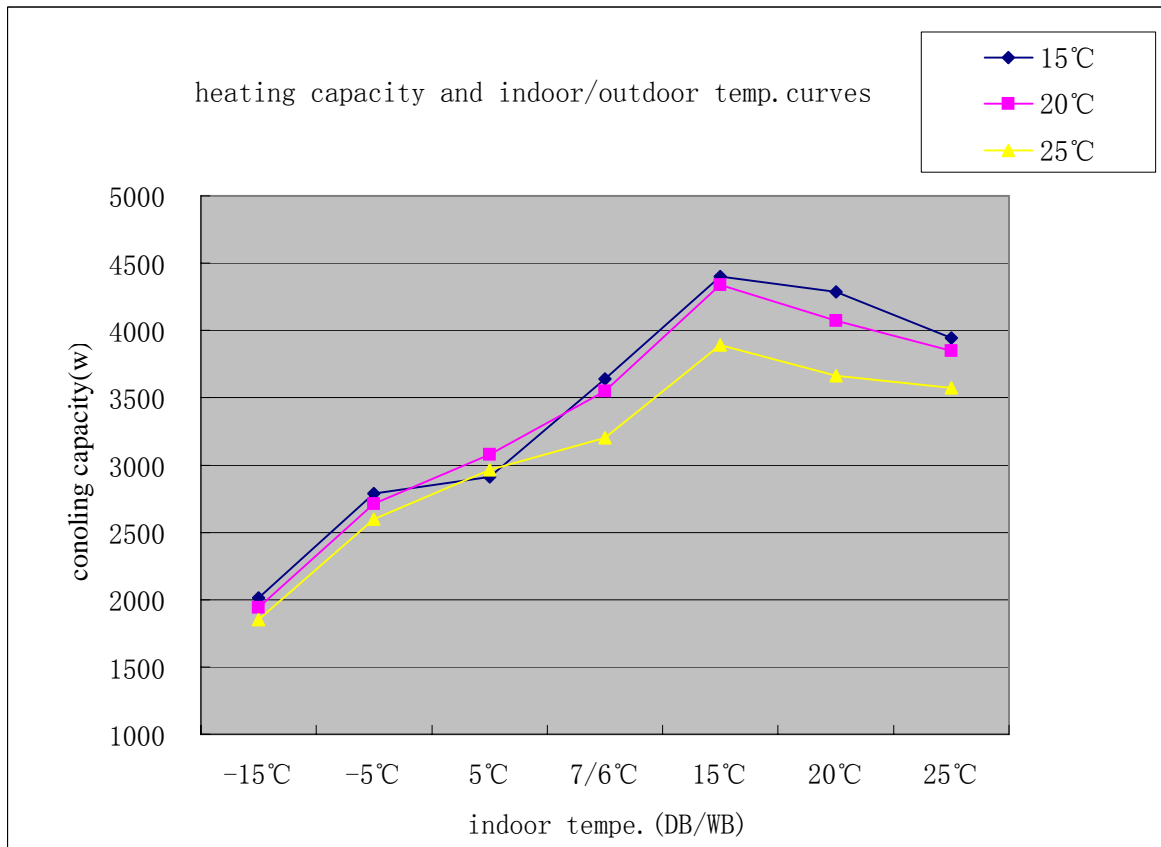

HSU-18HR03/R2 performance curves								
cooling capacity and indoor/outdoor temp.curves								
indoor temp.	outdoor temp.(humidity 46%)							
DB/WB	16 °C	20 °C	25 °C	32 °C	35 °C	40 °C	43 °C	46 °C
18/12 °C	3395	3362	3263	3196	2898	2587	2334	2234
18/14 °C	3676	3572	3466	3395	3003	2769	2478	2372
20/15 °C	3784	3681	3572	3499	3172	2907	2553	2444
22/16 °C	4036	3806	3742	3618	3279	3035	2639	2464
25/18 °C	4260	3989	3871	3792	3436	3235	2764	2535
27/19 °C	4482	4114	3984	3902	3659	3500	3111	2722
30/22 °C	4767	4493	4229	4143	3877	3692	3283	2889
32/23 °C	4821	4653	4447	4356	3947	3666	3340	3036
32/24 °C	4984	4722	4504	4391	3922	3637	3397	3181

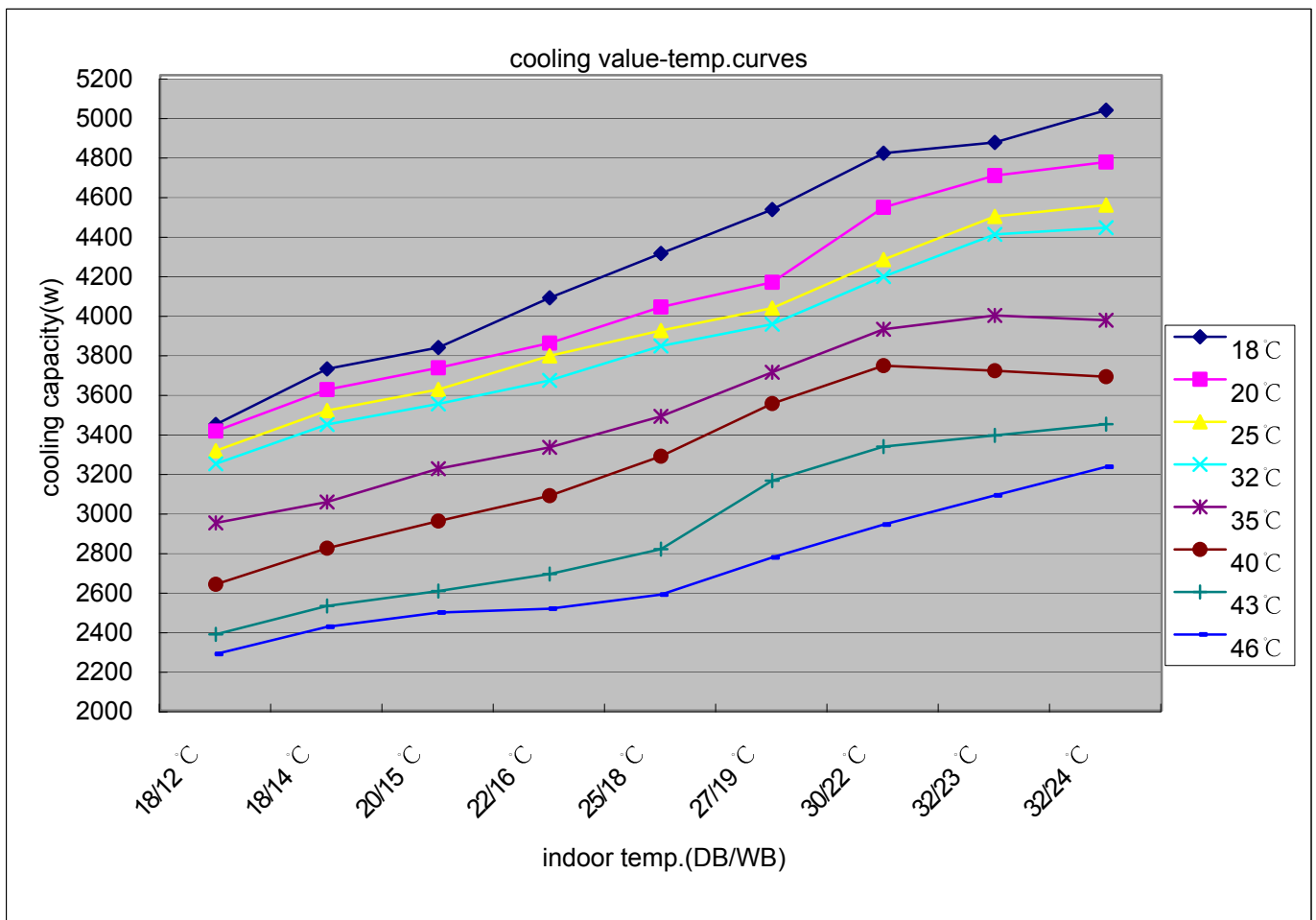



HSU-18HR03/R2 performance curves				
heating capacity and indoor/outdoor temp.curves				
outdoor temp.	indoor temp.(humidity 46%)			
DB/WB	20/15 °C	20/14.5 °C	20/12 °C	27/18 °C
-5 °C	3992	3929	3742	3350
0 °C	4388	4129	4075	3658
5 °C	4604	4345	4261	3836
7/6 °C	5002	4550	4486	4195
10 °C	5276	4966	4760	4384
15 °C	5329	5103	4986	4427
24 °C	5385	5132	4937	4466

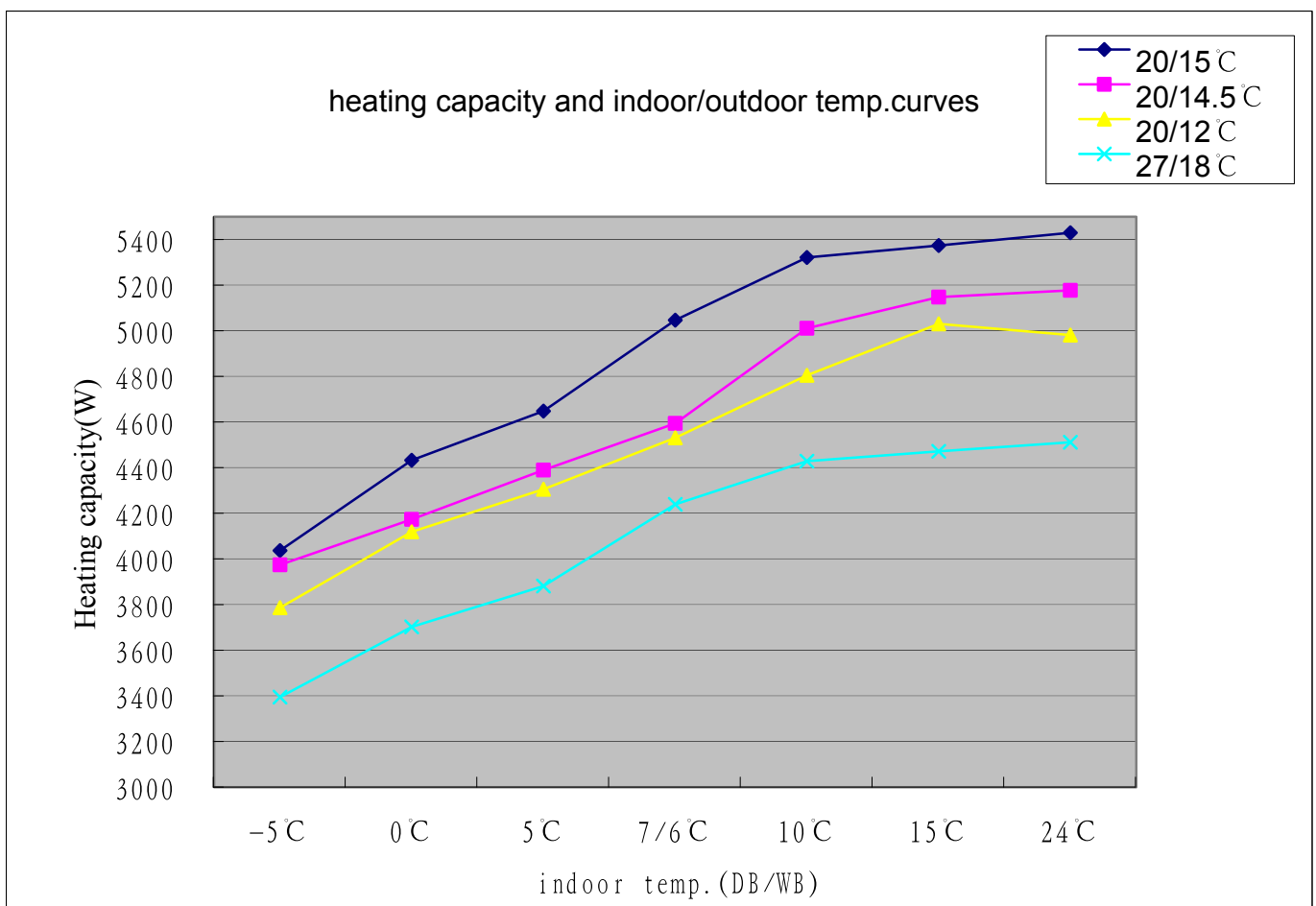

# 10 Sound level

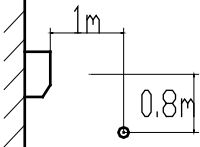
Model	Sound pressure level				sound power level (cooling/heating)
	230V,50Hz				
	Cooling/heating				
	H	L	SL		
HSU-14HR03/R2	44.2/42.0	42.1/40.2	36.9/33.8		54.7/54.9
HSU-18HR03/R2	46.2/44.3	44.1/41.7	40.5/37.5		57.0/58.3

## HSU-14HR03/R2

Cooling only

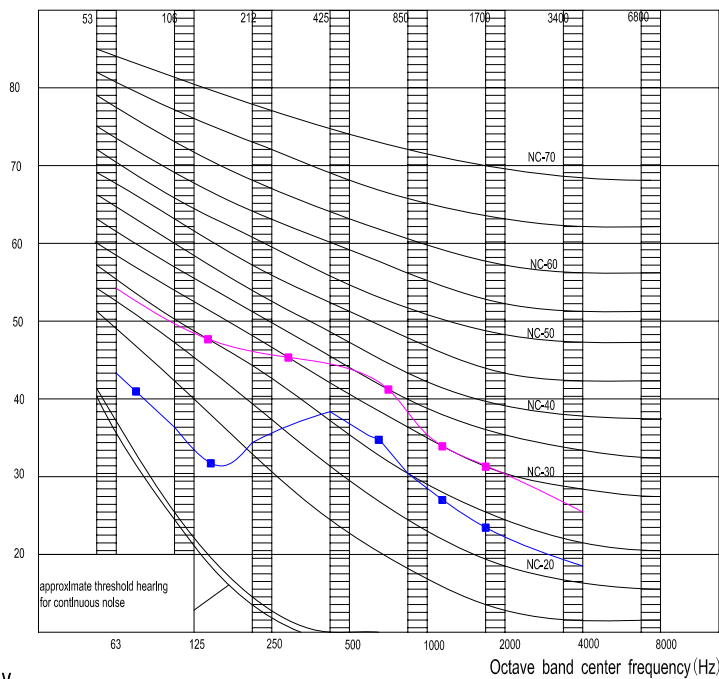

Heating only

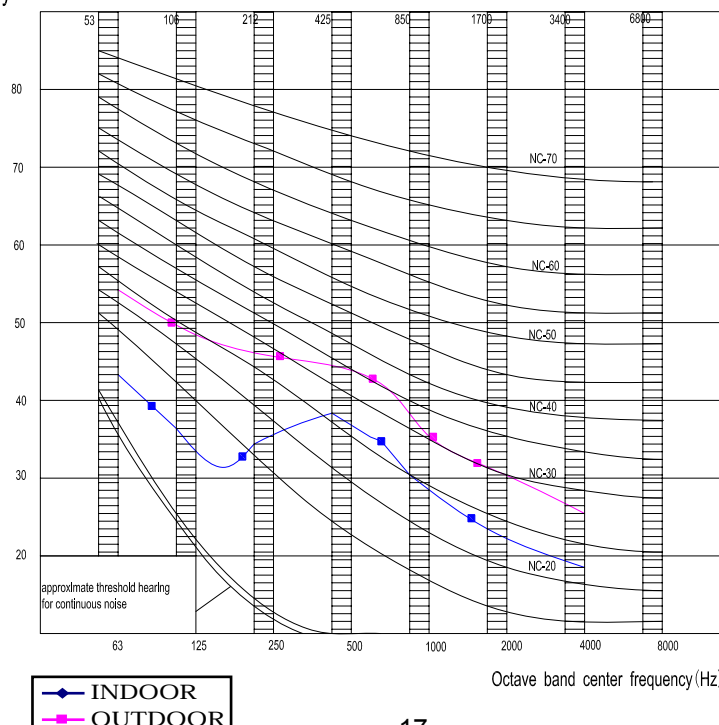

# Sound level

## HSU-18HR03/R2

cooling

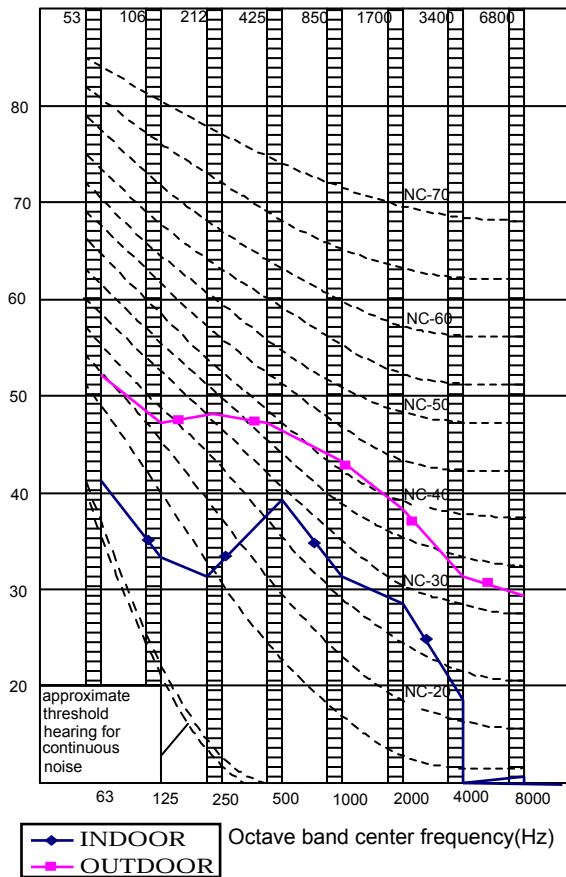

heating

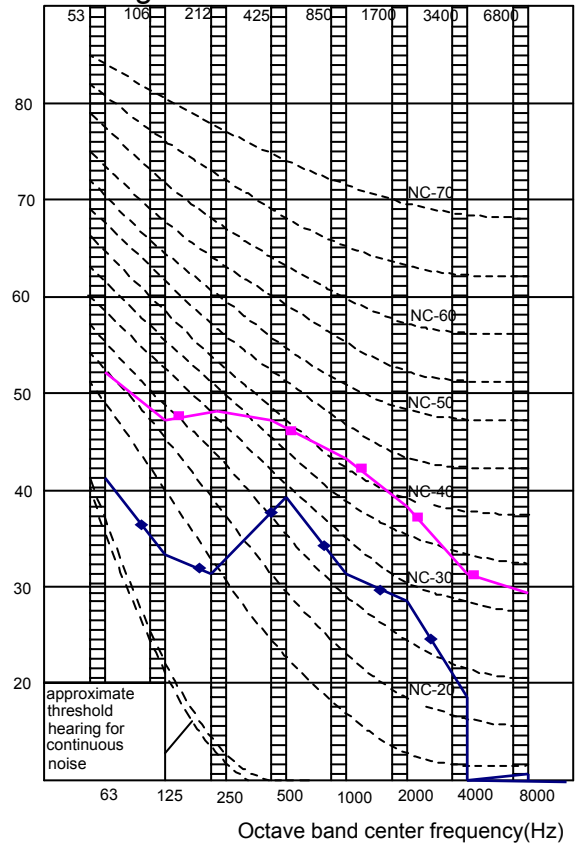

# 11 Accessories

Standard name	HSU-14HR03/R2	HSU-18HR03/R2
Drain hose	1	1
Plastic bag	1	1
screw assembly	1	1
Air purifier	2	2
Battery	2	2
Mounting plate	1	1
Remote controller	1	1
Installation manual	1	1
Operation manual	1	1

## 12 Control systems

Buttons and display of the remote controller.

If the unit which you purchased has not health function, remote controller should like the following figure:

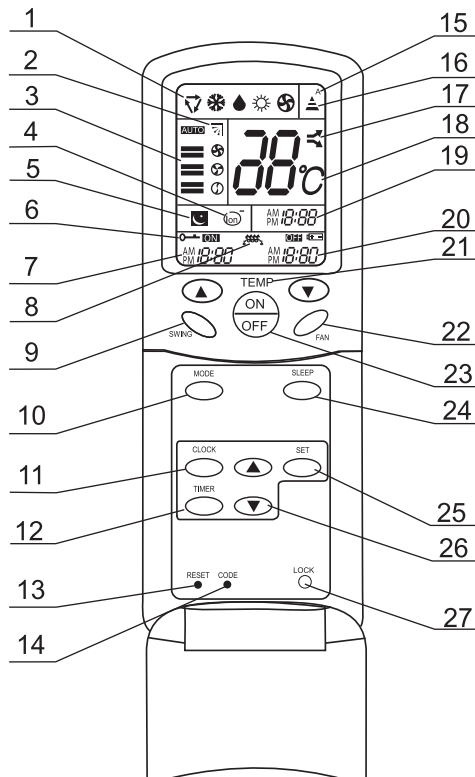

1. Mode display  
AUTO   
COOL   
DRY   
HEAT   
FAN
2. SWING display
3. FAN SPEED display
4. HEALTH display
5. SLEEP display
6. LOCK display
7. TIMER ON display
8. AUXILIARY HEAT display
9. SWING
10. MODE  
Used to select AUTO, COOL and FAN
11. CLOCK  
Used to set correct time
12. TIMER  
Used to select TIMER ON, TIMER OFF
13. RESET  
Used to reset the controller back to normal condition.
14. CODE  
Used to select code A or B with a press, A or B will be displayed on LCD. please select A without special explanation
15. CODE display
16. SIGNAL SENDING display
17. POWER/SOFT display
18. TEMP. display
19. CLOCK display
20. TIMER OFF display
21. TEMP  
Used to select your desired temperature
22. FAN  
Used to select fan speed
23. POWER ON/OFF  
Used for unit start or stop
24. SLEEP  
Used to select sleep mode

25. SET  
Used to confirm timer and clock settings
26. HOUR  
Used to set clock and timer settings
27. LOCK  
Used to lock buttons and LCD display.

NOTE: (1) The following functions and related displays are not available: AUXILIARY HEAT display, POWER/SOFT display, HEALTH display.  
 (2) If the Air conditioner don't have the function of the code, press code B can cause it not available.  
 (3) Cooling only unit do not have functions and displays related with heating.

### Clock set

When unit is started for the first time and after replacing batteries in remote controller, clock should be adjusted as follows:

Press CLOCK button, "AM" or "PM" flashes.

Press  $\Delta$  or  $\nabla$  to set correct time. Each press will increase or decrease 1min. If the button is kept depressed, time will change quickly.

After time setting is confirmed, press SET, "AM" and "PM" stop flashing, while clock starts working.

### Hints

After replacing with new batteries, remote controller will conduct self-check, displaying all information on LCD. Then, it will become normal.

# 13 Center of gravity

HSU-14HR03/R2

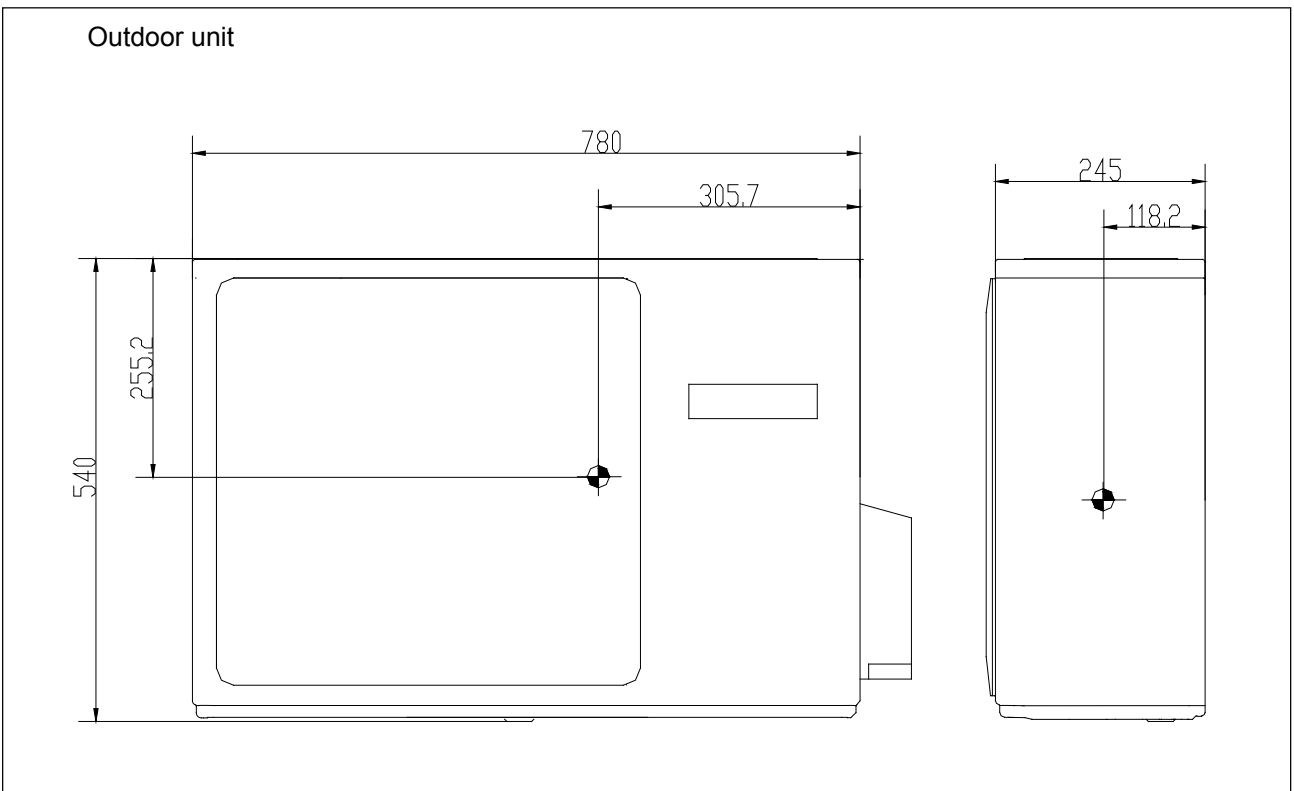
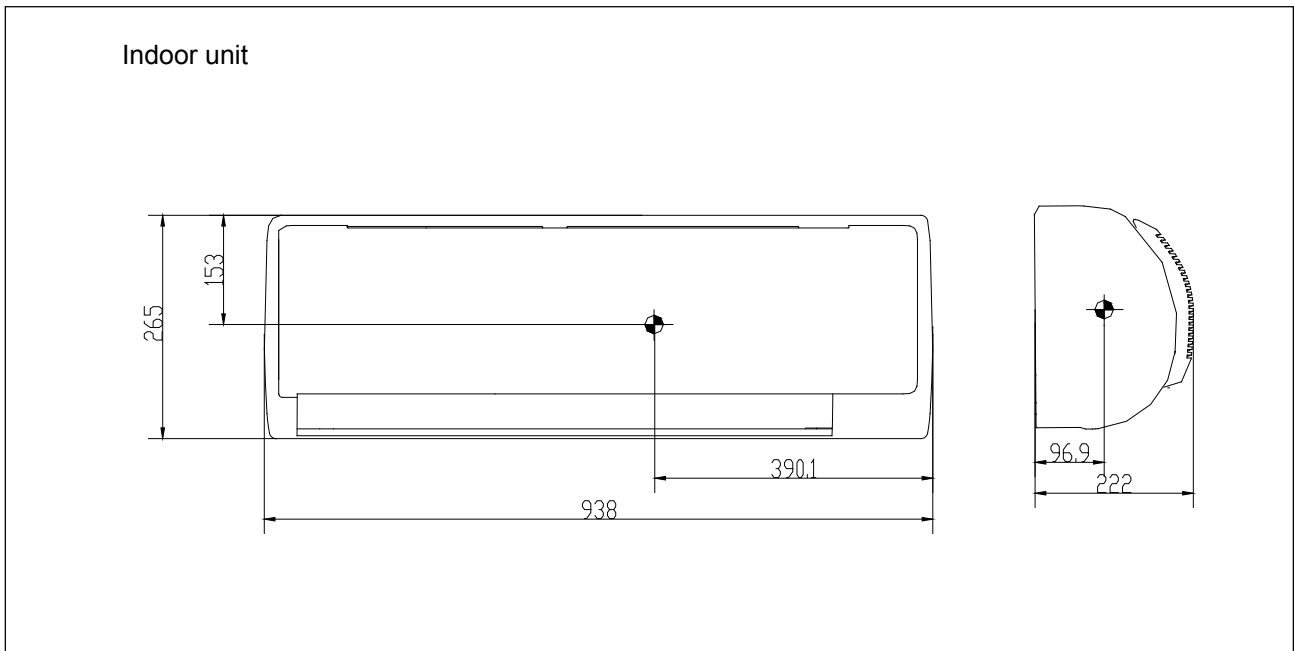

# Center of gravity

HSU-18HR03/R2

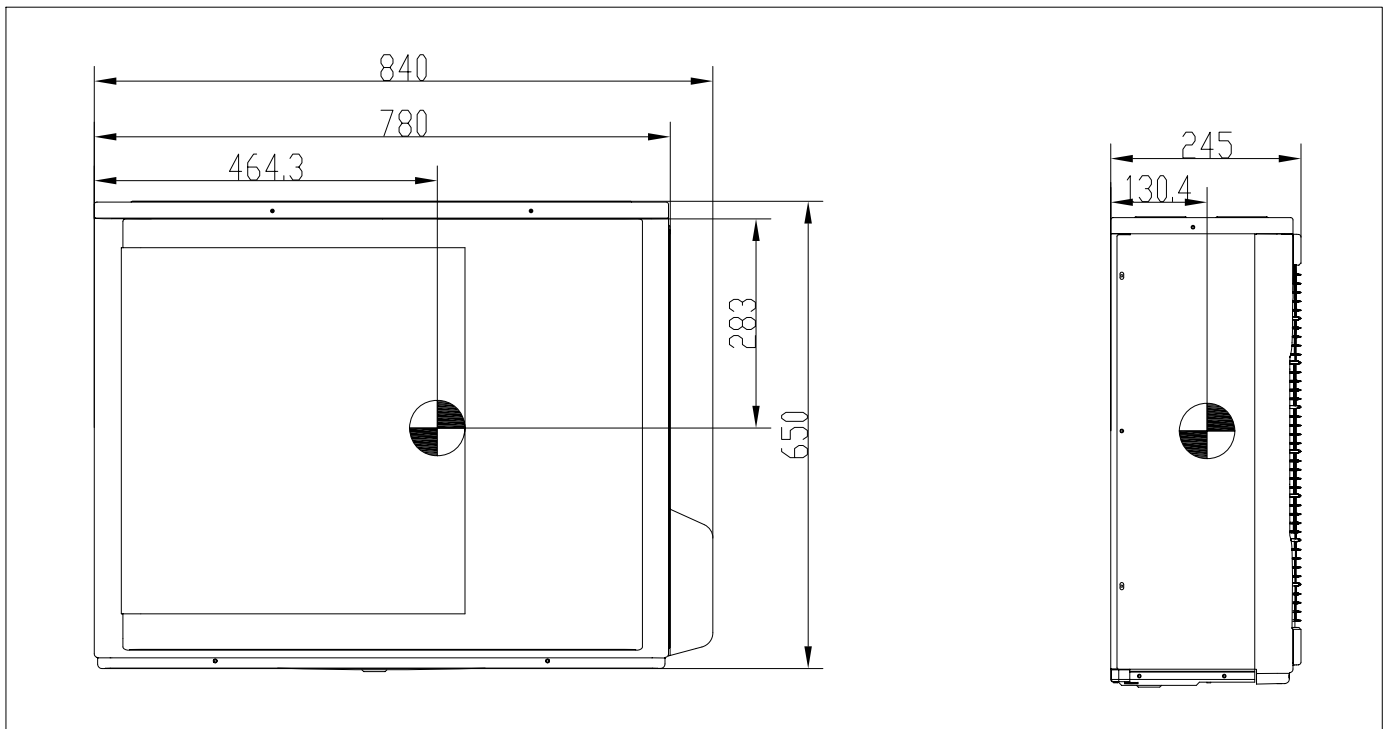
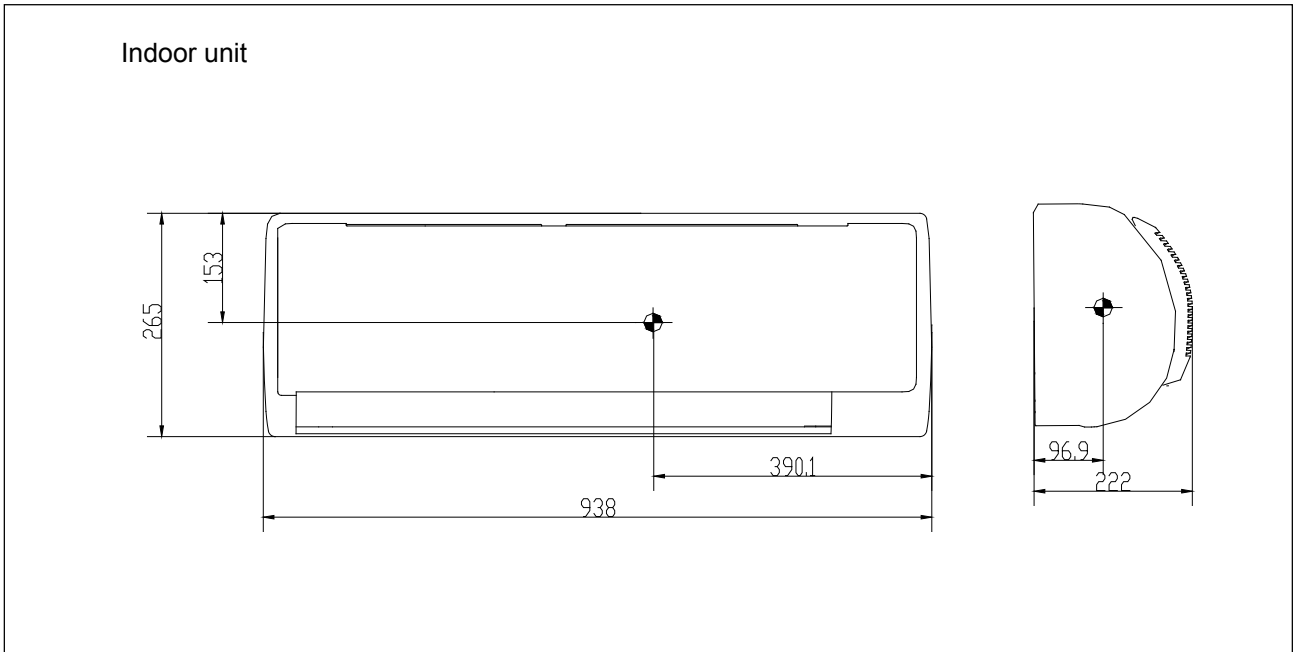

# 14 Installation

## Indoor

- How to attach the indoor unit.  
Hook the claws of the bottom frame to the mounting plate.  
If the claws are difficult to hook ,remove the front panel.
- How to remove the indoor unit.  
Push up the marked area (at the lower part of the front panel ) to release the the claws . If it is difficult to release ,remove the front panel .

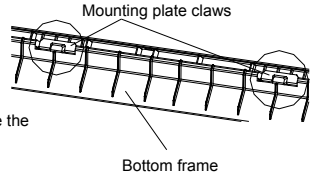

The diagram shows a side view of the mounting plate with several curved claws extending downwards. Below it, the bottom frame of the indoor unit is shown with corresponding slots for the claws to fit into.

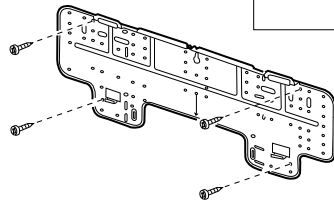

The mounting plate should be installed on a wall which can support the weight of the indoor unit.

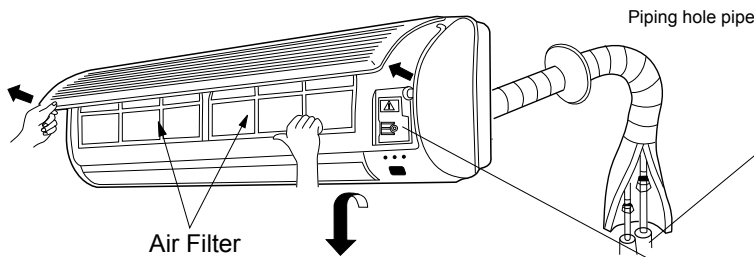

Cut thermal insulation pipe to an appropriate length and wrap it with tape, making sure that no gap is left in the insulation pipe's cut line .

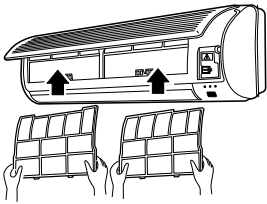

The diagram shows the indoor unit with two air filters being removed. Arrows indicate the filters being pulled upwards and then downwards.

**How to remove the air filter.**

Open the inlet grille by pulling it upward.

Push up the filter's center tab slightly until it is released from the stopper, and remove the filter downward.

**How to Attach the air filter.**

Attach the filter correctly so that the "FRONT" indication is facing to the front.Make sure that the filter is completely fixed behind the stopper.If the right and left filters are not attached correctly, that may cause defects.

Close the inlet grille.

**Service lid**  
The service lid is an open/close type

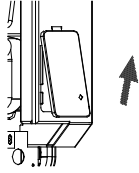

The diagram shows the service lid being opened. An arrow points upwards, indicating the lid is rotated up.

Remove the screws on the service lid.  
Slide the service lid leftward.  
Rotate the service lid upward



### Outdoor unit

Model	35/40 class
Max.allowable length	Cooling only: 20m Heat pump: 25m
Max.allowable height	15m
Additional refrigerant required for refrigerant pipe exceeding 5m in length	20g/m
Gas pipe	O.D. 12.7
Liquid pipe	O.D. 6.35

\*Be sure to add the proper amount of additional refrigerant. Failure to do so may result inreduced performance.

Arrangement of piping directions

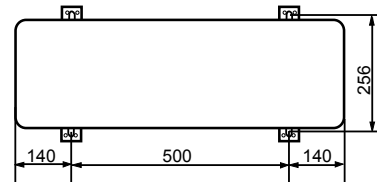
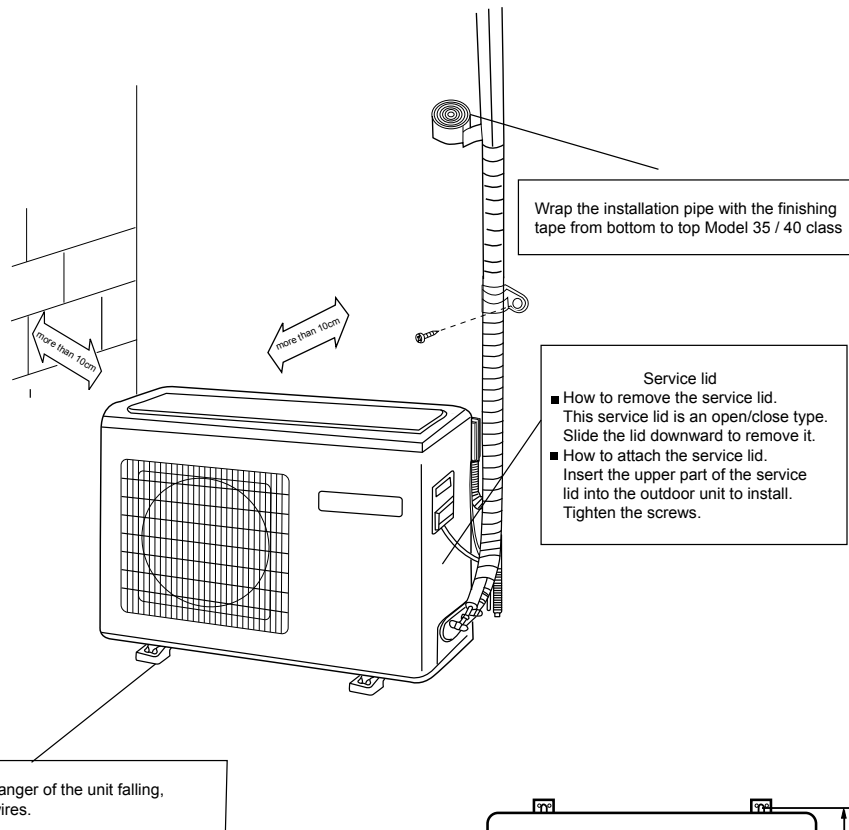
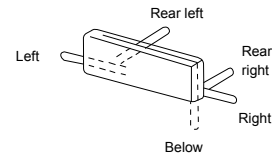

- Fix the unit to concrete or block with bolts( $\phi$ 10mm) and nuts firmly and horizontally.
- When fitting the unit to wall surface, roof or rooftop, fix a supporter surely with nails or wires in consideration of earthquake and strong wind. The distance between the indoor unit and the floor should be more than 2m
- If vibration may affect the house, fix the unit by attaching a vibration-proof mat.

# Sincere Forever



Haier Group

---

Haier Industrial Park, No.1, Haier Road

266101, Qingdao, China

E-mail: [hractech@haier.com](mailto:hractech@haier.com)

Tel: +86 532 87636957

[Http://www.haier.com](http://www.haier.com)

Edited by: Ma Sai

Signed by: Zhang Lizhi

Approved by: Zhu Zhenxue