



82CXX

CMOS IC

VOLTAGE DETECTORS

DESCRIPTION

The UTC **82CXX** series are good performance 3-terminals voltage detectors and manufactured by CMOS technologies with highly accurate, low power consumption. The detection voltage is extremely accurate with minimal temperature drift.

FEATURES

- *High-accuracy detection voltage : $\pm 2\%$
- *Detect voltage range : 0.9V to 6.2V in 0.1V increments
- *Detect voltage temperature characteristics: TYP. $\pm 100\text{ppm}/^\circ\text{C}$.
- *Wide operating voltage range : 0.7V to 10.0V
- *Low current consumption : TYP 0.7 μA (at $V_{\text{IN}}=1.5\text{V}$)

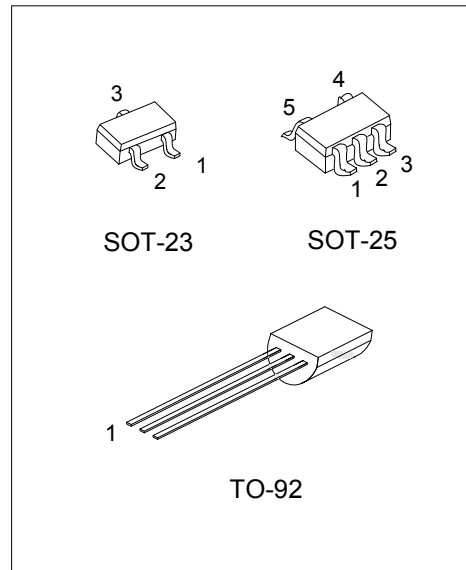

ORDERING INFORMATION

Ordering Number		Package	Pin Assignment					Packing
Lead Free	Halogen-Free		1	2	3	4	5	
82CxxL-AE3-5-R	82CxxG-AE3-5-R	SOT-23	G	O	I	-	-	Tape Reel
82CxxL-AF5-R	82CxxG-AF5-R	SOT-25	O	I	G	N	N	Tape Reel
82CxxL-T92-D-B	82CxxG-T92-D-B	TO-92	I	G	O	-	-	Tape Box
82CxxL-T92-D-K	82CxxG-T92-D-K	TO-92	I	G	O	-	-	Bulk

Note: 1. Pin assignment: I: V_{IN} O: V_{OUT} G: V_{SS} N: NC
 2.xx: Output Voltage, refer to Marking Information

<p>82CxxL-AE3-5-R</p> <p>(1) Packing Type (2) Pin Assignment (3) Package Type (4) Lead Plating (5) Output Voltage Code</p>	<p>(1) B: Tape Box, K: Bulk, R: Tape Reel (2) refer to Pin Assignment (3) AE3: SOT-23, AF5: SOT-25, T92: TO-92 (4) G: Halogen Free, L: Lead Free (5) xx: refer to Marking Information</p>
--	---

MARKING INFORMATION

PACKAGE	VOLTAGE CODE		MARKING		
SOT-23	09:0.9V	35:3.5V	<p>Voltage Code ← LXX → L: Lead Free G: Halogen Free</p>		
	10:1.0V	36:3.6V			
	11:1.1V	37:3.7V			
	12:1.2V	38:3.8V			
	13:1.3V	39:3.9V			
	14:1.4V	40:4.0V			
	15:1.5V	41:4.1V			
	16:1.6V	42:4.2V			
	17:1.7V	43:4.3V			
	SOT-25	18:1.8V		44:4.4V	<p>Voltage Code ← LXX → L: Lead Free G: Halogen Free</p>
		19:1.9V		45:4.5V	
		20:2.0V		46:4.6V	
		21:2.1V		47:4.7V	
		22:2.2V		48:4.8V	
		23:2.3V		49:4.9V	
		24:2.4V		50:5.0V	
		25:2.5V		51:5.1V	
26:2.6V		52:5.2V			
TO-92		27:2.7V	53:5.3V	<p>UTC → L: Lead Free G: Halogen Free 82CXX → Voltage Code C:CMOS → C:CMOS Pin Code ← → Date Code</p>	
	28:2.8V	54:5.4V			
	29:2.9V	55:5.5V			
	30:3.0V	56:5.6V			
	31:3.1V	57:5.7V			
	32:3.2V	58:5.8V			
	33:3.3V	59:5.9V			
	34:3.4V	60:6.0V			
		62:6.2V			

■ MARKING CODE FOR SOT-23/SOT-25

PART NUMBER	DETECT VOLATGE		MARKING CODE	PART NUMBER	DETECT VOLATGE		MARKING CODE
	VOLTAGE	CODE			VOLTAGE	CODE	
82C09	0.9V	9	L09	82C36	3.6V	36	L36
82C10	1.0V	10	L10	82C37	3.7V	37	L37
82C11	1.1V	11	L11	82C38	3.8V	38	L38
82C12	1.2V	12	L12	82C39	3.9V	39	L39
82C13	1.3V	13	L13	82C40	4.0V	40	L40
82C14	1.4V	14	L14	82C41	4.1V	41	L41
82C15	1.5V	15	L15	82C42	4.2V	42	L42
82C16	1.6V	16	L16	82C43	4.3V	43	L43
82C17	1.7V	17	L17	82C44	4.4V	44	L44
82C18	1.8V	18	L18	82C45	4.5V	45	L45
82C19	1.9V	19	L19	82C46	4.6V	46	L46
82C20	2.0V	20	L20	82C47	4.7V	47	L47
82C21	2.1V	21	L21	82C48	4.8V	48	L48
82C22	2.2V	22	L22	82C49	4.9V	49	L49
82C23	2.3V	23	L23	82C50	5.0V	50	L50
82C24	2.4V	24	L24	82C51	5.1V	51	L51
82C25	2.5V	25	L25	82C52	5.2V	52	L52
82C26	2.6V	26	L26	82C53	5.3V	53	L53
82C27	2.7V	27	L27	82C54	5.4V	54	L54
82C28	2.8V	28	L28	82C55	5.5V	55	L55
82C29	2.9V	29	L29	82C56	5.6V	56	L56
82C30	3.0V	30	L30	82C57	5.7V	57	L57
82C31	3.1V	31	L31	82C58	5.8V	58	L58
82C32	3.2V	32	L32	82C59	5.9V	59	L59
82C33	3.3V	33	L33	82C60	6.0V	60	L60
82C34	3.4V	34	L34	82C62	6.2V	62	L62
82C35	3.5V	35	L35				

■ BLOCK DIAGRAM

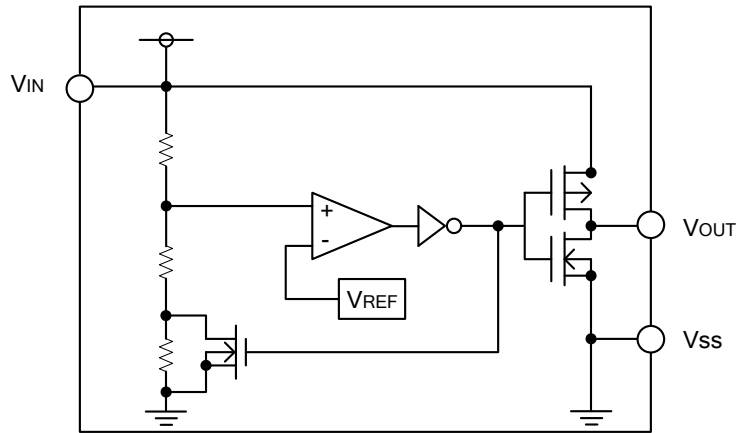

■ TYPICAL APPLICATION CIRCUITS

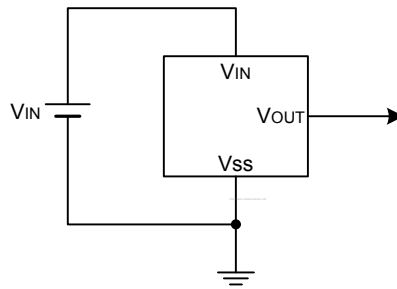

■ ABSOLUTE MAXIMUM RATINGS (Ta=25°C, unless otherwise specified.)

PARAMETER		SYMBOL	RATINGS	UNIT
Input Voltage		V _{IN}	12	V
Output Current		I _{OUT}	50	mA
Output Voltage		V _{OUT}	V _{SS} -0.3 ~ V _{IN} +0.3	V
Power Dissipation	SOT-23/SOT-25	P _D	150	mW
	TO-92		300	mW
Operating Temperature		T _{OPR}	-40 ~ +85	°C
Storage Temperature		T _{STG}	-40 ~ +150	°C

Note: Absolute maximum ratings are those values beyond which the device could be permanently damaged. Absolute maximum ratings are stress ratings only and functional device operation is not implied.

■ ELECTRICAL CHARACTERISTICS (Ta=25°C, unless otherwise specified.)

PARAMETER	SYMBOL	CIRCUIT	TEST CONDITONS	MIN	TYP	MAX	UNIT
Detect Voltage (Note 2)	V _{DF}	1		V _{DF} ×0.98	V _{DF}	V _{DF} ×1.02	V
Hysteresis Range	V _{HYS}	1		V _{DF} ×0.02	V _{DF} ×0.05	V _{DF} ×0.08	V
Supply Current	I _{SS}	2	V _{IN} = 1.5V		0.7	2.3	μA
			V _{IN} = 2.0V		0.8	2.7	μA
			V _{IN} = 3.0V		0.9	3.0	μA
			V _{IN} = 4.0V		1.0	3.2	μA
			V _{IN} = 5.0V		1.1	3.6	μA
Operating Voltage	V _{IN}	1	V _{DF(T)} =0.9V ~ 1.5V	0.7		6	V
			V _{DF(T)} =1.6V ~ 6.2V	0.7		10	V
Output Current (V _{DF} ≤1.5V)	I _{OUT}	3	N-ch, V _{DS} =0.5V	V _{IN} =0.7V	0.1	0.8	mA
				V _{IN} =1.0V	0.85	2.7	mA
		4	P-ch, V _{DS} =2.1V, V _{IN} =6.0V		-7.5	-1.5	mA
Output Current (V _{DF} ≥1.6V)	I _{OUT}	3	N-ch, V _{DS} =0.5V	V _{IN} =1.0V	1.0	2.2	mA
				V _{IN} =2.0V	3.0	7.7	mA
				V _{IN} =3.0V	5.0	10.1	mA
				V _{IN} =4.0V	6.0	11.5	mA
				V _{IN} =5.0V	7.0	13.0	mA
		4	P-ch, V _{DS} =2.1V, V _{IN} =8.0V		-10.0	-2	mA
Temperature Characteristics	$\frac{\Delta V_{DF}}{\Delta T_{OPR} \times V_{DF}}$		-40°C ≤ T _{OPR} ≤ 85°C		±100		ppm/°C
Transient Delay Time	t _{DLY}	5				0.2	ms

Note: 1. Detect voltage of ±1% tolerance is also available per customer's request.

2. V_{DF(T)}: Established Detect Voltage Value

■ TEST CIRCUITS

Circuit 1

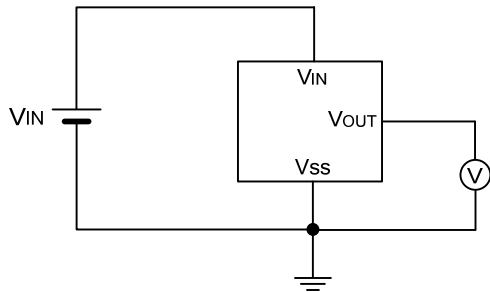

Circuit 2

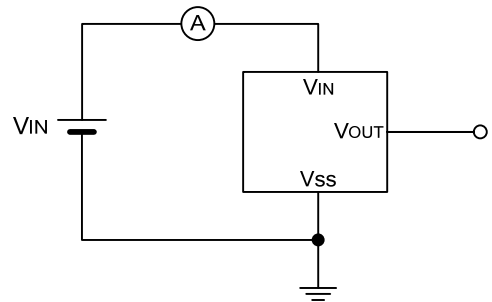

Circuit 3

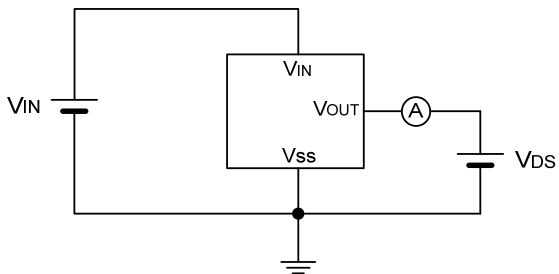

Circuit 4

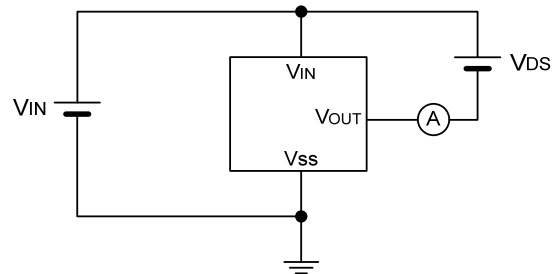

Circuit 5

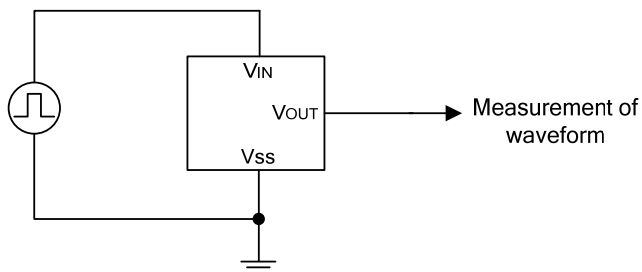

■ TIMING CHART FUNCTIONAL DESCRIPTION

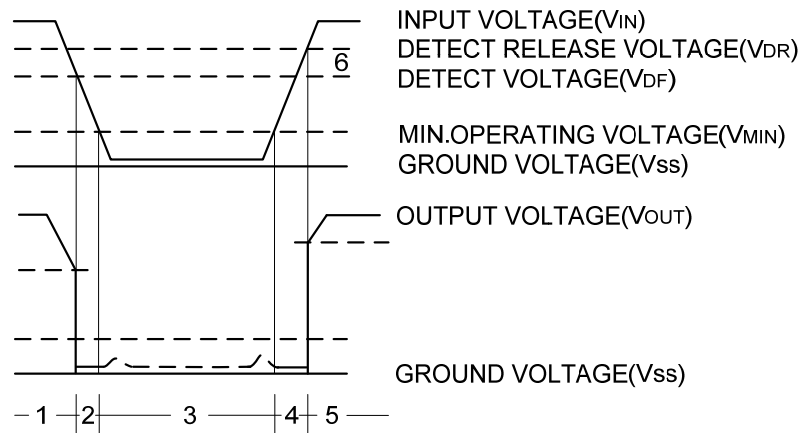

1. When input voltage (V_{IN}) rises above detect voltage (V_{DF}), output voltage (V_{OUT}) will be equal to V_{IN} .
2. When input voltage (V_{IN}) falls below detect voltage (V_{DF}), output voltage (V_{OUT}) will be equal to the ground voltage (V_{SS}) level.
3. When input voltage (V_{IN}) falls to a level below that of the minimum operating voltage (V_{MIN}), output will become unstable. In this condition, V_{IN} will equal the pulled-up output (should output be pulled-up.)
4. When input voltage (V_{IN}) rises above the ground voltage (V_{SS}) level, output will be unstable at levels below the minimum operating voltage (V_{MIN}). Between the V_{MIN} and detect release voltage (V_{DR}) levels, the ground voltage (V_{SS}) level will be maintained.
5. When input voltage (V_{IN}) rises above detect release voltage (V_{DR}), output voltage (V_{OUT}) will be equal to V_{IN} .
6. The difference between V_{DR} and V_{DF} represents the hysteresis range.

■ TYPICAL PERFORMANCE CHARACTERISTICS

(1) P-CHANNEL DRIVER OUTPUT CURRENT vs. INPUT VOLTAGE

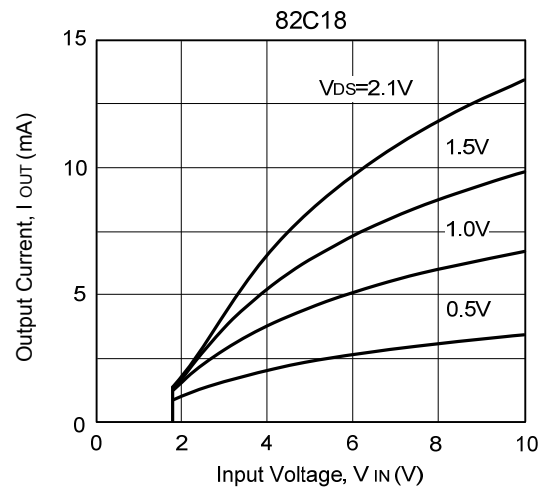
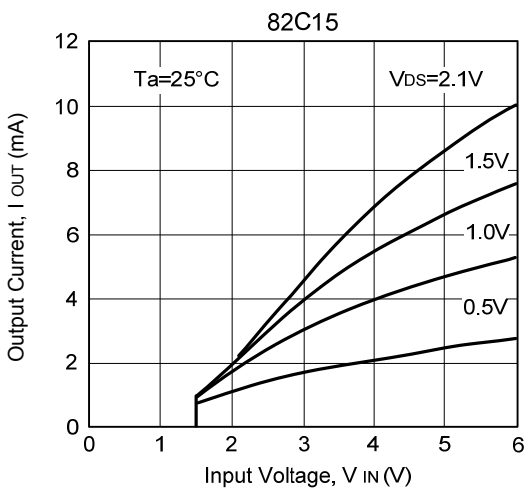
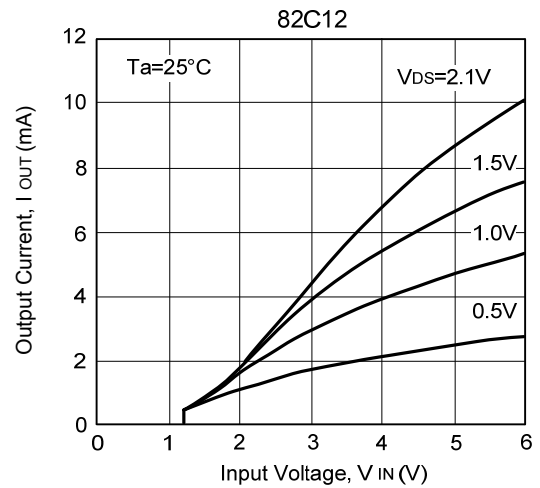
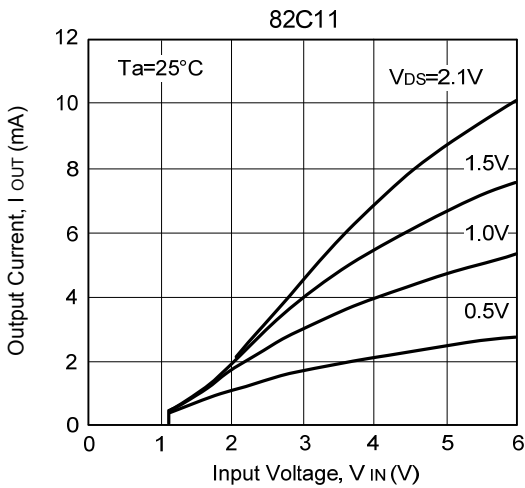
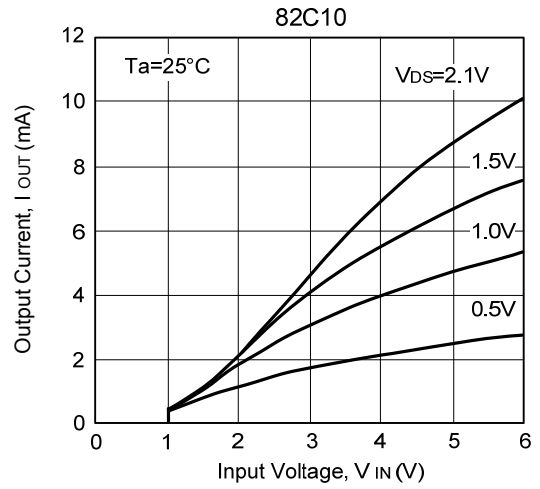
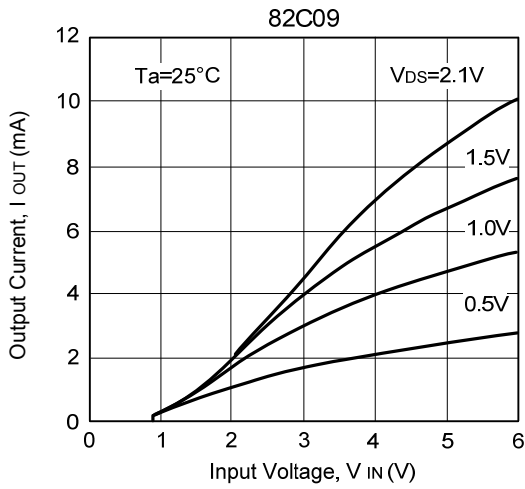

■ TYPICAL PERFORMANCE CHARACTERISTICS (Cont.)

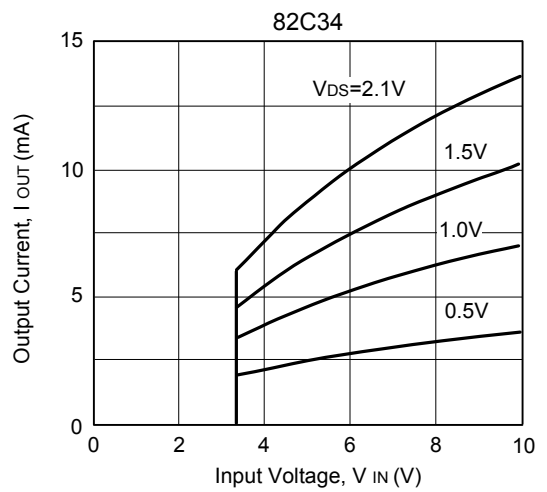
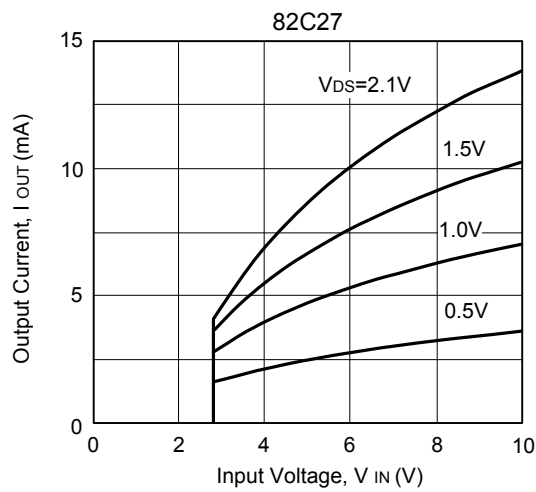
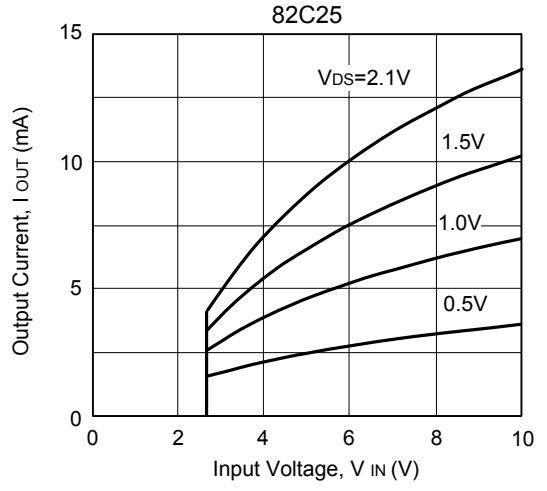
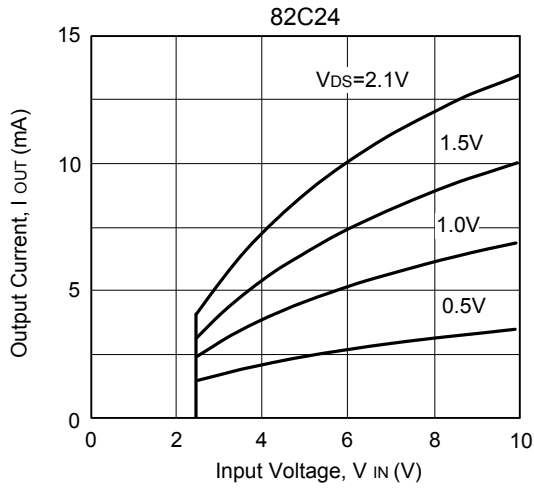
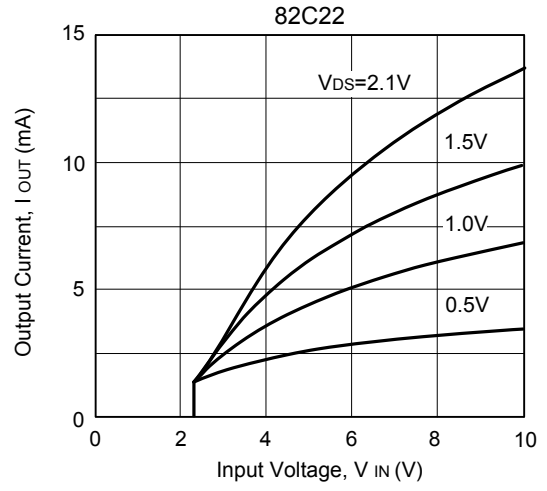
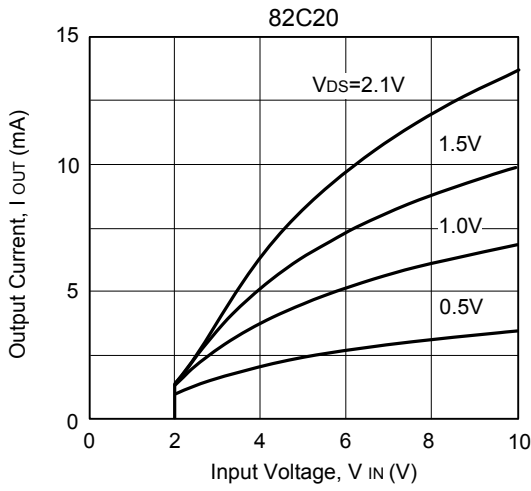

■ TYPICAL PERFORMANCE CHARACTERISTICS (Cont.)

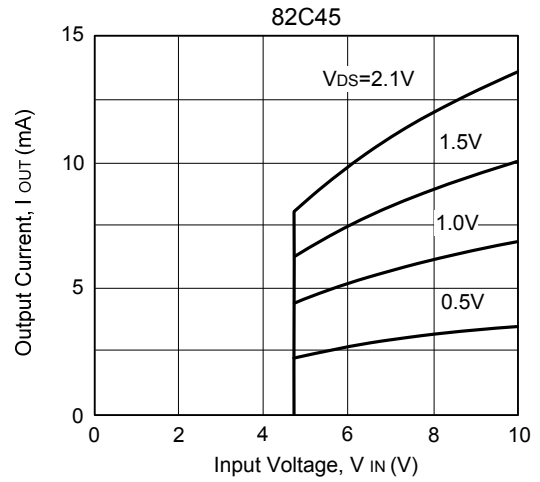
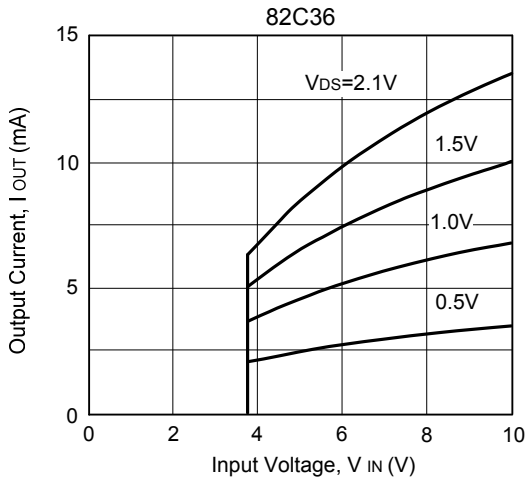

(2) DETECT, RELEASE VOLTAGE vs. AMBIENT TEMPERATURE

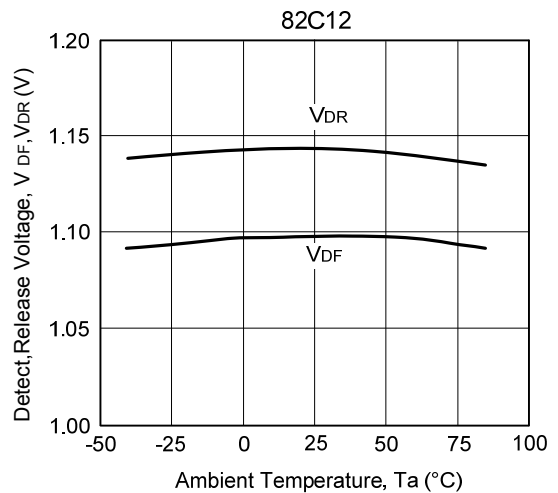
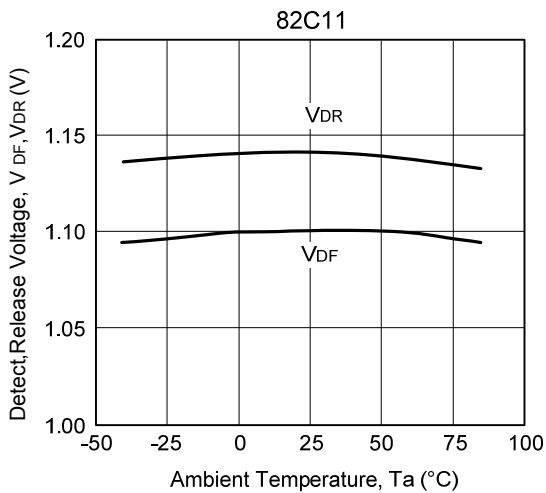
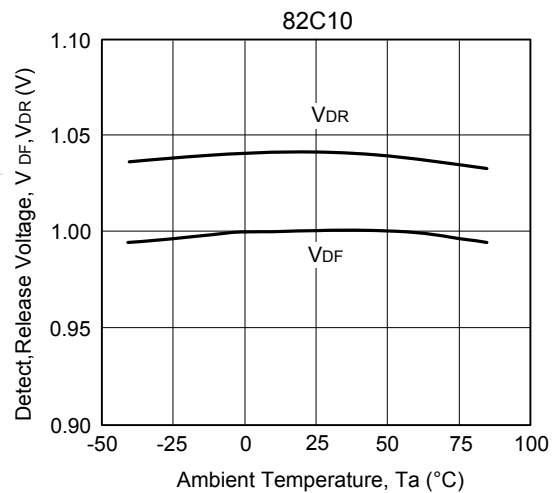
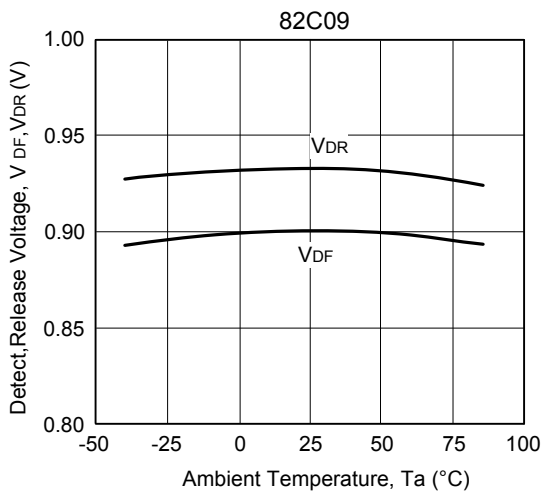

■ TYPICAL PERFORMANCE CHARACTERISTICS (Cont.)

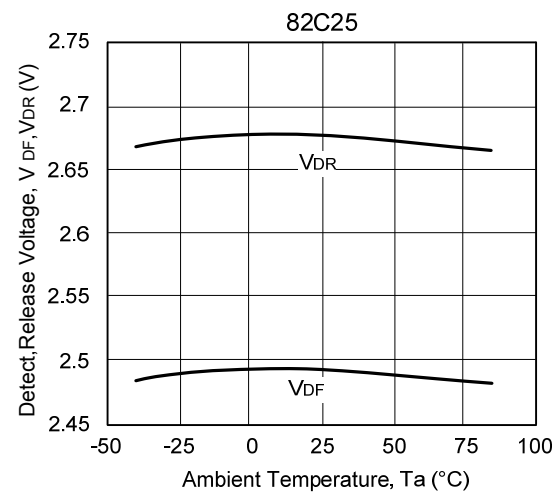
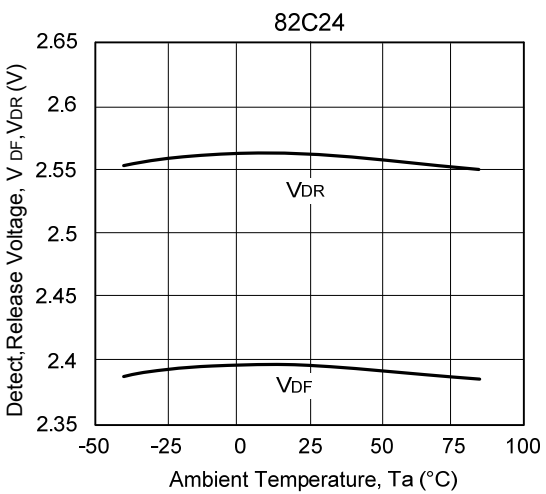
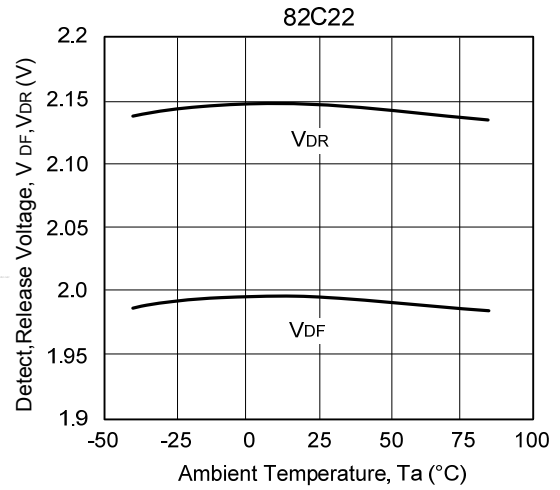
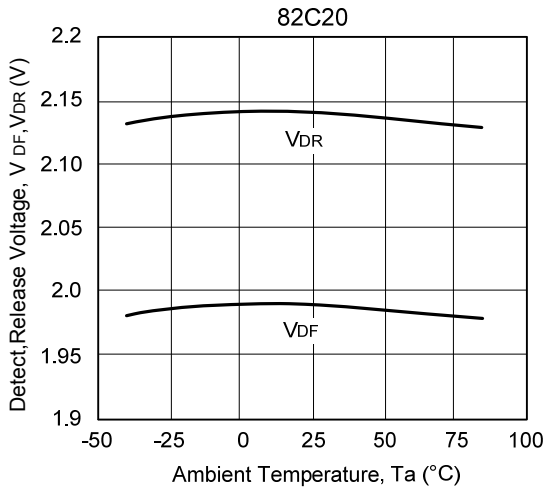
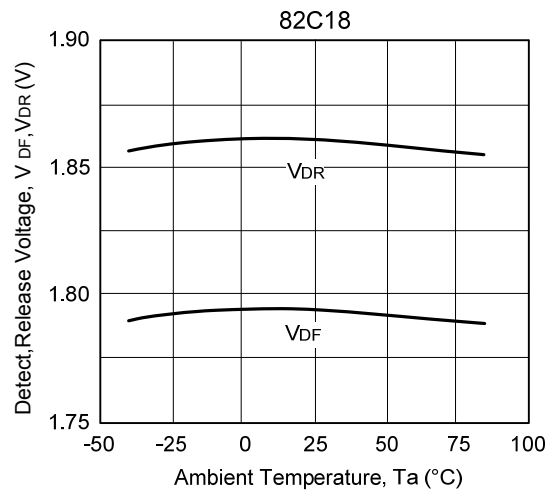
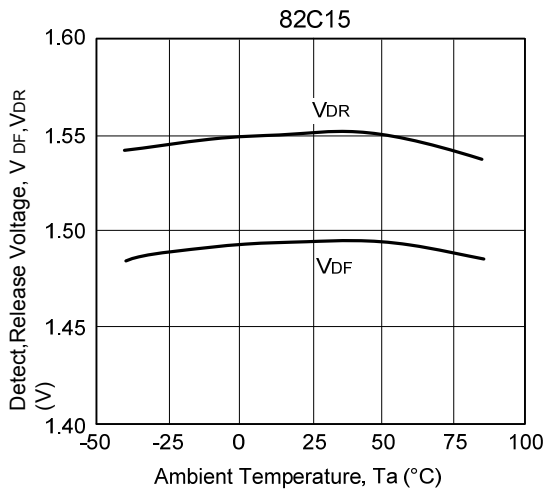

■ TYPICAL PERFORMANCE CHARACTERICS (Cont.)

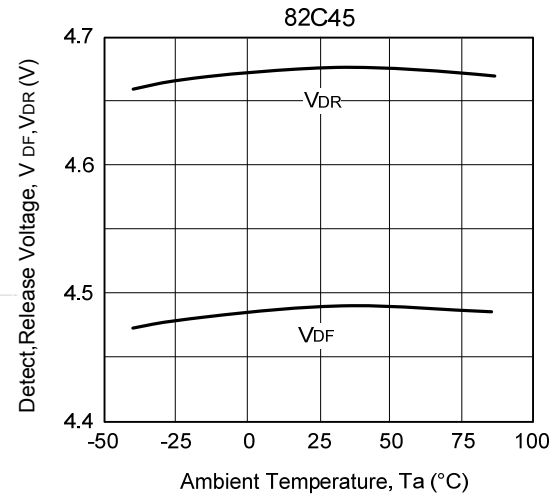
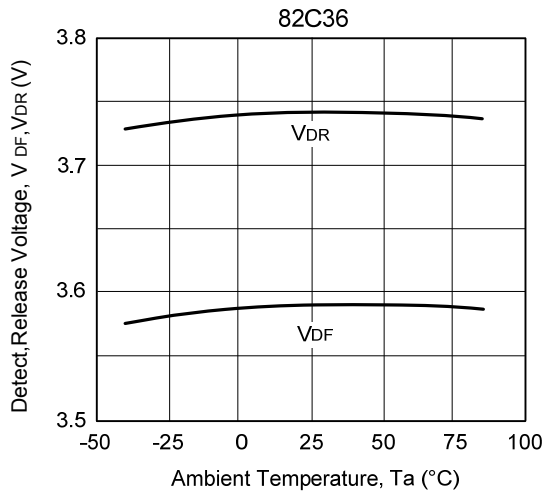
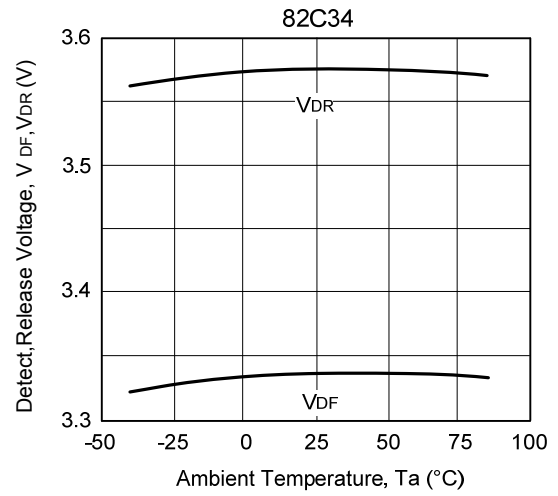
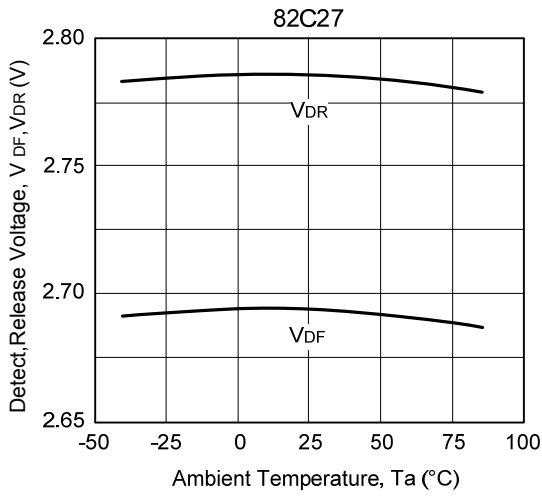

(3) SUPPLY CURRENT vs. INPUT VOLTAGE

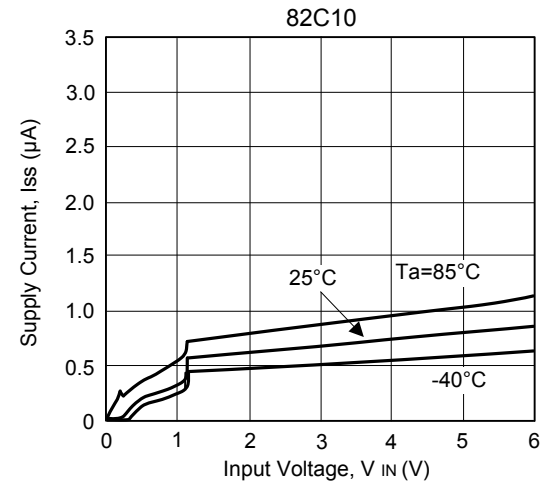
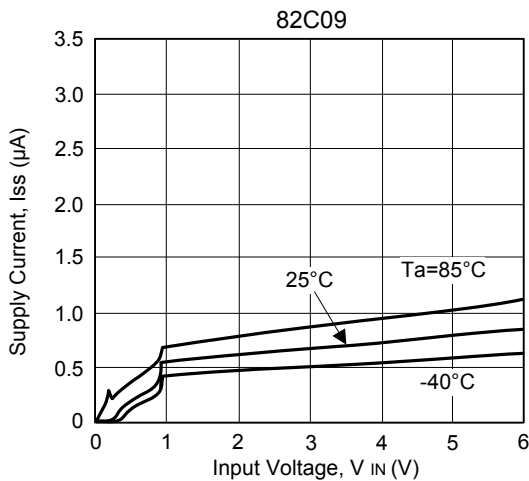

■ TYPICAL PERFORMANCE CHARACTERISTICS (Cont.)

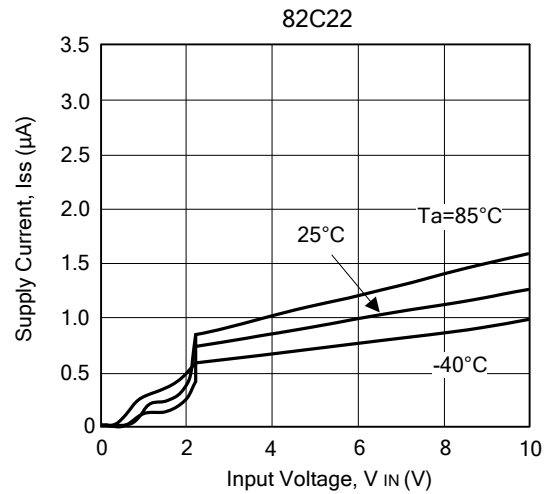
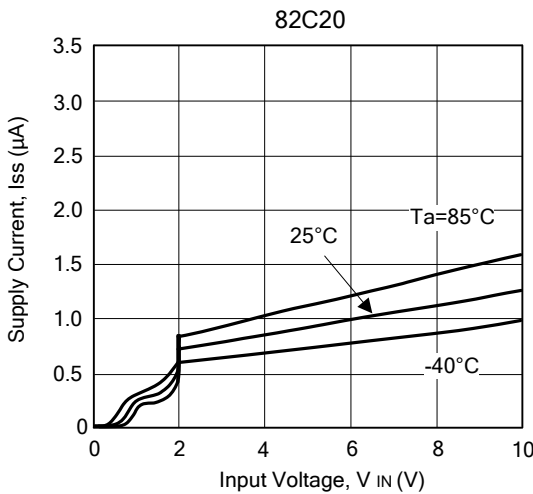
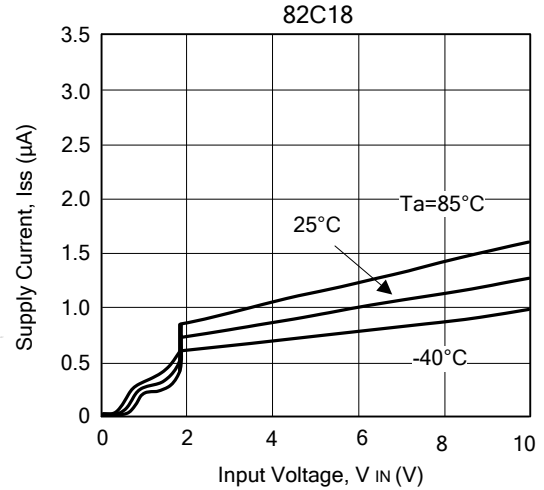
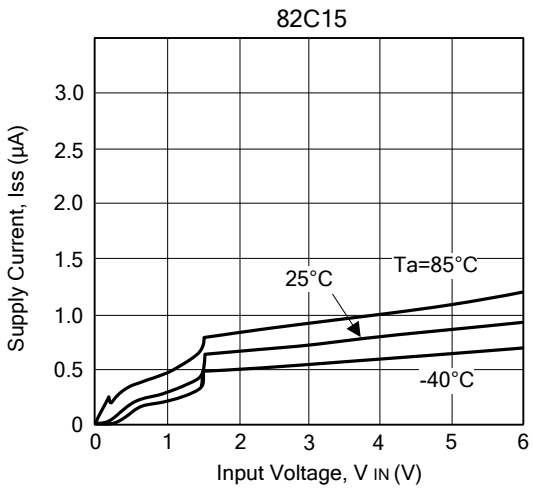
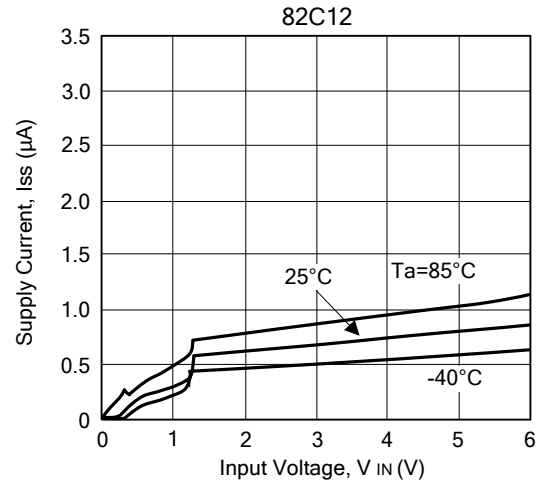
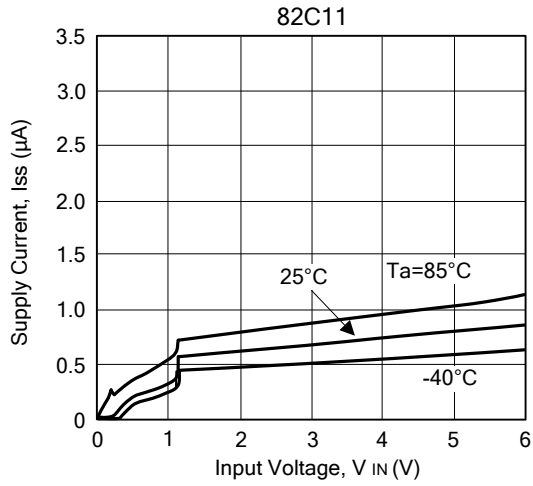

■ TYPICAL PERFORMANCE CHARACTERISTICS (Cont.)

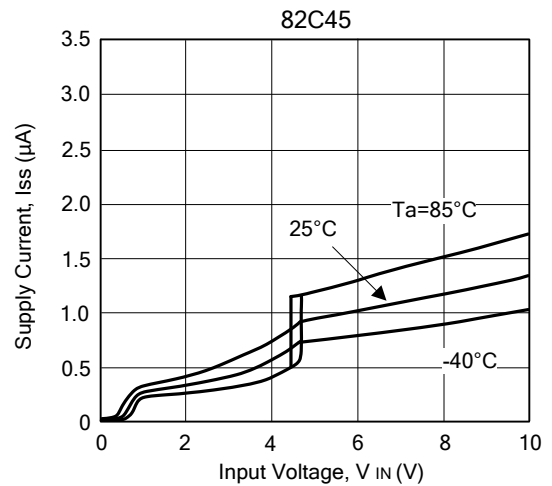
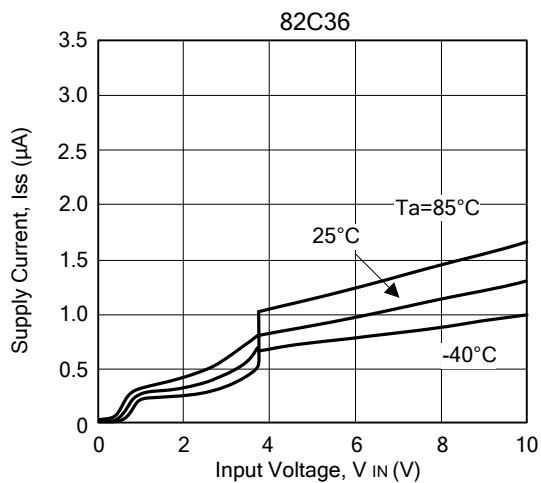
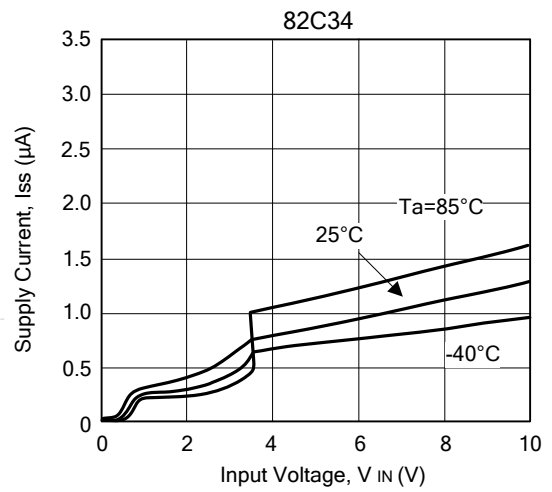
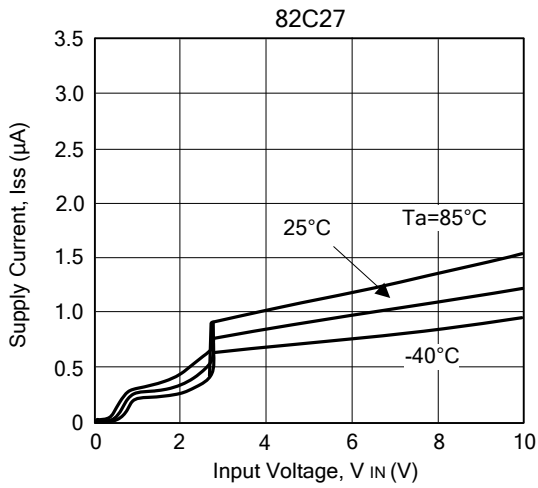
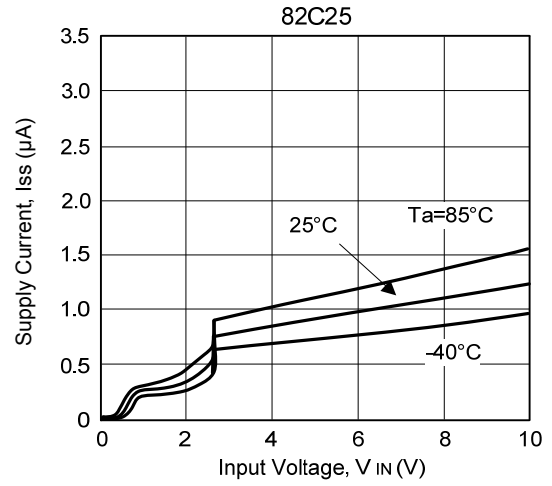
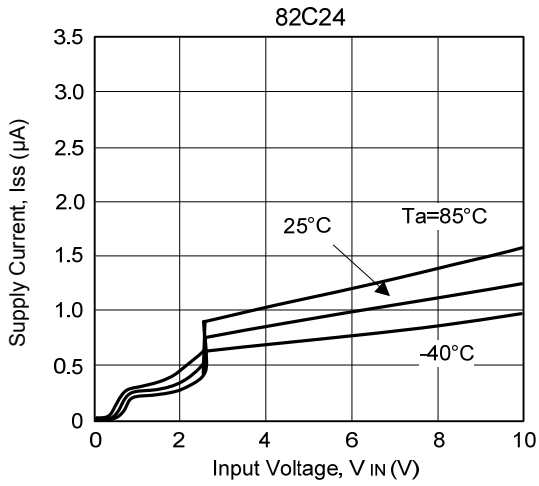

■ TYPICAL PERFORMANCE CHARACTERICS (Cont.)

(4) N-CHANNEL DRIVER OUTPUT CURRENT vs. INPUT VOLTAGE

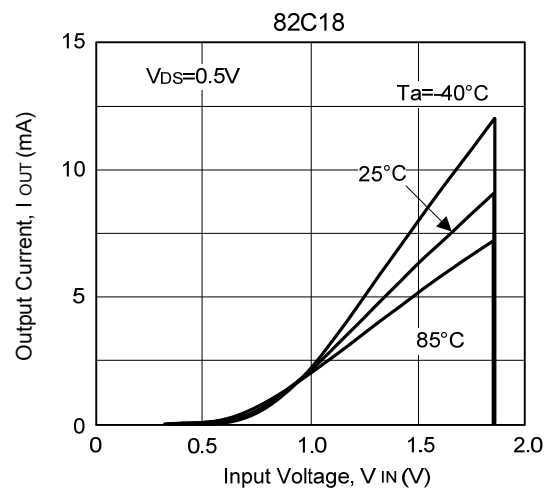
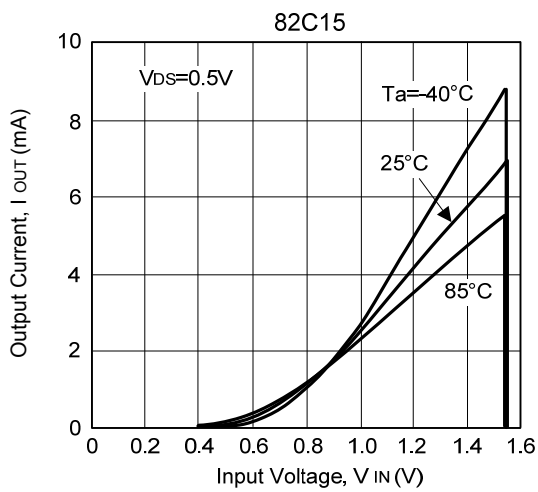
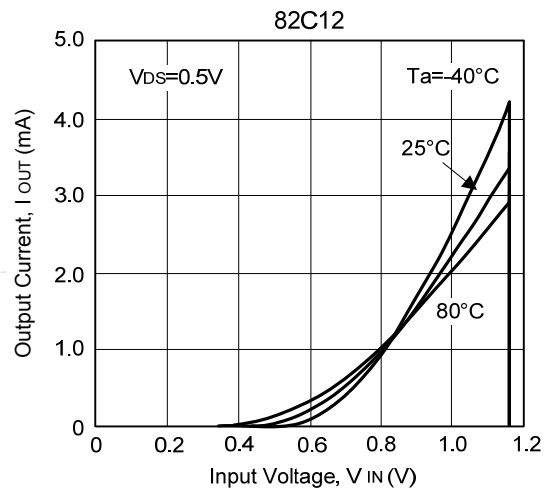
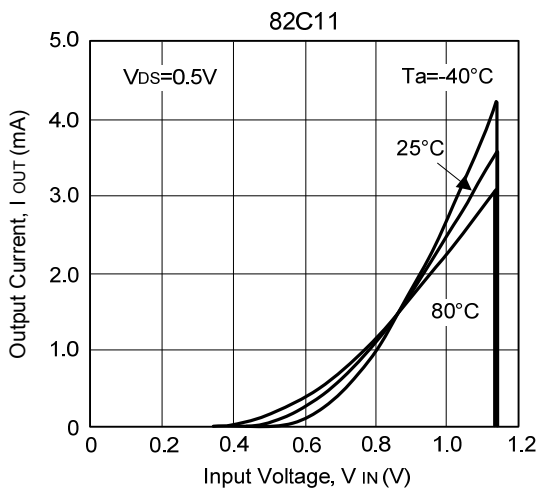
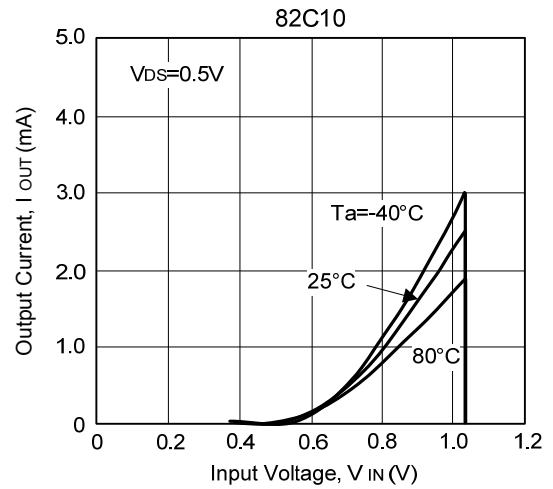
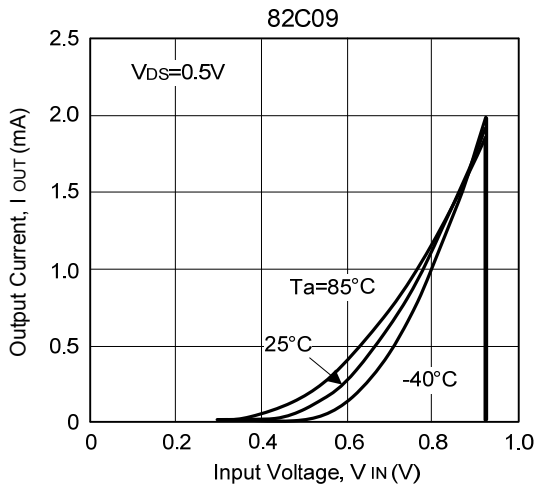

■ TYPICAL PERFORMANCE CHARACTERISTICS (Cont.)

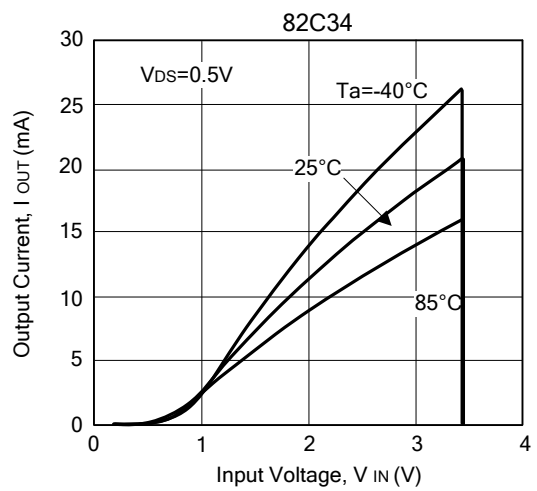
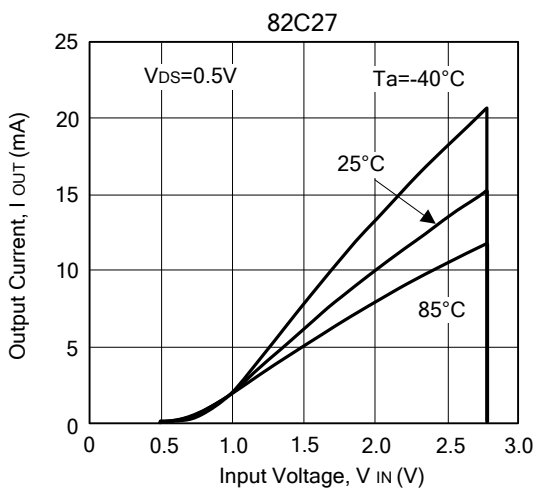
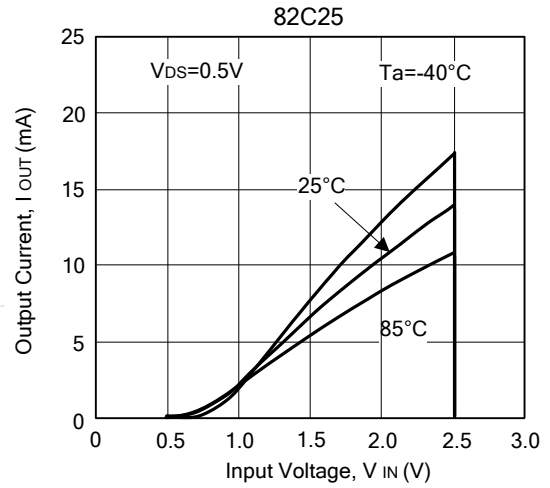
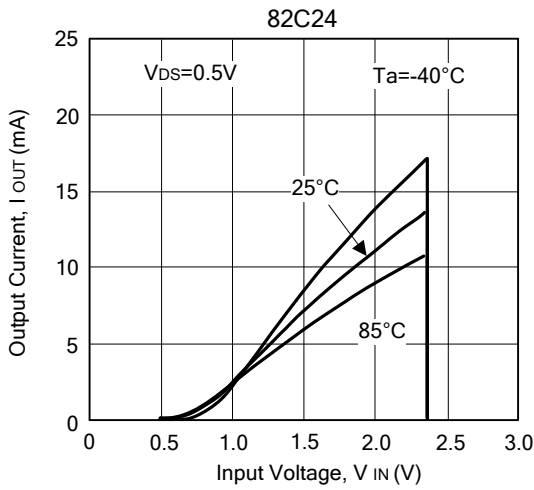
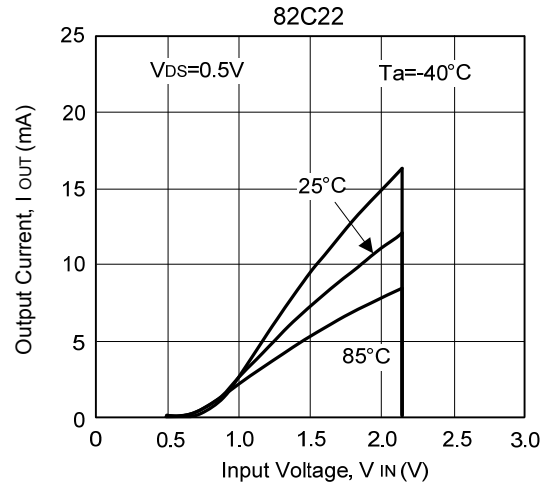
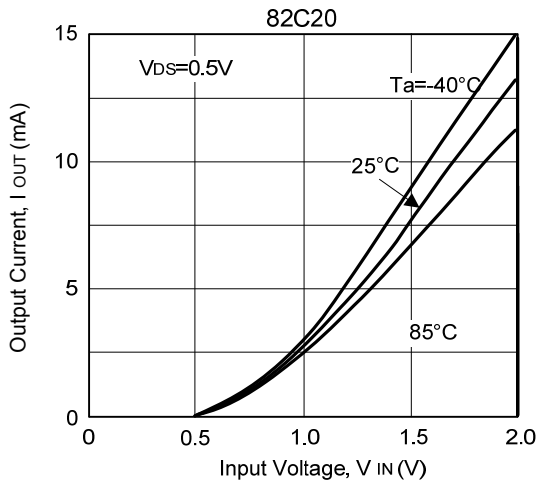

■ TYPICAL PERFORMANCE CHARACTERISTICS (Cont.)

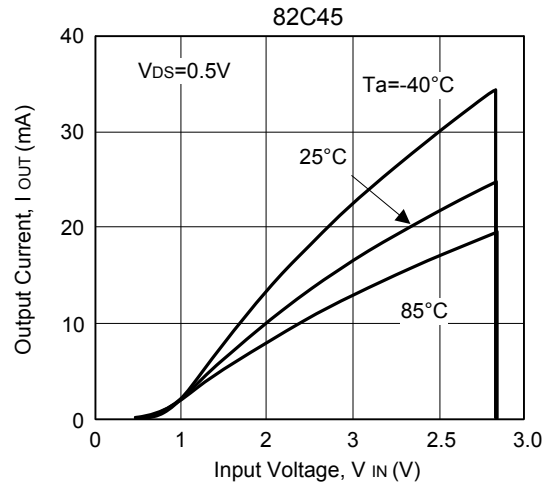
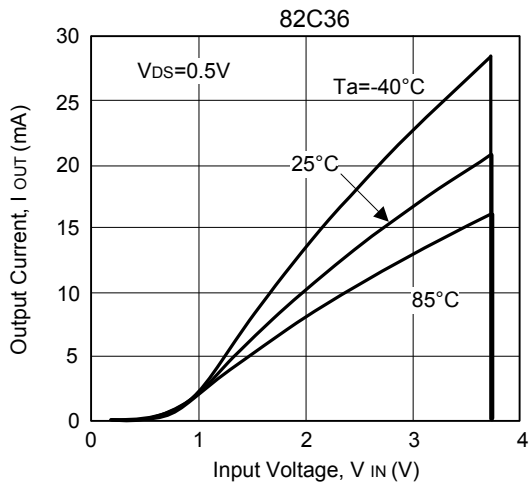

(5) N-CHANNEL DRIVER OUTPUT CURRENT vs. V_{DS}

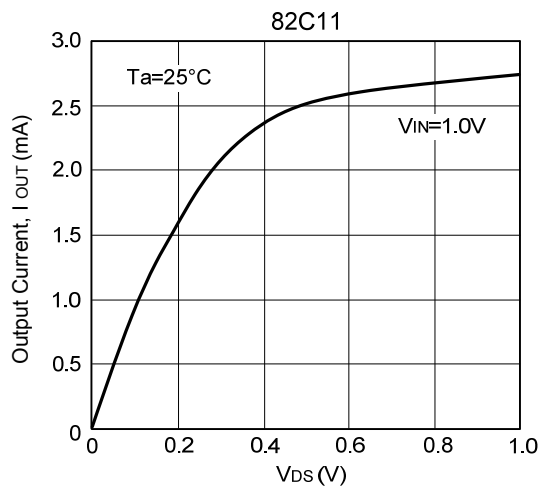
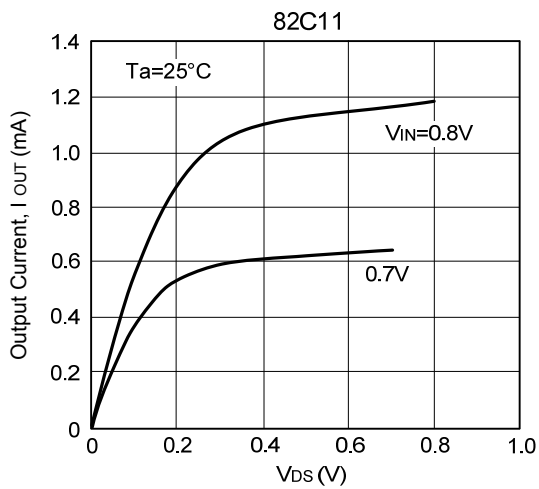
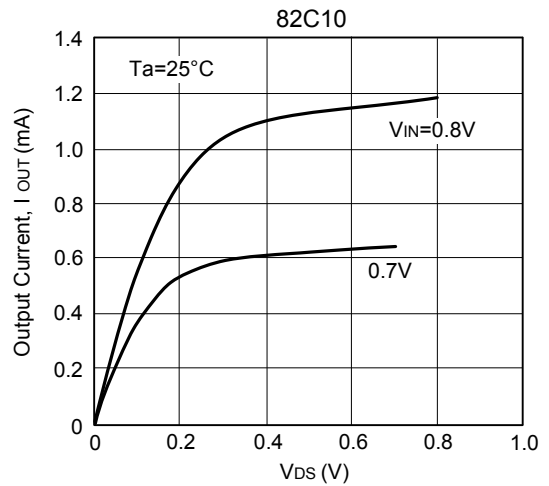
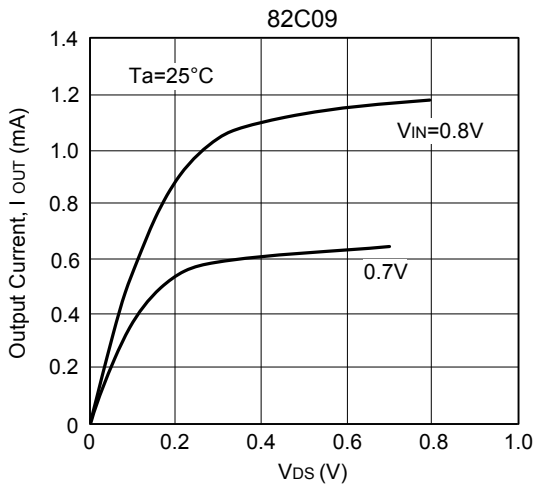

■ TYPICAL PERFORMANCE CHARACTERISTICS (Cont.)

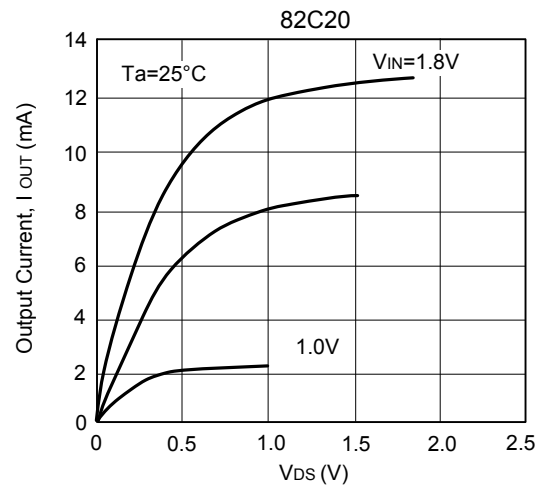
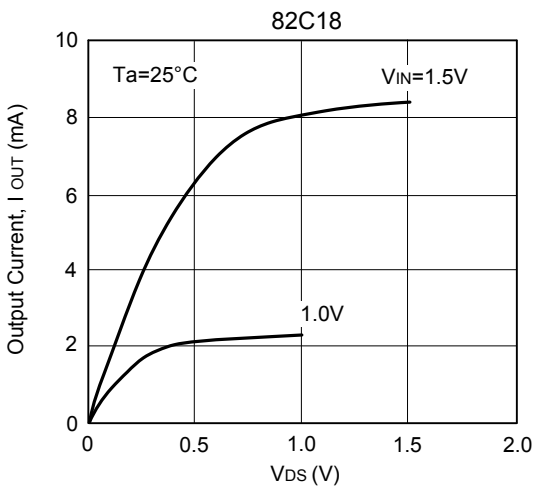
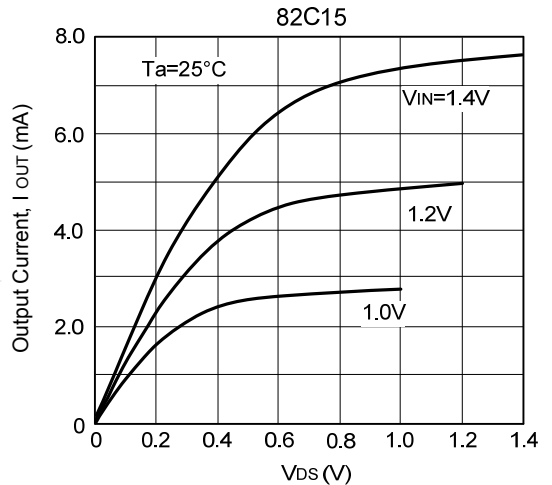
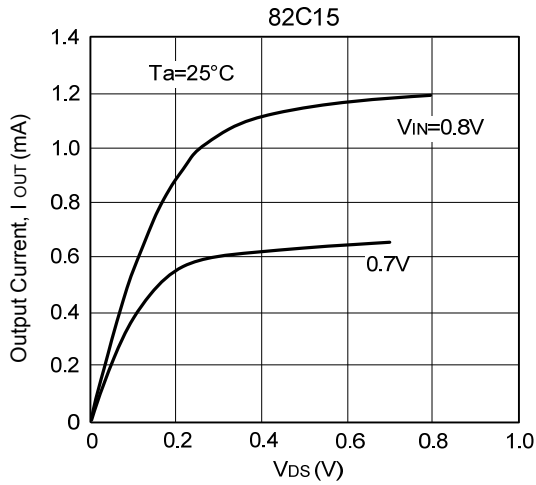
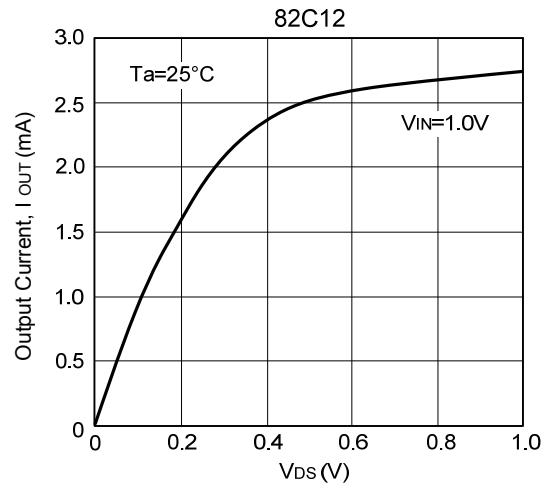
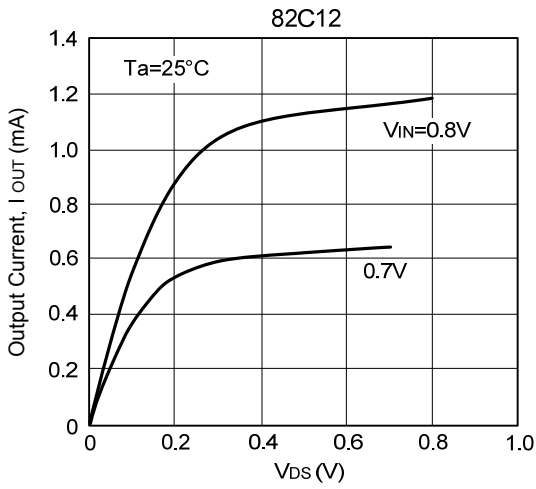

■ TYPICAL PERFORMANCE CHARACTERISTICS (Cont.)

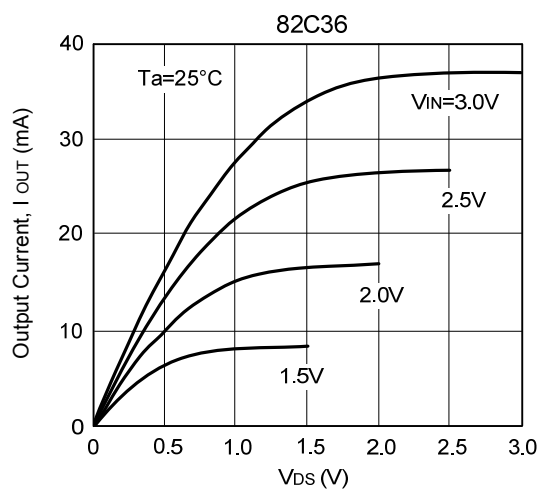
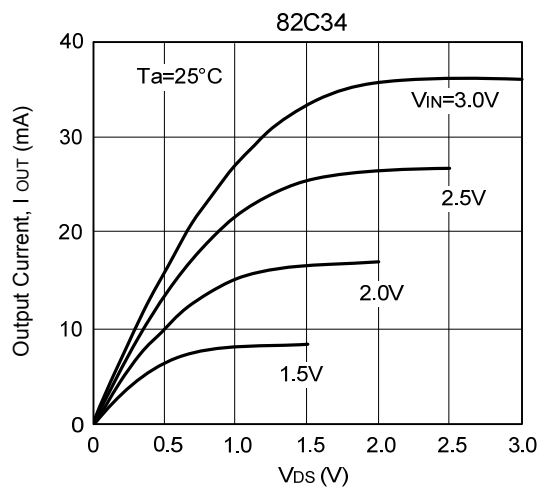
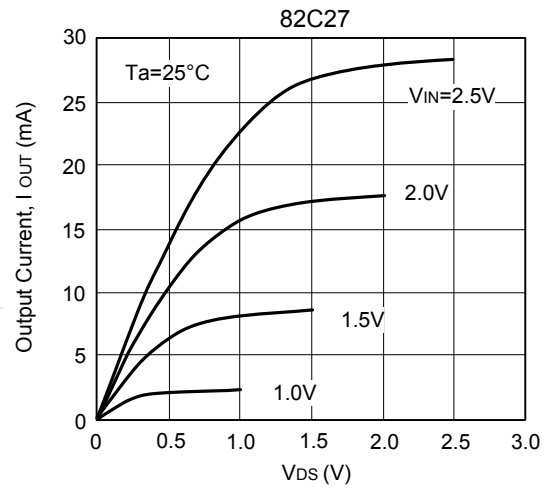
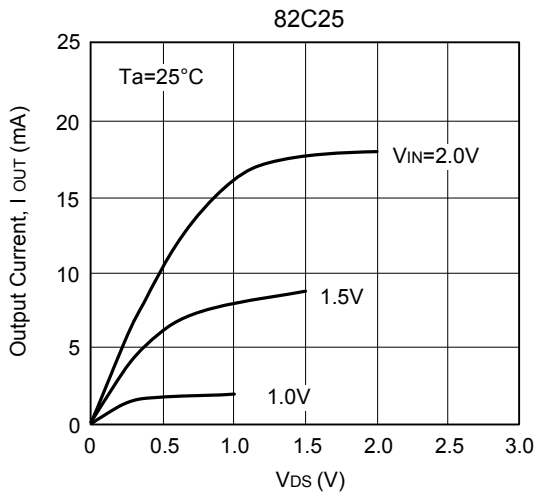
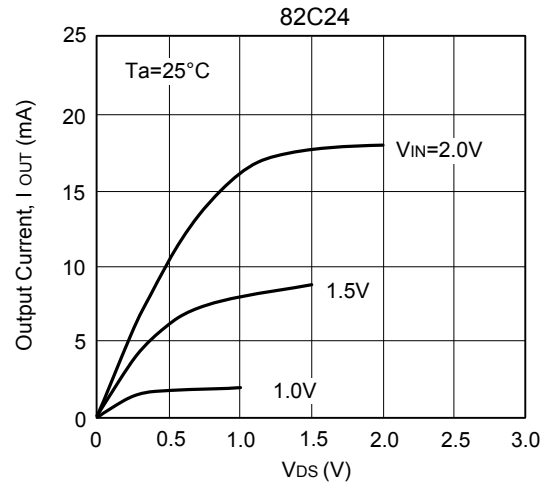
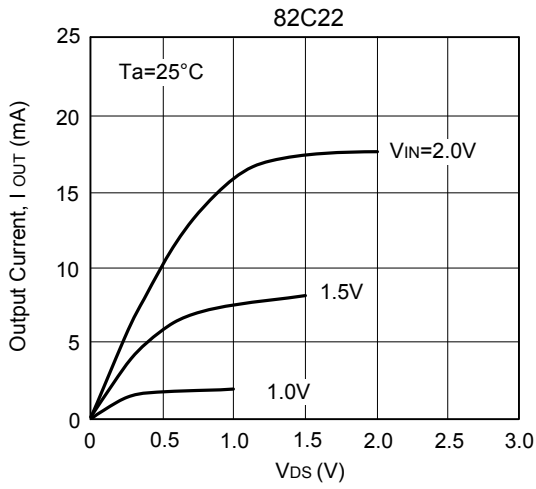

■ TYPICAL PERFORMANCE CHARACTERISTICS (Cont.)

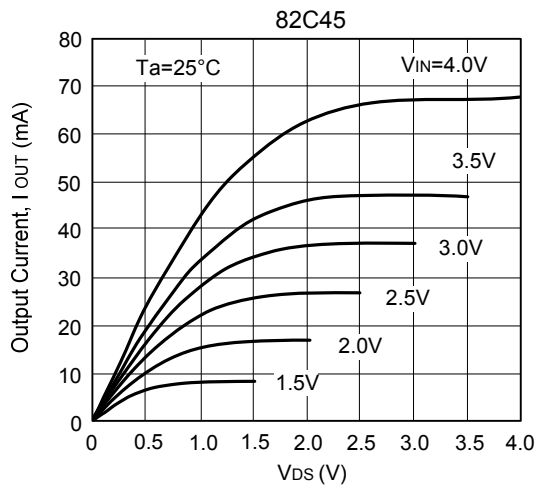

UTC assumes no responsibility for equipment failures that result from using products at values that exceed, even momentarily, rated values (such as maximum ratings, operating condition ranges, or other parameters) listed in products specifications of any and all UTC products described or contained herein. UTC products are not designed for use in life support appliances, devices or systems where malfunction of these products can be reasonably expected to result in personal injury. Reproduction in whole or in part is prohibited without the prior written consent of the copyright owner. The information presented in this document does not form part of any quotation or contract, is believed to be accurate and reliable and may be changed without notice.