

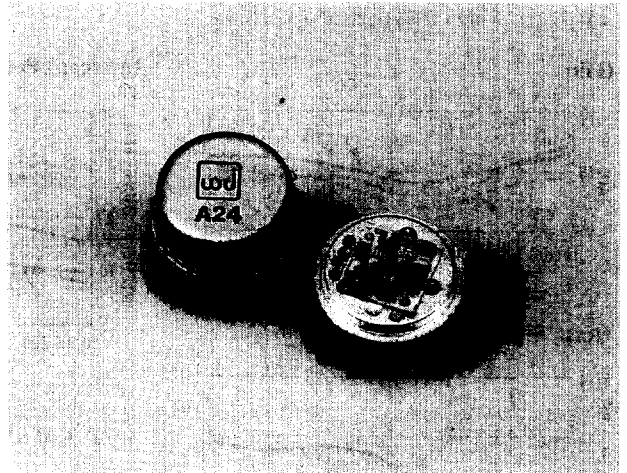

# A24 / SMA24

## 5 to 1500 MHz TO-8 CASCADABLE AMPLIFIER

- ◆ AVAILABLE IN SURFACE MOUNT
- ◆ HIGH GAIN - TWO STAGES: 20.0 dB (TYP.)
- ◆ ULTRA LOW PHASE DEVIATION  
FROM LINEARITY:  $< \pm 2.5^\circ$ , 100-1500 MHz
- ◆ LOW VSWR:  $< 1.4:1$  (TYP.)
- ◆ MEDIUM LEVEL OUTPUT: +8 dBm (TYP.)



### Specifications\*

Characteristics	Typical	Guaranteed	
		10° to 50°C	-54° to +85°C
Frequency (Min.)	2-1700 MHz	5-1500 MHz	5-1500 MHz
Small Signal Gain (Min.)	20.0 dB	19.0 dB	18.0 dB
Gain Flatness (Max.)	$< \pm 0.4$ dB	$\pm 0.8$ dB	$\pm 1.0$ dB
Noise Figure (Max.)	4.2 dB	5.3 dB	5.8 dB
Power Output at 1 dB Compression (Min.)	+8.0 dBm	+7.0 dBm	+6.5 dBm
VSWR (Max.) Input/Output	$< 1.4:1$	2.0:1	2.0:1
DC Current (Max.) at +15 Volts	34 mA	38 mA	40 mA

\*Measured in a 50-ohm system at +15 Vdc Nominal.

Notes:

1. WJ-CA24 is a standard WJ-A24 installed in a miniature SMA connector housing and guaranteed over 0°C to 50°C temperature range.

### Typical Intermodulation Performance at 25°C

Second Order Harmonic Intercept Point .....	+47 dBm (Typ.)
Second Order Two Tone Intercept Point .....	+42 dBm (Typ.)
Third Order Two Tone Intercept Point .....	+20.5 dBm (Typ.)

### Absolute Maximum Ratings

Storage Temperature .....	-62°C to +125°C
Maximum Case Temperature .....	125°C
Maximum DC Voltage .....	+20 Volts
Maximum Continuous RF Input Power .....	+7 dBm
Maximum Short Term RF Input Power .....	32 Milliwatts (1 Minute Max.)
Maximum Peak Power .....	0.5 Watt (3 $\mu$ sec Max.)
"S" Series Burn-in Temperature (Case) .....	125°C

Weight approximately 2.27 grams (0.08 oz.) max.

### Outline Drawings

A24

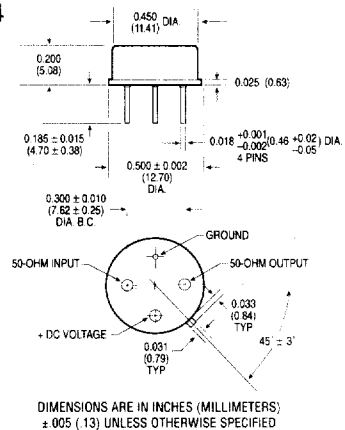

SMA24

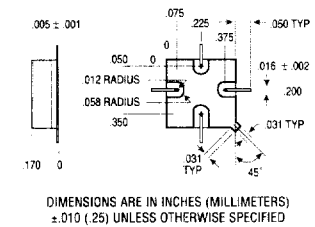
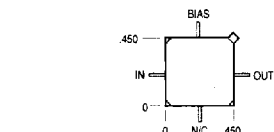

CA24

See note 1

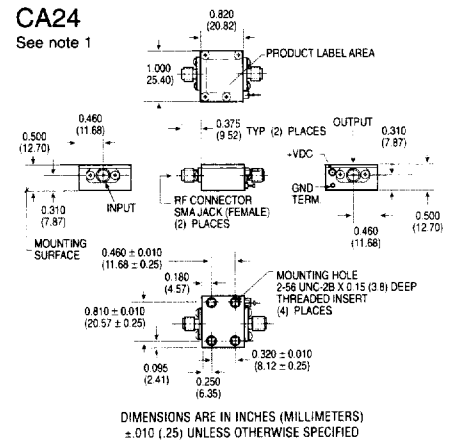

# Typical Performance at 25°C

WJ-A24/SMA24

## Gain

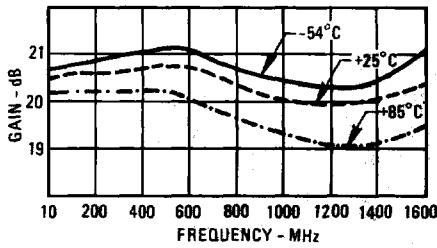

## Power Output\*

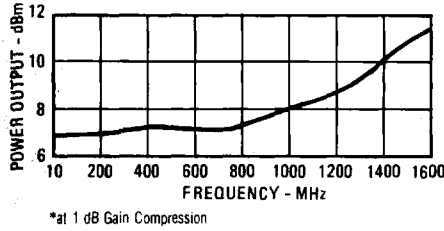

## VSWR Input

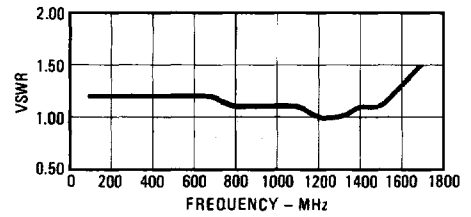

## Noise Figure

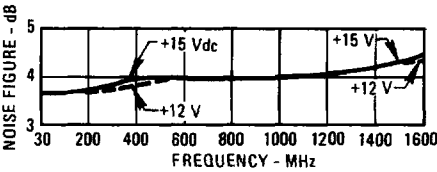

## VSWR Output

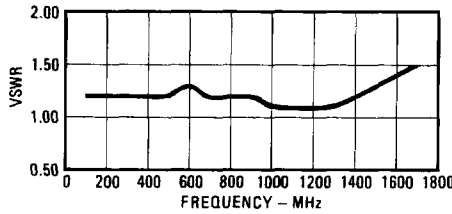

## Intercept Point, 3rd Order Two Tone

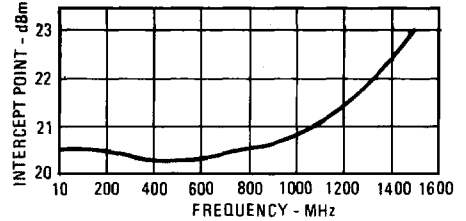

## Typical Automatic Test Data

### V<sub>CC</sub> = 15.0 V

Frequency MHz	VSWR IN	VSWR OUT	GAIN DB
1.0	1.5	1.4	20.3
2.0	1.2	1.2	20.4
5.0	1.1	1.1	20.5
10.0	1.0	1.1	20.5
50.0	1.0	1.1	20.6
100.0	1.0	1.2	20.7
200.0	1.1	1.2	20.8
300.0	1.0	1.3	20.7
400.0	1.1	1.2	20.3
500.0	1.1	1.2	20.2
600.0	1.2	1.2	20.4
700.0	1.2	1.2	20.6
800.0	1.3	1.2	20.7
900.0	1.4	1.2	20.8
1000.0	1.4	1.2	21.0
1100.0	1.5	1.2	21.0
1200.0	1.5	1.2	20.9
1300.0	1.6	1.1	21.0
1400.0	1.5	1.1	21.0
1500.0	1.5	1.2	21.1
1600.0	1.5	1.4	21.1
1700.0	1.7	1.7	21.0

### V<sub>CC</sub> = 12.0 V

Frequency MHz	VSWR IN	VSWR OUT	GAIN DB
1.0	1.3	1.4	19.8
2.0	1.2	1.2	19.9
5.0	1.1	1.1	20.0
10.0	1.1	1.1	20.0
50.0	1.1	1.1	20.1
100.0	1.1	1.2	20.1
200.0	1.1	1.2	20.3
300.0	1.1	1.3	20.2
400.0	1.1	1.2	19.9
500.0	1.2	1.2	19.7
600.0	1.2	1.2	20.0
700.0	1.3	1.2	20.1
800.0	1.3	1.2	20.3
900.0	1.4	1.2	20.4
1000.0	1.5	1.2	20.5
1100.0	1.5	1.2	20.6
1200.0	1.5	1.1	20.5
1300.0	1.6	1.1	20.5
1400.0	1.6	1.1	20.5
1500.0	1.5	1.3	20.7
1600.0	1.6	1.5	20.6
1700.0	1.8	1.8	20.3

## Linear S-Parameters

Frequency MHz	S11		S21		S12		S22	
	MAG	ANG	MAG	ANG	MAG	ANG	MAG	ANG
1.0	.187	-64	10.404	22	.028	18	.155	-97
2.0	.092	-77	10.517	11	.024	4	.092	-117
5.0	.029	-68	10.627	3	.023	3	.061	-146
10.0	.019	-36	10.633	0	.024	2	.056	-161
50.0	.019	-49	10.680	-10	.024	0	.061	-173
100.0	.021	-65	10.786	-21	.024	-1	.073	179
200.0	.028	-128	11.014	-45	.026	-4	.101	152
300.0	.014	-173	10.824	-69	.027	-10	.117	119
400.0	.034	-29	10.407	-91	.028	-18	.108	83
500.0	.068	-72	10.193	-111	.028	-26	.084	55
600.0	.091	-101	10.483	-132	.026	-33	.076	37
700.0	.110	-115	10.678	-154	.026	-37	.083	15
800.0	.131	-129	10.894	-177	.025	-42	.090	-13
900.0	.152	-148	11.004	160	.025	-46	.096	-39
1000.0	.176	-165	11.176	136	.025	-52	.093	-69
1100.0	.196	176	11.215	112	.024	-59	.092	-100
1200.0	.204	158	11.139	88	.025	-64	.083	-130
1300.0	.219	137	11.184	64	.024	-68	.063	-171
1400.0	.212	114	11.236	38	.026	-74	.057	122
1500.0	.198	79	11.415	12	.027	-82	.089	54
1600.0	.203	32	11.414	-18	.030	-90	.164	8
1700.0	.246	-27	11.279	-50	.035	-101	.246	-30

## Linear S-Parameters

Frequency MHz	S11		S21		S12		S22	
	MAG	ANG	MAG	ANG	MAG	ANG	MAG	ANG
1.0	.146	-64	9.783	22	.028	18	.157	-98
2.0	.091	-65	9.923	11	.026	6	.094	-119
5.0	.043	-38	10.019	3	.024	3	.063	-148
10.0	.040	-15	10.024	0	.024	2	.058	-162
50.0	.038	-32	10.071	-10	.025	0	.063	-175
100.0	.039	-43	10.174	-21	.025	-1	.074	177
200.0	.045	-92	10.345	-45	.027	-4	.098	151
300.0	.025	-98	10.226	-69	.028	-11	.112	119
400.0	.042	-61	9.851	-91	.029	-17	.104	84
500.0	.084	-90	9.659	-111	.028	-26	.079	55
600.0	.110	-109	9.947	-132	.027	-31	.070	37
700.0	.124	-122	10.146	-155	.027	-36	.075	14
800.0	.147	-137	10.362	-178	.026	-40	.079	-14
900.0	.168	-155	10.490	159	.026	-47	.082	-41
1000.0	.187	-175	10.599	135	.026	-52	.077	-71
1100.0	.207	168	10.655	111	.025	-56	.072	-104
1200.0	.215	150	10.596	86	.025	-62	.062	-139
1300.0	.226	128	10.626	62	.026	-68	.045	165
1400.0	.226	102	10.647	36	.028	-74	.060	89
1500.0	.213	66	10.780	9	.029	-81	.113	36
1600.0	.226	19	10.719	-21	.033	-91	.196	-3
1700.0	.282	-37	10.402	-54	.037	-105	.277	-38

## Thermal Data: V<sub>CC</sub> = 15 Vdc

Thermal Resistance  $\theta_{JC}$  ..... 141°C/W  
 Transistor Power Dissipation  $P_D$  ..... 0.185 W  
 Junction Temperature Rise Above Case  $T_{JC}$  ..... 26°C