

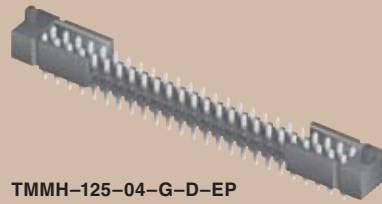

(2,00mm) .0787"

TMMH SERIES



TMMH-125-04-G-D-EP

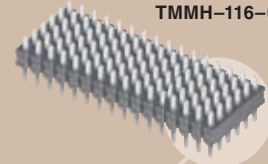

TMMH-116-04-T-6

FLEXIBLE THROUGH-HOLE HEADER

SPECIFICATIONS

For complete specifications see www.samtec.com?TMMH

Insulator Material:
Black Liquid Crystal Polymer



Terminal Material:
Phosphor Bronze

Plating:

Sn or Au over 50µ" (1,27µm) Ni

Operating Temp Range:

-55°C to +105°C with Tin;

-55°C to +125°C with Gold

Voltage Rating:

500 VAC mated with SQW

RoHS Compliant:

Yes

Lead-Free Solderable:

Yes

Mates with:
CLT, SQT, SQW,
ESQT, TLE, SMM,
MMS, TCSD



Choice of 2, 3, 4, 5 and 6 rows on (2,00mm) .0787" pitch

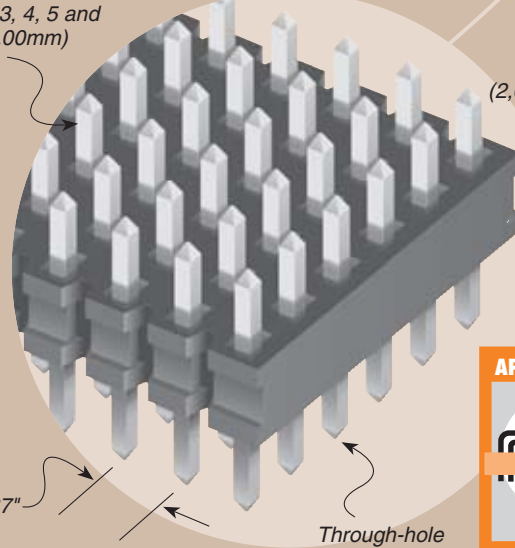

(2,00mm) .0787"

(2,00mm) .0787"

Through-hole

APPLICATION

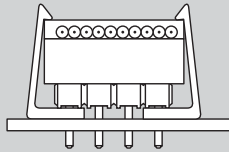

Retention Clip Option (-RC)

APPLICATIONS

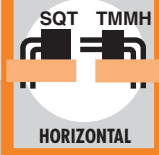

CURRENT RATING		
AMBIENT TEMP	Mated with	
	ESQT	SQW
20°C	5.8A	5A
40°C	5.1A	4.6A
60°C	4.5A	4A
95°C	2.9A	2.6A

6 POSITIONS (2x3) POWERED

TMMH

1

NO. PINS PER ROW

LEAD STYLE

PLATING OPTION

03 thru 50

Specify LEAD STYLE from chart

Also Available

Press Fit
See PTT Series.

Surface Mount
See previous page.

Low Profile
See TMM Series.

Right Angle Four Row
See TMM Series.

Shrouded Four Row Vertical & Right Angle
See TMMS Series.

Paste In Hole (PIH) processing. Contact Samtec ASP Group.

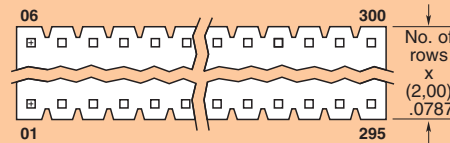

OPTION	Z	LEAD STYLE	A	B	C
-ES	(2,92) .115	-01	(7,67) .302	(3,20) .126	(2,46) .097
-EC	(4,70) .185	-04	(6,45) .254	(1,91) .075	(2,57) .101
-EP & -EPC	(6,10) .240	-05	(5,94) .234	(1,65) .065	(2,29) .090
-EL & -EBC	(4,45) .175	-06	(8,74) .344	(3,20) .126	(3,53) .139

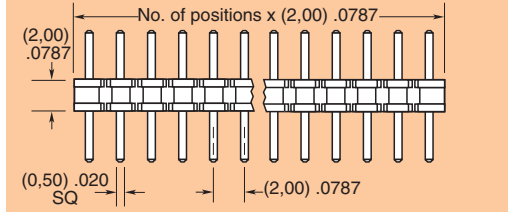
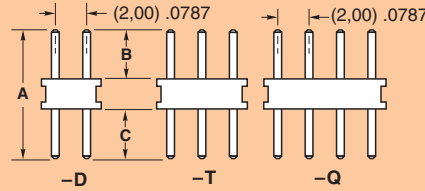
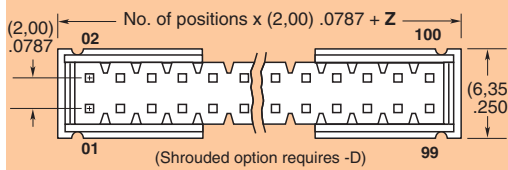

- F = Gold flash on post, Matte Tin on tail
- L = 10µ" (0,25µm) Gold on post, Matte Tin on tail
- G = 20µ" (0,51µm) Gold on post, Gold flash on tail
- T = Matte Tin

Note: Other Gold plating options available. Contact Samtec.

Due to technical progress, all designs, specifications and components are subject to change without notice.

WWW.SAMTEC.COM

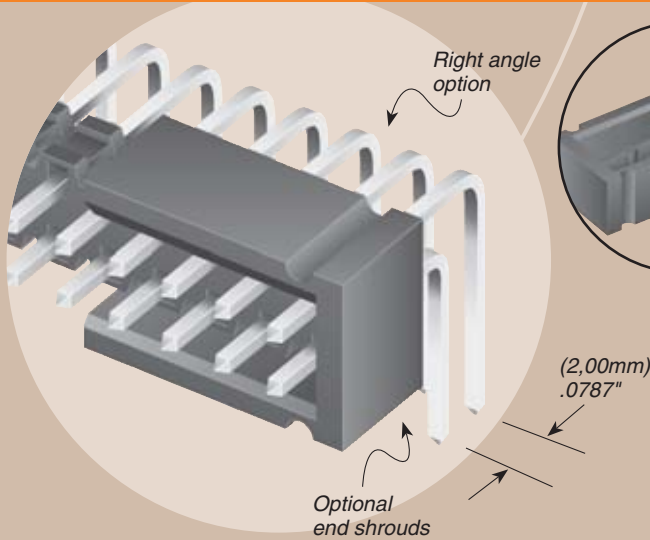
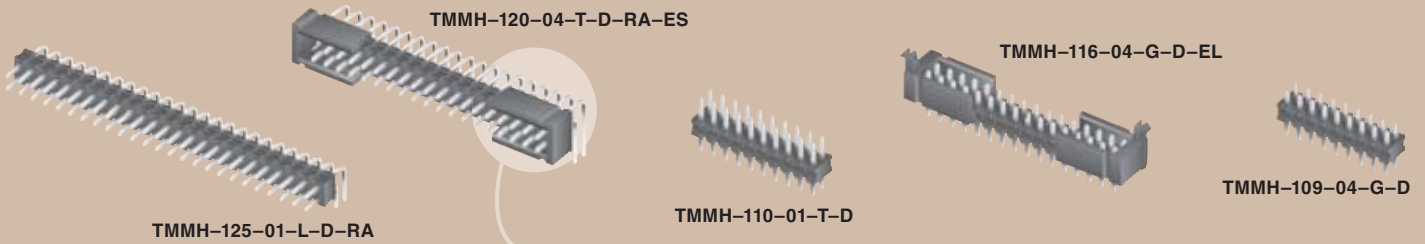

FLEX SHROUD OPTIONS

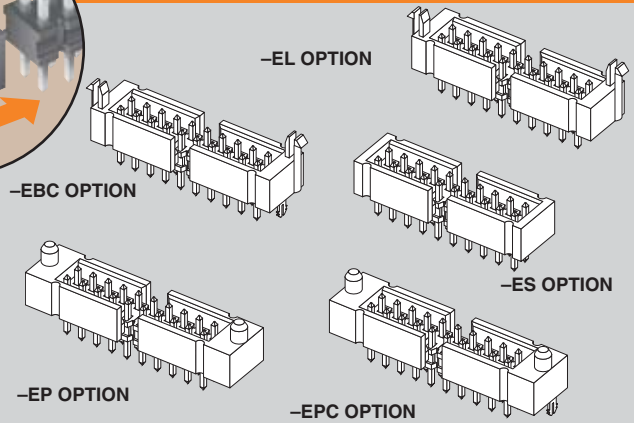

ROW OPTION

- D**
= Double Row
(Required for Flex Shroud option)
- T**
= Triple Row
- Q**
= Four Row
- 5**
= Five Row
- 6**
= Six Row

TAIL OPTION

- RA**
= Right Angle
(Double & Triple Row only)
(-ES, -EP, -EL Double Row only)
(-EC, -EBC and -EPC not available)
(-06 Lead style not available)

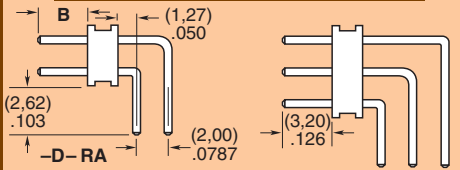

-T-RA
(Lead style -01 only)

LEAD STYLE	X	Y
-01	(5,84) .230	(4,45) .175
-04 & -05	(4,50) .177	(3,02) .119

LEAD STYLE	D	E
-01	(2,34) .092	(6,60) .260
-04	(2,62) .103	(5,26) .207
-05	(3,12) .123	(5,26) .207

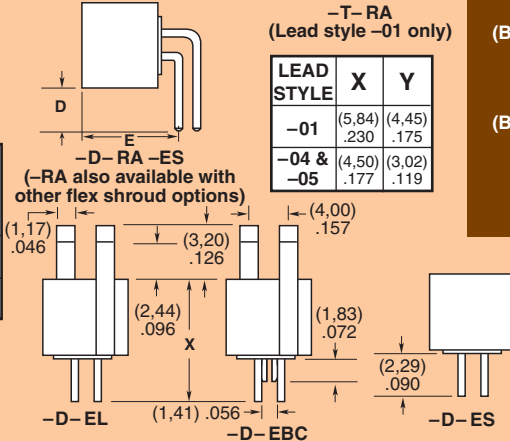

FLEX SHROUD OPTIONS

Flex Shroud requires -D row & 9 pins/row minimum
(For board-to-board interfaces. Will not mate with TCSD)

- ES**
= End Shroud
- EC**
= End Shroud with Locking Clip
(Manual placement required)
- EP**
= End Shroud with Guide Post
- EL**
= End Shroud with Board Lock
(Boards are positively locked and cannot be unmated)
- EBC**
= End Shroud with Board Lock and Locking Clip
(Boards are positively locked and cannot be unmated)
- EPC**
= End Shroud with Guide Post and Locking Clip
(Manual placement required)

OTHER OPTIONS

- “XXX”**
= Polarized Position
(Specify position of omitted pin)
- RC**
= Retention Clip
(Mates to TCSD)
(Double row only, minimum position 4 and available only -06 lead style)

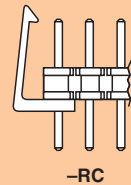

Due to technical progress, all designs, specifications and components are subject to change without notice.

WWW.SAMTEC.COM