

SMA IN-SERIES: Stainless Steel Adapters

Plug to Plug

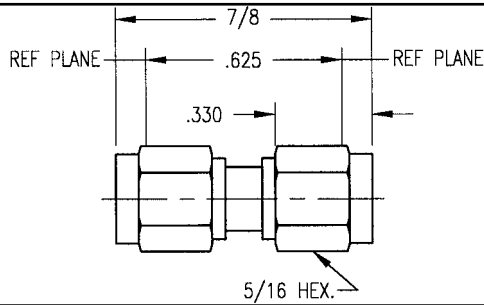

Part Number
250-250-0000G

- Part number shown is for gold plated.
- For passivated version change suffix to "P".

Jack to Jack

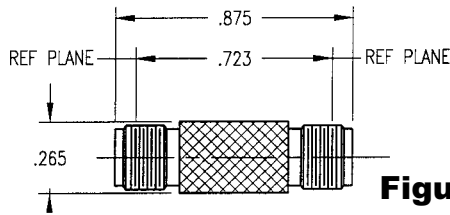

Figure 1

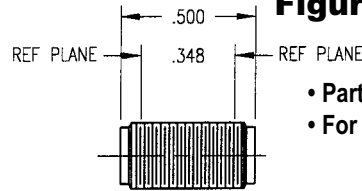
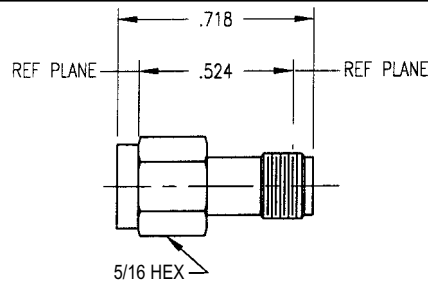

Figure 2

Part Number	Figure
251-251-0000G	1
251-251-0001G	2

- Part number shown is for gold plated.
- For passivated version change suffix to "P".

Plug to Jack



Part Number
250-251-0000G

- Part number shown is for gold plated.
- For passivated version change suffix to "P".

Right Angle Plug to Plug

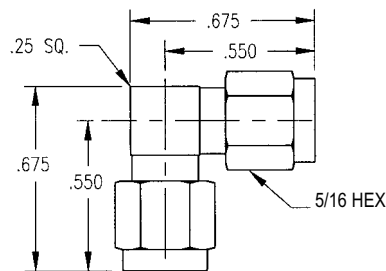

Part Number
252-252-0000G

- Part number shown is for gold plated.
- For passivated version change suffix to "P".

Right Angle Jack to Jack

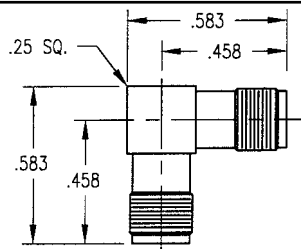

Part Number
253-253-0000G

- Part number shown is for gold plated.
- For passivated version change suffix to "P".

Right Angle Plug to Jack

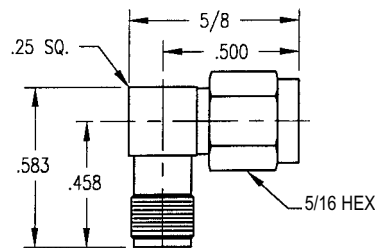

Part Number
252-253-0000G

- Part number shown is for gold plated.
- For passivated version change suffix to "P".

Note: Dimensions shown in inches.

Winchester/Retconn