

FEATURES

- High output 15A
- 3.3V ±5%, 5/12V ±10% Input
- Regulation ±0.4% line and load
- Industry standard pin configuration
- High efficiency to 91%
- Remote Sense, Trim and Enable
- Short Circuit protection
- MTBF 2.9 million hours
- Output voltage trimmable down to 0.6V using the optional
- voltage reference
- Can source and sink output current

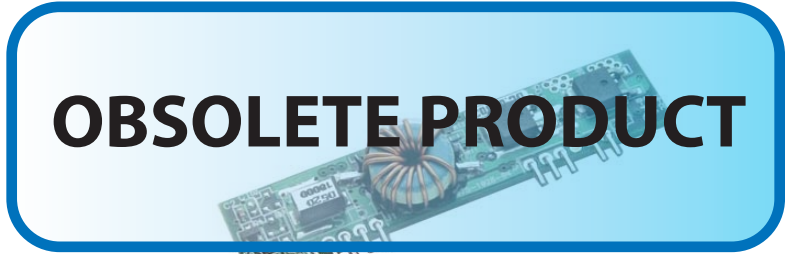

This product is not fuse protected. User is responsible for providing system protection. Consult factory for application information.

Specifications *	S151-03	S151-05	S151-12	
INPUT SPECIFICATIONS				
Input voltage range	3.3V ± 10%	5.0V ± 10%	12V ± 10%	Measured at +Vin pin
External input capacitor	Minimum 680µF			See also note on pg 9 and charts on pg 7
OUTPUT SPECIFICATIONS				
Standard output voltages	0.8V			Outputs 0.8V and 1.0V trimmable down to 0.6V using the on-board voltage reference (option 7 or F, see pg 2 and trimming equations on pg 8). Standard setpoint accuracy varies from ±1.5% at the low end of the output voltage range, to ±3% at the high end. (see chart on pg 2) Contact factory for tighter tolerances. See note on pg 8 for trimming to different voltages.
	0.9V			
	1.2V	1.0V		
	1.5V	1.5V	1.5V	
	1.8V	1.8V	1.8V	
Output current	15A	15A	15A**	200 LFM at 70°C (see also derating curves page 5-6)
Load regulation	±0.5%			0 to 15A load
Line regulation	±0.5%			Over specified input voltage range
External output capacitor	>150µF with maxESR = 100mΩ			See also note on pg 9
Short circuit protection	18A (at 70°C) to 32A (at -40°C)			
GENERAL SPECIFICATIONS				
Enable ***	ON-open or low / OFF-high (max 15V)			
Efficiency	90% typical			See efficiency curves on pg 4
Isolation	Non-isolated			
Switching frequency	300kHz			Fixed
Approvals and Standards	UL 94V-0			
Protection	Fusing			Unit is not fused.
Operating Temperature ****	-40°C to 70°C			200 LFM at 70°C (see also derating curves)
Storage Temperature	-40°C to 85°C			Non-condensing
Weight	0.4 oz (11.3 gm)			
MTBF	2.7 million hours			Per RAC PRISM at 50°C ambient and 200 LFM

* All specifications are typical at nominal input, full load at 25°C unless otherwise stated.

** Max 10A for 5.0V output.

*** Pull below 0.4V and sink greater than 50 µA or leave open to enable the SIP; pull above 2V (do not exceed 15V) and source greater than 150 µA to disable the SIP.

**** The output capacitors must meet the max ESR = 100 mΩ requirement over the operating temperature range.



PART NUMBER CODING

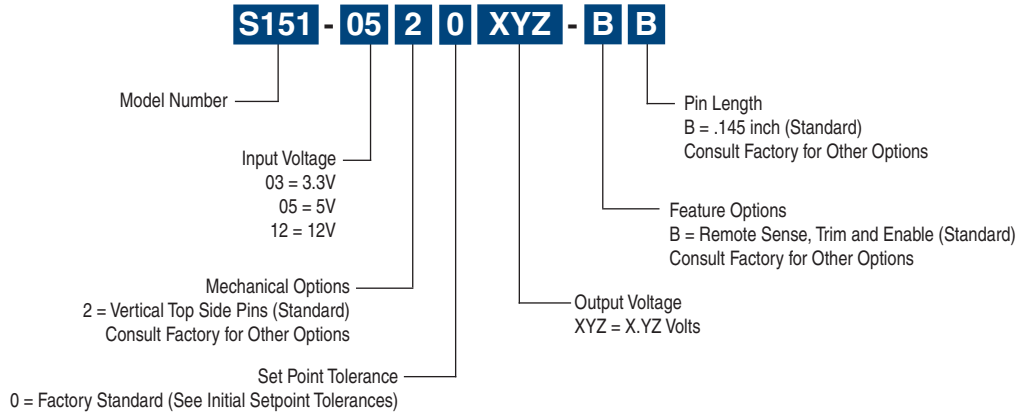

INITIAL SETPOINT TOLERANCE

Initial Setpoint Tolerance for 3.3V and 12V input SIPs

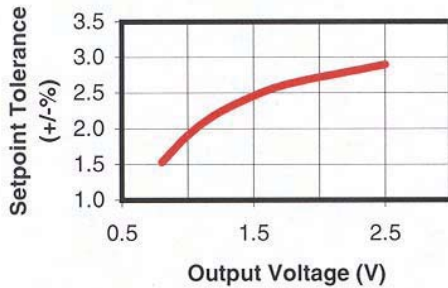

Initial Setpoint Tolerance for 5V input SIPs

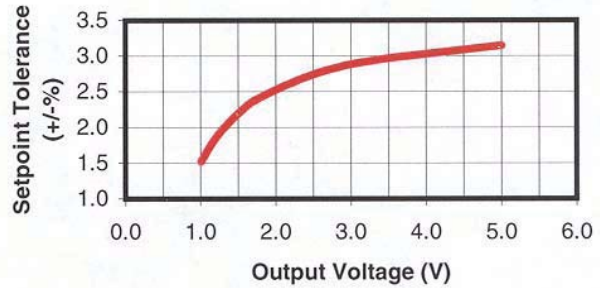

PIN ASSIGNMENT

CONNECTOR	PIN	FUNCTION	CONNECTOR	PIN	FUNCTION
J1	1	VOUT	J2	1	Ground
	2	VOUT		2	VIN
	3*	Remote Sense (Empty Optional)		3	VIN
	4	VOUT		4*	Empty (Reference Voltage Optional)
	5	Ground		5	Trim
				6	Enable

* Pin is present only when feature is selected.

MECHANICAL DIMENSIONS

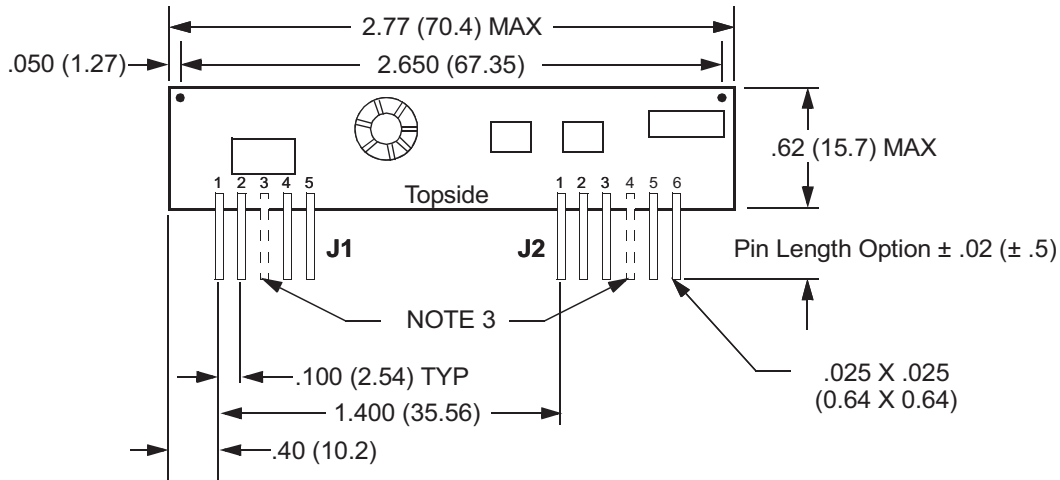

Mechanical Options 2

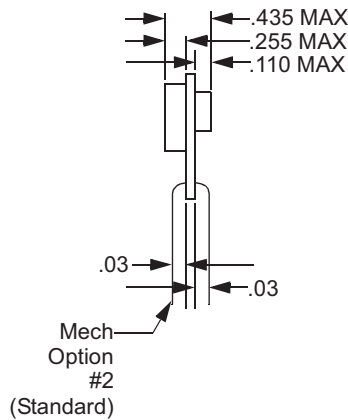

1. Dimensions are in inches and (millimeters).
2. Tolerances: (unless otherwise noted)

	<u>Inches</u>	<u>Millimeters</u>
	.XX ± .020	.X ± 0.5
	.XXX ± .010	.XX ± 0.25
Pin:	± .002	± 0.05

3. Pin is present only if feature is selected.

* Recommended Customer Hole Size 0.046 ±.003

EFFICIENCY CURVES AT 25°C

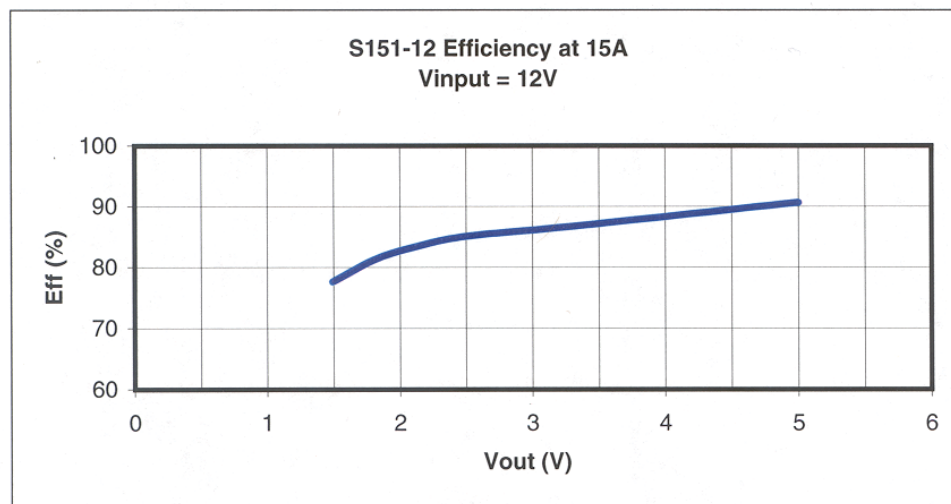
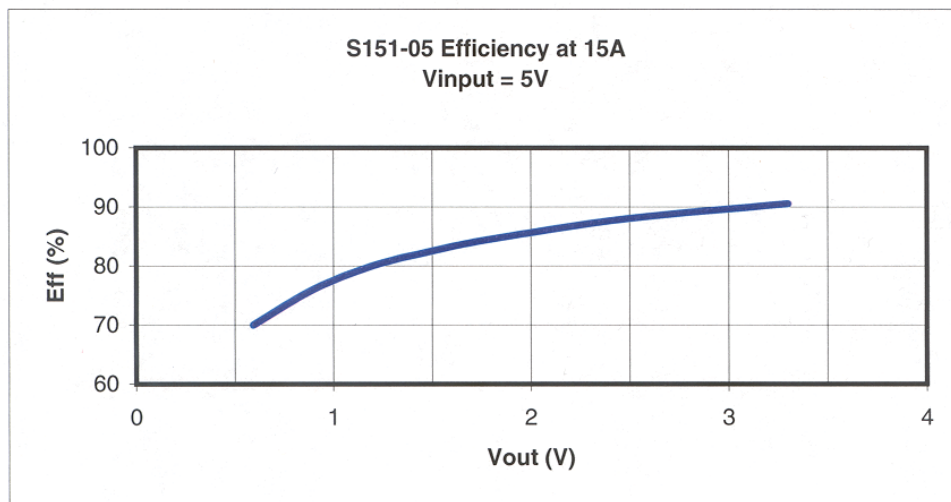
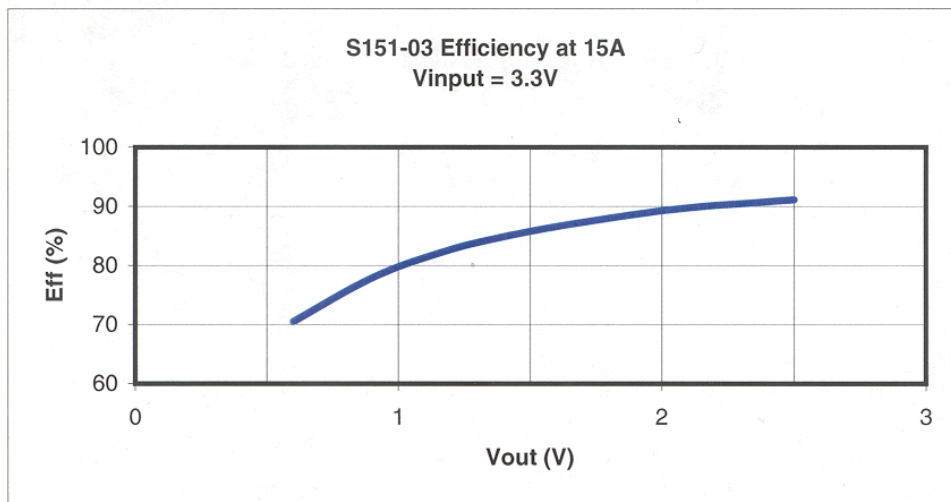

DERATING CURVES

No derating needed at 70°C with 200 LFM airflow or higher. *

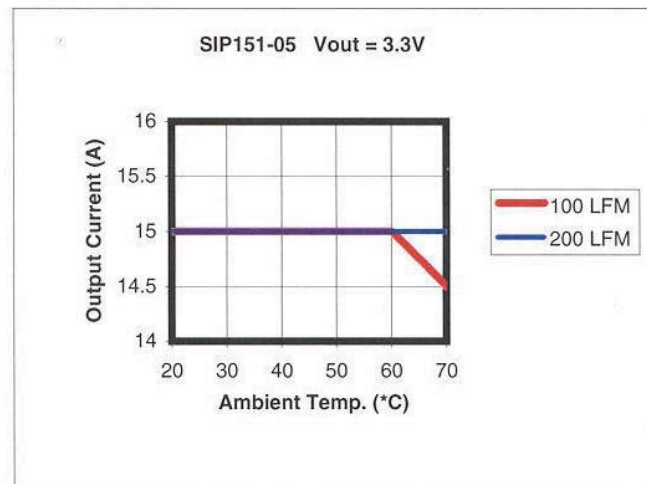
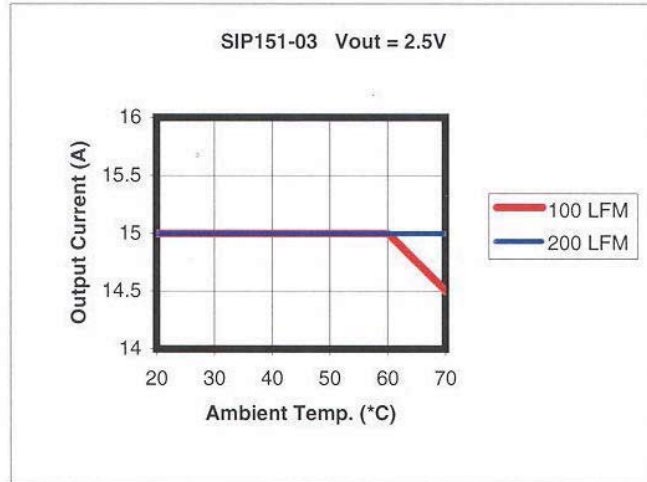

* Extended operation at greater than rated current may degrade reliability.

DERATING CURVES

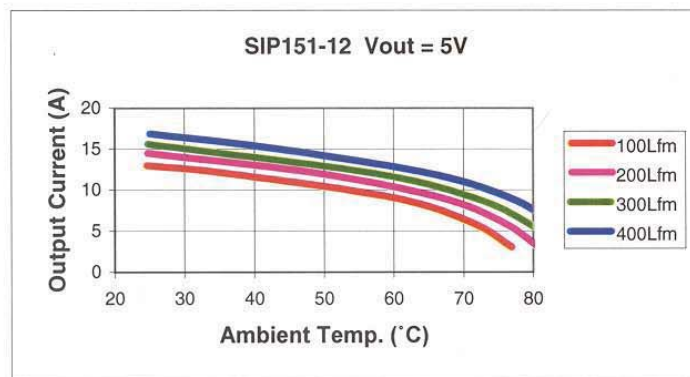
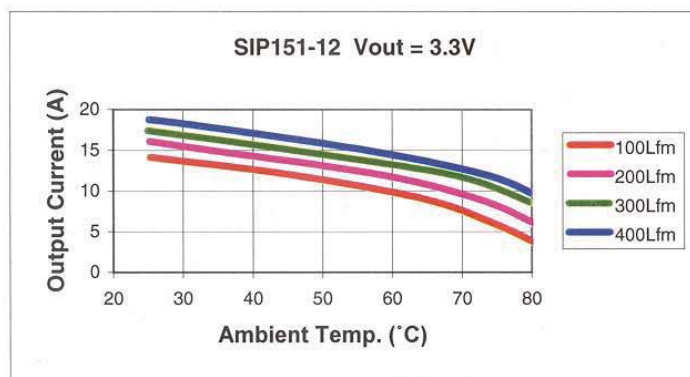
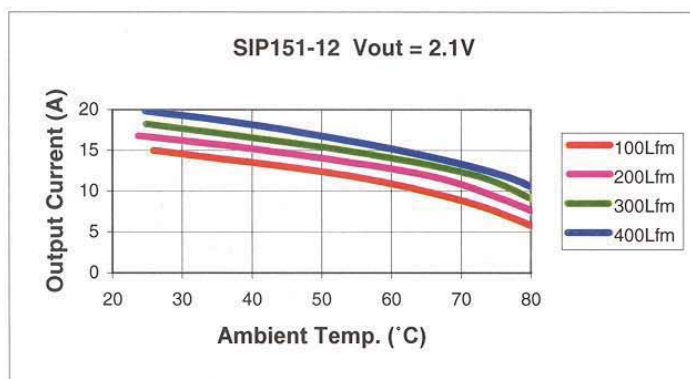
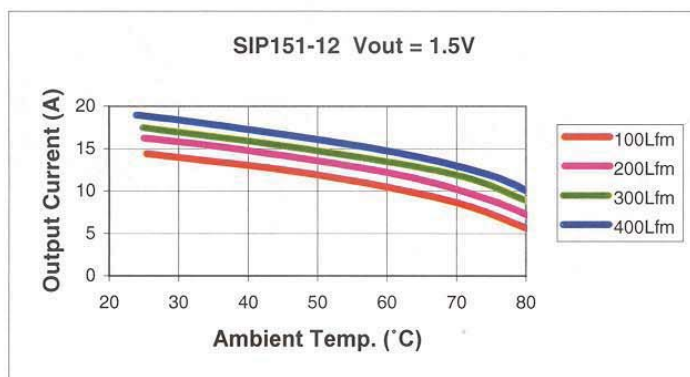

INPUT RIPPLE CURRENT

Approximate ripple current ratings required for input bulk capacitor

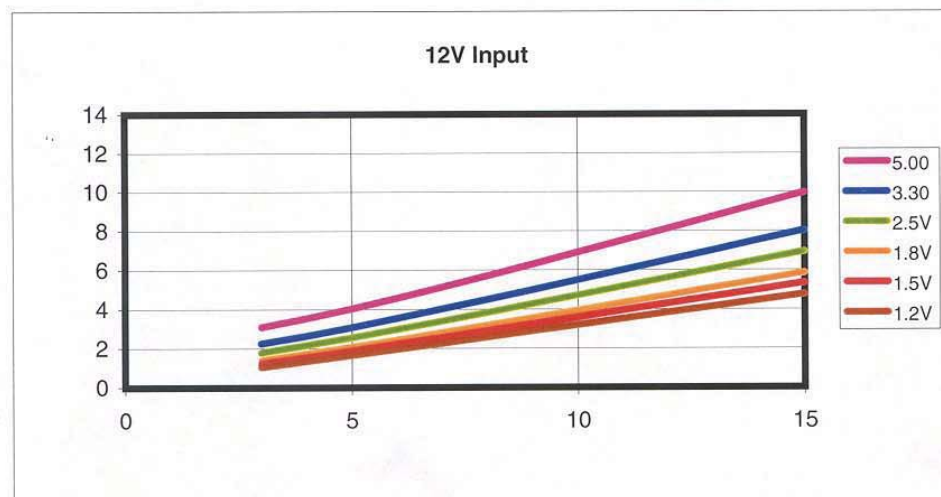
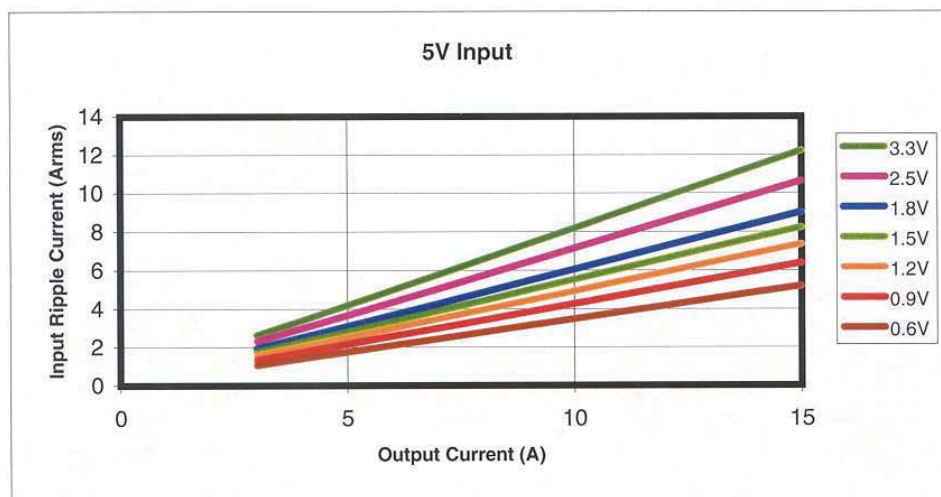
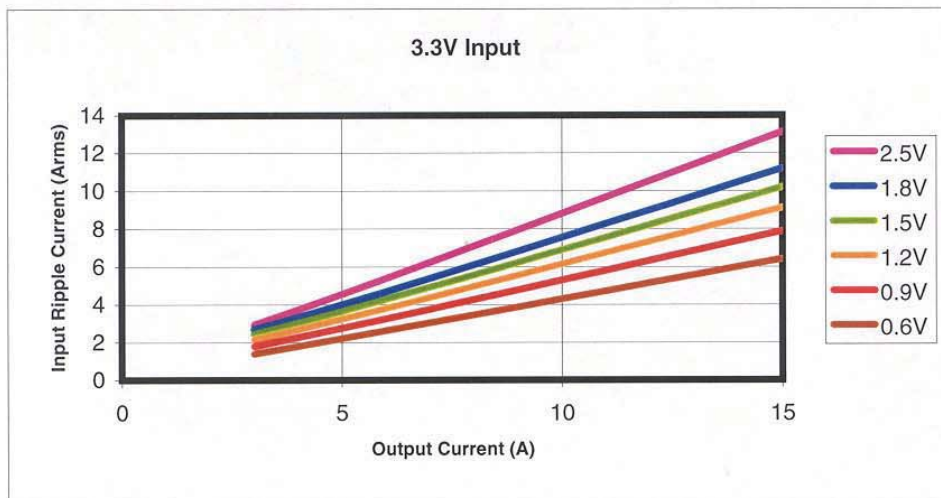

RESISTOR TRIM EQUATIONS

Resistor Trim Equations

NOTE: For best results, the trimming range should not exceed +/-20% of the initial output voltage set by the factory (V_{set}). To trim down to 0.6V, units with an initial output voltage of up to 1.2V can be used (applies to 3.3V and 5V input units only).

- **Trimming UP**—raising the output voltage using a resistor from Trim to Ground.

3.3V_{in} and 12V_{in}

$$R_{trim} = \frac{1992}{(V_{out} - V_{set})}$$

$$V_{out_{max}} = 2.5V$$

5V_{in}

$$R_{trim} = -500 \times \frac{(1 + V_{set} - V_{out})}{(V_{set} - V_{out})}$$

$V_{out_{max}} = V_{set} + 1$ as R_{trim} approaches 0Ω .

- **Trimming DOWN**—lowering the output voltage using a resistor from Trim to an external voltage reference or to the V_{out} pins.

3.3V_{in} and 12V_{in}

$$R_{trim} = 498 \times \frac{(4 - 5 \times V_{ref})}{(V_{out} - V_{set})}$$

$$V_{out_{min}} = 0.5V$$

5V_{in}

$$R_{trim} = -500 \times \frac{(-1 - V_{set} + V_{out} + V_{ref})}{(-V_{set} + V_{out})}$$

$V_{out_{min}} = V_{set} - (V_{ref} - 1)$ as R_{trim} approaches 0Ω .

Where:

V_{out} is the desired output voltage.

V_{set} is the output voltage setpoint (output voltage without trim).

V_{ref} is the reference voltage for the trim resistor when trimming down. If using V_{out} for this purpose, then $V_{ref} = V_{out}$.

R_{trim} is the resistance value of the trim resistor (ohms).

- **Trimming DOWN the S151** by using the on-board voltage reference. Connect a trim resistor from Trim to the Reference Voltage pin.

3.3V_{in}

$$R_{trim} = \frac{750}{(V_{set} - V_{out})} - 832$$

5V_{in}

$$R_{trim} = \frac{4233}{(V_{set} - V_{out})} - 1000$$

Where:

V_{out} is the desired output voltage.

V_{set} is the output voltage setpoint (output voltage without trim).

R_{trim} is the resistance value of the trim resistor (ohms).

External Capacitance for SIP Products

All SIP products require external capacitance to be placed on the system board that the SIP will be designed into. This application note is an attempt to explain how to translate datasheet information and apply it to a system level board design.

Input Capacitance

Although input capacitance value is not critical, the input capacitors must be capable of storing fairly large amounts of energy. This means, for example, small ceramic capacitors would be inappropriate. The primary criteria, though, for choosing the input capacitors is AC ripple current rating. The SIP datasheet contains a chart showing ripple current vs. output current (or output power). The system designer determines the maximum SIP output current required from the SIP. Based on that number, the chart will show a corresponding ripple current rating the designer needs to plan for when choosing input capacitors.

Example using SIP S151-05 for 1.5 V output:

The designer knows the S151 output current will be maximum 12.5A in his application. The ripple current chart (5V input) shows a 7A rating required for the input capacitor. Also known is that the capacitor the designer hopes to use has a ripple current rating of 3A. Therefore, the designer must use three of the chosen capacitors in parallel for a total ripple current capability of 9A. This will adequately cover the 7A need.

Output Capacitance

The only requirement for capacitance value is for basic circuit stability of the SIP. That value is specified on the SIP datasheet—usually 150 μ F. The other consideration for the output capacitor is the total ESR (Equivalent Series Resistance). As with ripple current, every capacitor has a specified ESR. When using multiple capacitors in parallel, this ESR is added exactly like parallel resistors. Therefore, more capacitors mean less ESR. The SIP datasheet specifies a maximum total ESR necessary for optimum SIP performance. The designer may also choose to add more capacitance to reduce output ripple and noise.

Example:

The datasheet specifies a maximum ESR of 100m Ω for output capacitance. The system designer wants to use a capacitor with a specified ESR of 130m Ω . Since 130m Ω is more than the needed 100m Ω , two capacitors must be used in parallel for a total effective ESR of 65m Ω .

Generally, good, low ESR bulk capacitors are recommended for both input and output capacitance so that fewer capacitors are needed since board real estate is usually an important factor in today's designs.

Impact on Output Voltage Ripple and Transient Response

If the customer's application requires a very low output voltage ripple and / or very low output voltage overshoot / undershoot during transients, then the guidelines previously shown need to be exceeded and good layout practices become mandatory.

By using four 330 μ F OSCON capacitors, each having ESR = 17m Ω , the output voltage ripple can be decreased to 50mVpk-pk on a 1.2V output SIP. Also during a transient load condition (load current steps from 20% to 100% and back, at 2 A / μ sec) the output voltage does not overshoot / undershoot more than 100mV.

When fast and deep transient loads are expected, the input capacitor becomes important as well, especially if the SIP is far from its input voltage source. Capacitors having as much as 2000 μ F and combined ESR lower than 20m Ω might be needed.

Practical results heavily depend on physical layout and specific load conditions. For critical applications the customer is encouraged to consult with the manufacturer.