



**Normally-ON Trench Silicon Carbide Power JFET**

**FEATURES:**

**SemiSouth Die Inside**

- Hermetic TO-257 Packaging
- 200°C Maximum Operating Temperature (260°C Contact Factory)
- Available Screening:
  - MIL-PRF-19500 Equivalent
  - Space Level
  - MIL-STD-750 Methods & Conditions
- Inherent Radiation Tolerance >100K TID
- Positive Temperature Coefficient for Ease of Paralleling
- Extremely Fast Switching with No "Tail" Current at 150°C
- 1200 Volt Drain-Source Blocking Voltage
- $RDS_{(on)max}$  of 0.085  $\Omega$
- Voltage Controlled
- Low Gate Charge
- Low Intrinsic Capacitance

**APPLICATIONS:**

- Satellite Solar Inverters
- Mil Spec Power Supplies
  - Switch Mode
  - Uninterrupted
- Jet Engine Electronics
- Down-hole Electronics (Motor / Compressor Control)



TO-257

Product Summary		
$BV_{DS}$	1200	V
$RDS_{(ON)max}$	0.085	$\Omega$
$E_{TS,typ}$	TBD	$\mu J$

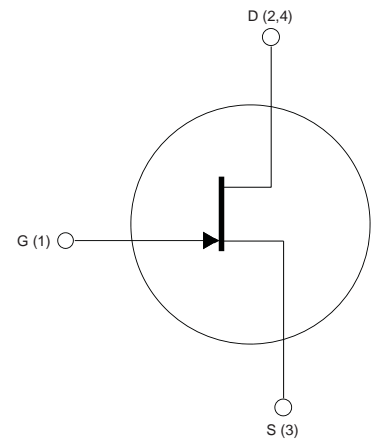

Internal Schematic

Non-isolated tab version shown. For isolated tab version, tab (4) is No Connect.

**MAXIMUM RATINGS**

Parameter	Symbol	Conditions	Value	Unit
Continuous Drain Current	$I_{D, Tj=100}$	$T_j = 100\text{ }^\circ\text{C}$	52	A
	$I_{D, Tj=150}$	$T_j = 150\text{ }^\circ\text{C}$	43	
Pulsed Drain Current <sup>(1)</sup>	$I_{DM}$	$T_c = 25\text{ }^\circ\text{C}$	75	A
Short Circuit Withstand Time	$t_{SC}$	$V_{DD} < 800\text{ V}, T_c < 125\text{ }^\circ\text{C}$	50	$\mu\text{s}$
Power Dissipation	$P_D$	$T_c = 25\text{ }^\circ\text{C}$	114	W
Gate-Source Voltage	$V_{GS}$	AC <sup>(2)</sup>	-15 to +15	V
Operating and Storage Temperature	$T_j, T_{j, stg}$		-55 to +200*	$^\circ\text{C}$
Lead Temperature for Soldering	$T_{sold}$	1/8" from case < 10 s	260	$^\circ\text{C}$

(1) Limited by pulse width

(2)  $R_{GEXT} = 1\text{ ohm}, t_p < 200\text{ns}$ , see Figure 5 for static conditions

\*Consult factory for 260 $^\circ\text{C}$

**THERMAL CHARACTERISTICS**

Parameter	Symbol	Value		Unit
		Typ	Max	
Thermal Resistance, junction-to-case	$R_{th,JC}$	-	TBD	$^\circ\text{C} / \text{W}$
Thermal Resistance, junction-to-ambient	$R_{th,JA}$	-	TBD	

For more products and information, please visit our website at [www.micross.com](http://www.micross.com)



**ELECTRICAL CHARACTERISTICS**

Parameter	Symbol	Conditions	Value			Unit
			Min	Typ	Max	
<b>Off Characteristics</b>						
Drain-Source Blocking Voltage	$BV_{DS}$	$V_{GS} = -15\text{ V}, I_D = 600\ \mu\text{A}$	1200	-	-	V
Total Drain Leakage Current	$I_{DSS}$	$V_{DS} = 1200\text{ V}, V_{GS} = -15\text{ V}, T_j = 25^\circ\text{C}$	-	1	10	$\mu\text{A}$
		$V_{DS} = 1200\text{ V}, V_{GS} = -15\text{ V}, T_j = 150^\circ\text{C}$	-	10	200	
Total Gate Reverse Leakage	$I_{GSS}$	$V_{GS} = -15\text{ V}, V_{DS} = 0\text{ V}$	-	-0.1	-0.3	mA
		$V_{GS} = -15\text{ V}, V_{DS} = 1200\text{ V}$	-	-0.1	-	
<b>On Characteristics</b>						
Drain-Source On-resistance	$R_{DS(on)}$	$I_D = 43\text{ A}, V_{GS} = 2\text{ V}, T_j = 25^\circ\text{C}$	-	0.075	0.085	$\Omega$
		$I_D = 43\text{ A}, V_{GS} = 2\text{ V}, T_j = 100^\circ\text{C}$	-	0.14	-	
Gate Threshold Voltage	$V_{GS(th)}$	$V_{DS} = 1\text{ V}, I_D = 34\text{ mA}$	-6.00	-	-4.00	V
Gate Forward Current	$I_{GFWD}$	$V_{GS} = 2\text{ V}$	-	220	-	mA
Gate Resistance	$R_G$	$f = 1\text{ MHz}, \text{ drain-source shorted}$	-	8	-	$\Omega$
	$R_{G(on)}$	$V_{GS} > 2.7\text{ V}; \text{ See Figure 5}$	-	0.5	-	$\Omega$
<b>Dynamic Characteristics</b>						
Input Capacitance	$C_{iss}$	$V_{DD} = 100\text{ V}$	-	670	-	$\mu\text{F}$
Output Capacitance	$C_{oss}$		-	103	-	
Reverse Transfer Capacitance	$C_{rss}$		-	97	-	
Effective Output Capacitance, energy related	$C_{o(er)}$	$V_{DS} = 0\text{ V to } 600\text{ V}, V_{GS} = 0\text{ V}$	-	60	-	
<b>Switching Characteristics</b>						
Turn-On Delay	$t_{on}$	$V_{DS} = 600\text{ V}, I_D = 40\text{ A}, \text{ Inductive Load}, T_j = 25^\circ\text{C}$ Gate Driver = +15V, -15V $R_{GEXT} = 50\text{ ohm}$	-	TBD	-	ns
Rise Time	$t_r$		-	TBD	-	
Turn-Off Delay	$t_{off}$		-	TBD	-	
Fall Time	$t_f$		-	TBD	-	
Turn-On Energy	$E_{on}$		-	TBD	-	
Turn-Off Energy	$E_{off}$	$V_{DS} = 600\text{ V}, I_D = 40\text{ A}, \text{ Inductive Load}, T_j = 150^\circ\text{C}$ Gate Driver = +15V, -15V $R_{GEXT} = 50\text{ ohm}$	-	TBD	-	$\mu\text{J}$
Total Switching Energy	$E_{ts}$		-	TBD	-	
Turn-On Delay	$t_{on}$		-	TBD	-	
Rise Time	$t_r$		-	TBD	-	
Turn-Off Delay	$t_{off}$		-	TBD	-	
Fall Time	$t_f$	$V_{DS} = 600\text{ V}, I_D = 40\text{ A}, \text{ Inductive Load}, T_j = 150^\circ\text{C}$ Gate Driver = +15V, -15V $R_{GEXT} = 50\text{ ohm}$	-	TBD	-	ns
Turn-On Energy	$E_{on}$		-	TBD	-	
Turn-Off Energy	$E_{off}$		-	TBD	-	
Total Switching Energy	$E_{ts}$		-	TBD	-	
Total Gate Charge	$Q_g$		-	30	-	
Gate-Source Charge	$Q_{gs}$	$V_{DS} = 600\text{ V}, I_D = 40\text{ A}, V_{GS} = +2.5\text{ V}$	-	1	-	nC
Gate-Drain Charge	$Q_{gd}$		-	24	-	



Figure 1. Typical Output Characteristics

$I_D = f(V_{DS}); T_j = 25^\circ\text{C}; \text{parameter: } V_{GS}$

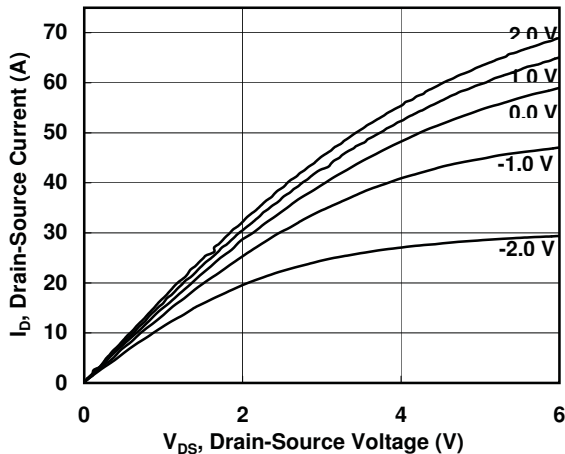

Figure 2. Typical Output Characteristics

$I_D = f(V_{DS}); T_j = 100^\circ\text{C}; \text{parameter: } V_{GS}$

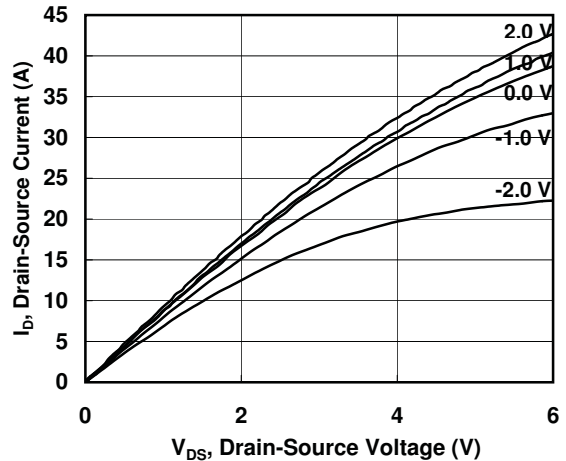

Figure 3. Typical Output Characteristics

$I_D = f(V_{DS}); T_j = 150^\circ\text{C}; \text{parameter: } V_{GS}$

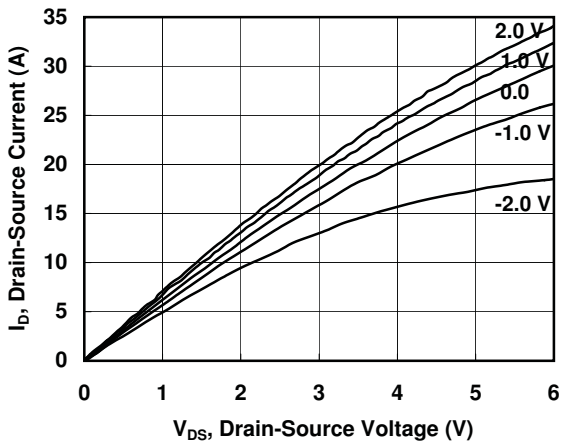

Figure 4. Typical Transfer Characteristics

$I_D = f(V_{GS}); V_{DS} = 5\text{V}$

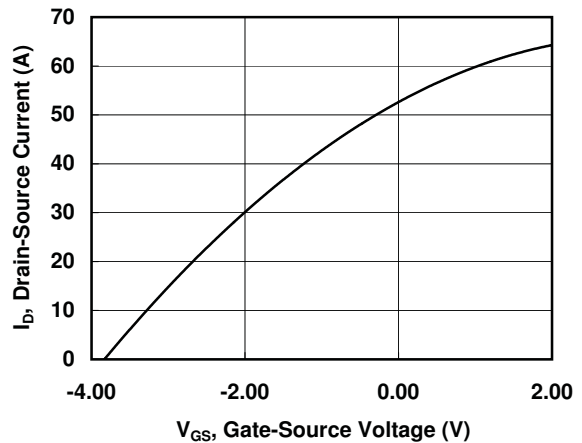

Figure 5. Gate-Source Current

$I_{GS} = f(V_{GS}); \text{parameter: } T_j$

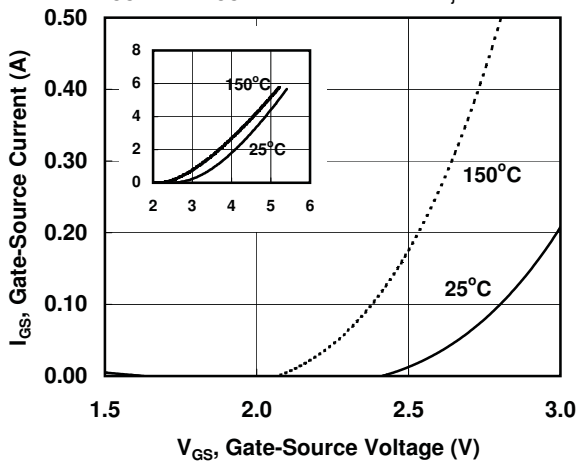

Figure 6. Drain-Source On-resistance

$R_{DS(on)} = f(I_D); V_{GS} = 2.0; \text{parameter: } T_j$

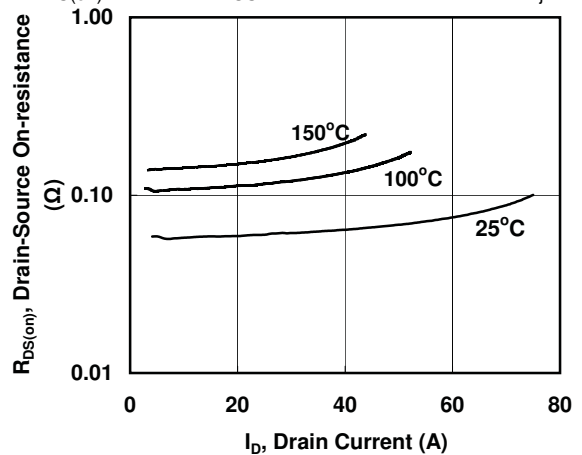



Figure 7. Drain-Source On-resistance

$R_{DS(ON)} = f(T_j)$ ; parameter:  $I_{GS}$

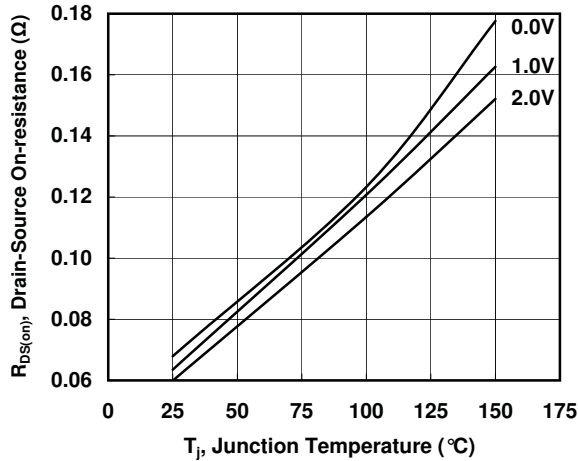

Figure 8. Drain-Source On-resistance

$R_{DS(ON)} = f(V_{GS})$ ;  $T_j = 25^\circ C$

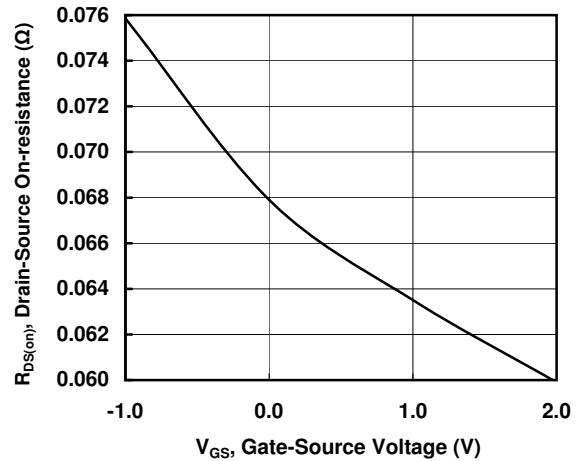

Figure 9. Typical Capacitance

$C = f(V_{DS})$ ;  $V_{GS} = 0 V$ ;  $f = 1 MHz$

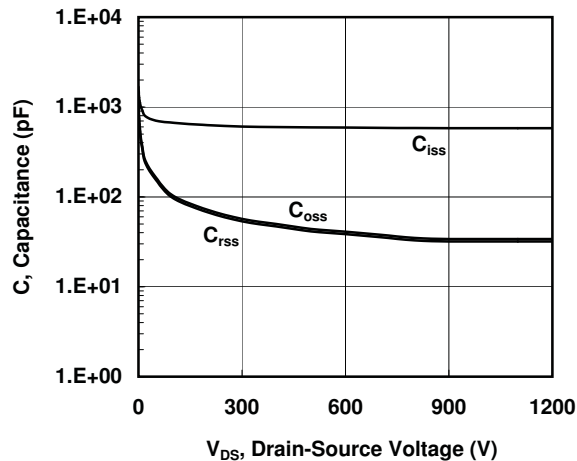

Figure 10. Gate Charge

$Q_g = f(V_{GS})$ ;  $V_{DS} = 600V$ ;  $I_D = 5A$ ,  $T_j = 25^\circ C$

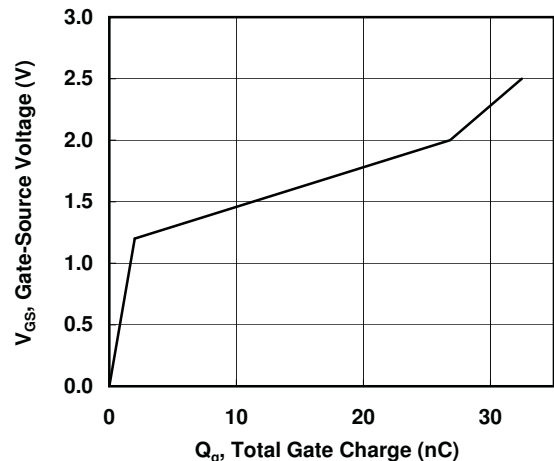

Figure 11. Gate Threshold Voltage

$V_{th} = f(T_j)$

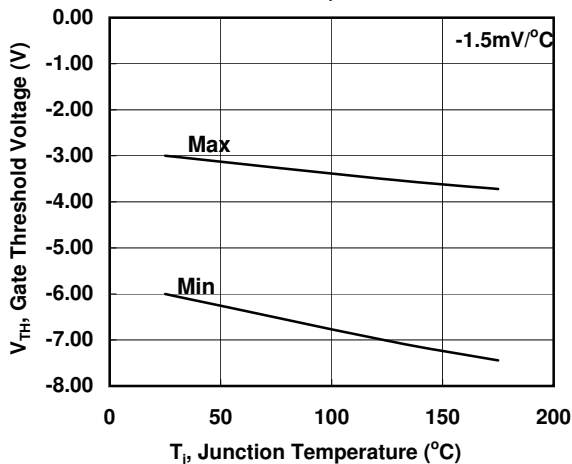
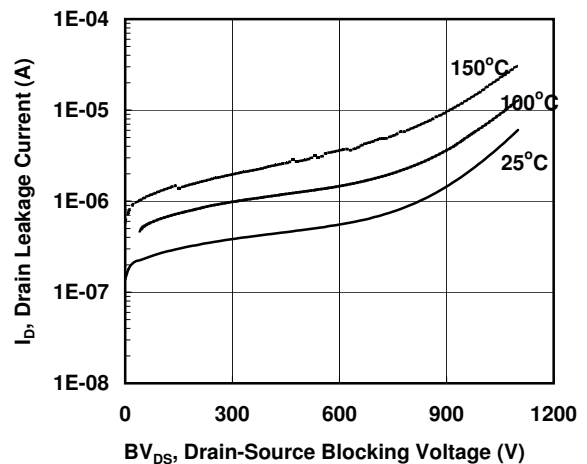

Figure 12. Drain-Source Leakage

$I_D = f(V_{DS})$ ;  $V_{GS} = 0V$ ; parameter:  $T_j$





**Figure 13. Transient Thermal Impedance**

$Z_{th(jc)} = f(t_p)$ ; parameter: Duty Ratio

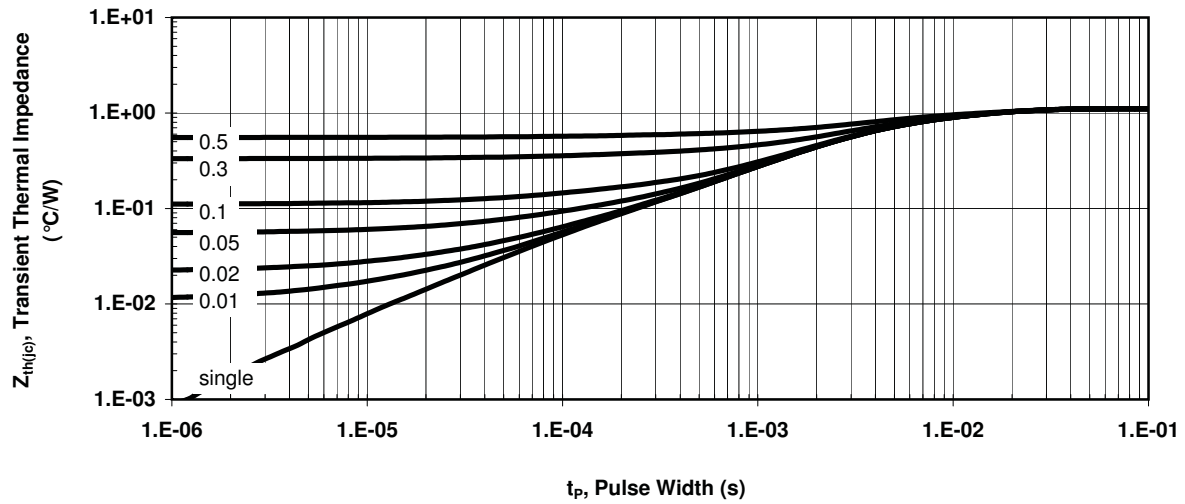



**MECHANICAL DRAWING**

**3-Lead TO257**

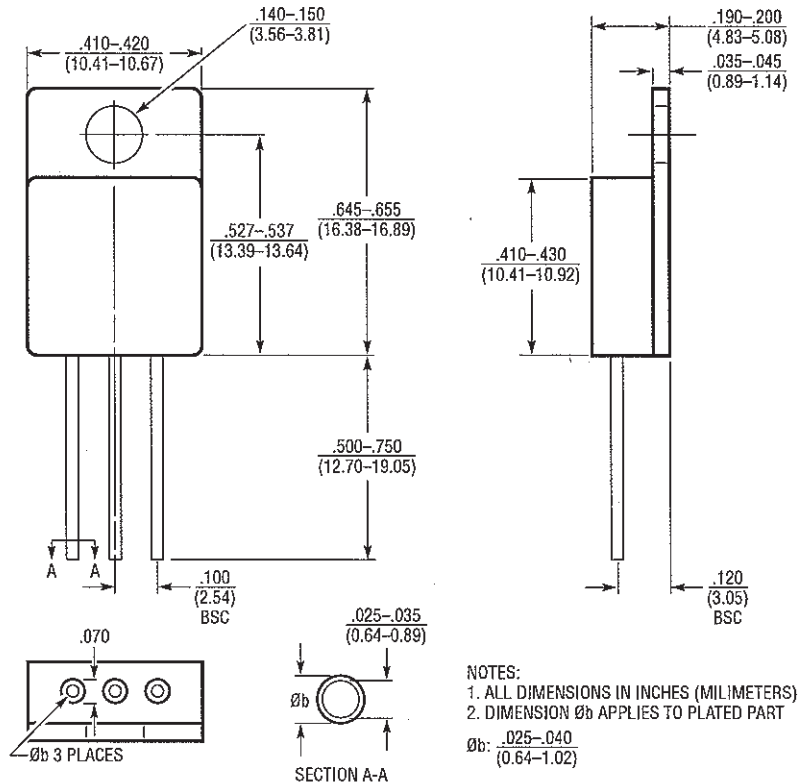

**ORDERING INFORMATION**

<u>Base Part Number</u>	<u>Configuration</u>	<u>Package</u>	<u>Junction Temp. Range</u>	<u>Processing</u>
ASJD1200R085	Blank= Non-isolated Tab S= Isolated Tab	Y=TO-257 -	EL EX	Blank /V /S

Temp Ranges: EL= Elevated Temp. Range, -55°C to 200°C (T<sub>J</sub>)  
EX= Extreme Temp. Range, -55°C to 260°C (T<sub>J</sub>) (consult factory)

Processing: Blank = Commercial / Standard Processing  
MIL-PRF-19500 Equivalent Processing Available Per SCD  
/V= JANTX MIL-PRF-19500 Equivalent (future standard offering)  
/S= JANS MIL-PRF-19500 Equivalent (future standard offering)

Example Part Numbers: ASJD1200R085SY-EL  
ASJD1200R085Y-EX

SemiSouth has commercial plastic versions of this product available. Please refer to the SemiSouth website <http://www.semisouth.com/products/products.html> for datasheet specifications and ordering information. The SemiSouth part number is SJDP120R085 and is supplied in a TO-247 plastic package.



**DOCUMENT TITLE**

Normally-ON Trench Silicon Carbide Power JFET

<u>Rev #</u>	<u>History</u>	<u>Release Date</u>	<u>Status</u>
0.0	Initial Release	November 2010	Advanced Information