

Type JAD micro fuse is designed for circuit protection against excessive current in portable electronic equipment, electronic circuit around battery etc. because the demand for high capacity batteries is increasing. Since it is designed as chip type, it is compact and the best suitable for portable use. Also, the ecology design of Type JAD is gentle because of complete lead-free.

FEATURES

1. A micro fuse in conformity to UL
2. Low fusing point element that is newly developed is applied.
Has excellent fusing and cutting characteristics.
3. Surface temperature rise is 100°C or less when applying twice rated current for fusing. This offers less influence on the peripheral units.
4. Small size of 3216 (3.2 × 1.6 × 1.6 mm), using resin mold and precision case
5. Suitable for automatic mounting
6. Precise dimensions allows high-density mounting and symmetrical construction of terminals provide "Self-Alignment".
7. Resistance to soldering heat : Reflow or flow soldering 10 seconds at 260°C
8. Standard package : 8 mm width tape carrier
9. LEAD FREE and RoHS Compliant

RATING

Item	Rating
Category Temperature Range	-40 ~+125°C
Rated Current	0.5-0.8-1.0-1.25-1.6-2.0-2.5-3.15-4.0A
Rated Voltage	24VDC
Voltage Drop	Refer to CATALOG NUMBERS AND RATING
Insulation Resistance (between terminals and case)	1000 MΩ or more
Fusing Characteristics	Fusing within 1 minute if the current is 200% of rated current.
Clearing Characteristics	Breaking voltage : 24 V
	Breaking current : 50 A

ORDERING INFORMATION

Type	Code	RV	Code	Rated current	Code	Rated current	Code	Package type	Special product code	Current
JAD	2402	24V	501	0.5 A	202	2.0 A	NA	φ180 ¹ J-ル	010	0.5 ~ 2.5 A
			801	0.8 A	252	2.5 A	ND	φ330 ¹ J-ル	013	3.15 A, 4.0 A
			102	1.0 A	322	3.15A				
			132	1.25A	402	4.0 A				
			162	1.6 A						

CATALOG NUMBERS AND RATING

February, 2011

Catalog number	Case size mm	Rated current A	Internal resistance mΩ	Voltage drop mV (Max.)	Rated voltage VDC	Breaking current A
JAD 2402 501 □□010	3.2 × 1.6	0.5	210	150	24	50
JAD 2402 801 □□010	3.2 × 1.6	0.8	106	150		
JAD 2402 102 □□010	3.2 × 1.6	1.0	76	130		
JAD 2402 132 □□010	3.2 × 1.6	1.25	56	120		
JAD 2402 162 □□010	3.2 × 1.6	1.6	49	120		
JAD 2402 202 □□010	3.2 × 1.6	2.0	38	120		
JAD 2402 252 □□010	3.2 × 1.6	2.5	33	120		
JAD 2402 322 □□013	3.2 × 1.6	3.15	23	120		
JAD 2402 402 □□013	3.2 × 1.6	4.0	20	120		

For the taping type, the packing code "NA" will be entered in □□.

DIMENSIONS

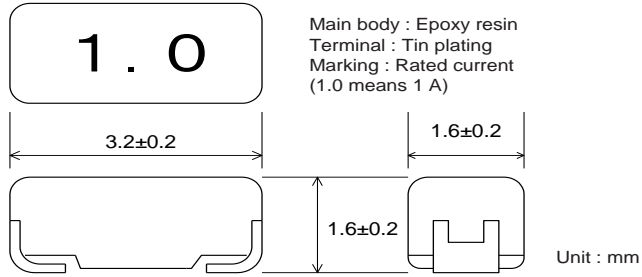

MARKING

Code	Rated current
0.5	0.50A
0.8	0.80A
1.0	1.00A
1.25	1.25A
1.6	1.60A
2.0	2.00A
2.5	2.50A
3.15	3.15A
4.0	4.00A

CONSTRUCTION

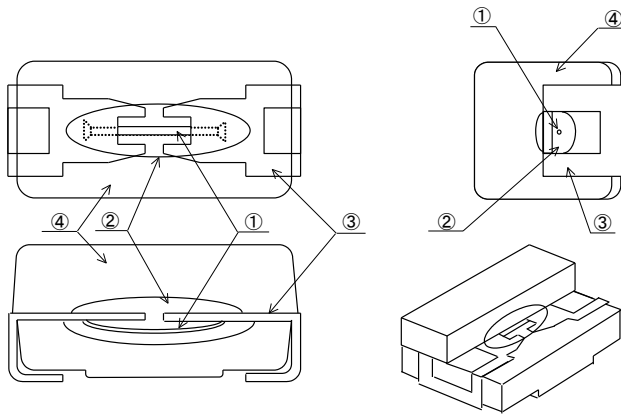

Number	Name	Material etc.
①	Fuse element	Lead alloy
②	Arc extinction material	Silicone resin
③	Terminal	Tin plating
④	Body	Epoxy resin

RECOMMENDED PAD DIMENSIONS

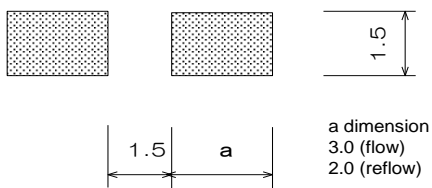

STANDARD TEST BODY

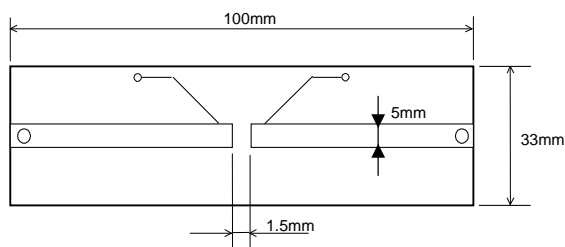

Glass epoxy body on one side
Board thickness : 1.6 mm
Copper layer :35μm

PERFORMANCE

No.	Item	Performance	Test method
1	Temperature rise	Temperature rise shall not exceed 70°C.	Apply rated current. (Ambient temperature : 10 ~ 30°C)
2	Current-carrying capacity	Shall not open within 1 hour.	Apply 100% of rated current at 70°C.
3	Voltage drop	Voltage drop is below the value specified in CATALOG NUMBERS AND RATING.	Apply rated current using 24 V power supply.
4	Fusing characteristics	Fusing within 1 min.	Apply 200% of rated current.
5	Insulation resistance	1000 MΩ or more	Insulation resistance between terminals and case
6	Electrode strength (Bending)	No mechanical damage. Shall meet the fusing characteristics. Variation of internal resistance should be less than ± 10%.	Board supporting width : 90 mm Bending speed : Approx. 0.5 mm/sec. Duration : 30 sec. Bending : 3 mm
7	Shear test	No mechanical damage. Shall meet the fusing characteristics. Variation of internal resistance should be less than ± 10%.	Applied force : 20 N (2.04 kgf) Duration : 10 sec
8	Substrate bending test	No mechanical damage. Shall meet the fusing characteristics. Variation of internal resistance should be less than ± 10%.	Supporting dimension : 1.2 mm Applied force : 10 N (1.02 kgf)
9	Solderability (Solder Wetting time)	Solder Wetting time : within 3sec.	Solder : Sn-3Ag-0.5Cu Temperature : 245 ± 3°C meniscograph method Solder : JISZ3282 H60A, H60S, H63A Temperature : 230 ± 2°C meniscograph method
10	Solderability (new uniform coating of solder)	The dipping surface of the terminals shall be covered more than 95% with new solder.	Solder : Sn-3Ag-0.5Cu Temperature : 245 ± 3°C Dipping : 3 sec. Solder : JISZ3282 H60A, H60S, H63A Temperature : 230 ± 2°C Dipping : 3 sec.
11	Resistance to soldering heat	Marking shall be legible. No mechanical damage. Shall meet the electric performance.	Dipping Preconditioning : 100 ~ 150°C, 60 sec. Temperature : 260 ± 5°C, 10 ± 1 sec. Reflow soldering Preconditioning : 1 ~ 2 min, 180°C or less Peak : 250 ± 5°C, 5 sec. Holding : 230 ~ 250°C, 20 ~ 40 sec. Cooling : more than 2 min. Manual soldering Iron edge temperature : higher than 350°C Duration : 3 ~ 4 sec.
12	Solvent resistance	Marking shall be legible. No mechanical damage. Shall meet the fusing characteristics. Variation of internal resistance should be less than ± 10%.	Dipping rinse Solvent : Isopropyl alcohol Duration : 90 sec
13	Vibration	No mechanical damage. Variation of internal resistance should be less than ± 10%.	Frequency range : 10 ~ 50 ~ 10 Hz/min Vibration amplitude : 1.5 mm Duration : 2 hours in each of XYZ directions (total : 6 hours)
14	Shock	No mechanical damage. Variation of internal resistance should be less than ± 10%.	Peak value : 490 m/s ² (50 G) Duration : 11 ms 6 aspects x 3 times (total : 18 times)
15	Thermal shock	No mechanical damage. Variation of internal resistance should be less than ± 10%.	-55 ± 3°C : 30 min. Room temperature : 2 ~ 3 min or less 125 ± 2°C : 30 min. Room temperature : 2 ~ 3 min or less Repeat above step for 10 cycles
16	Atomizing salt water	No mechanical damage. Variation of internal resistance should be less than ± 10%.	Temperature : 35 ± 2°C Concentration (weight ratio) : 5 ± 1% Duration : 24 hours
17	Moisture resistance	No mechanical damage. Variation of internal resistance should be less than ± 10%.	Temperature : 85 ± 3°C Humidity : 85 ± 3% RH Duration : 1000 ⁺⁴⁸ ₋₀ hours
18	Moisture resistance load	No mechanical damage. Variation of internal resistance should be less than ± 10%. JAD322 and 402 with SGU element shall be within %.	Temperature : 85 ± 3°C Humidity : 85 ± 3% RH Applied voltage : rated current × 78% Duration : 1000 ⁺⁴⁸ ₋₀ hours
19	Load life	No mechanical damage. Variation of internal resistance should be less than ± 10%. JAD322 and 402 with SGU element shall be within %.	Temperature : 85 ± 3°C Applied current : Rated current × 78% Duration : 1000 ⁺⁴⁸ ₋₀ hours
20	Stability	No mechanical damage. Variation of internal resistance should be less than ± 10%.	Temperature : 125 ± 3°C Duration : 1000 ⁺⁴⁸ ₋₀ hours

FUSING CHARACTERISTICS

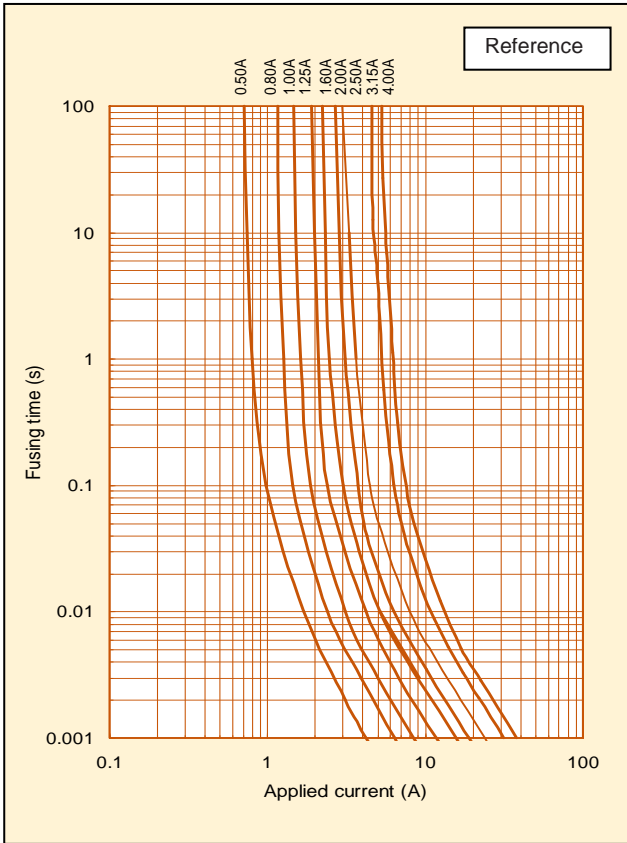

I²T CHARACTERISTICS

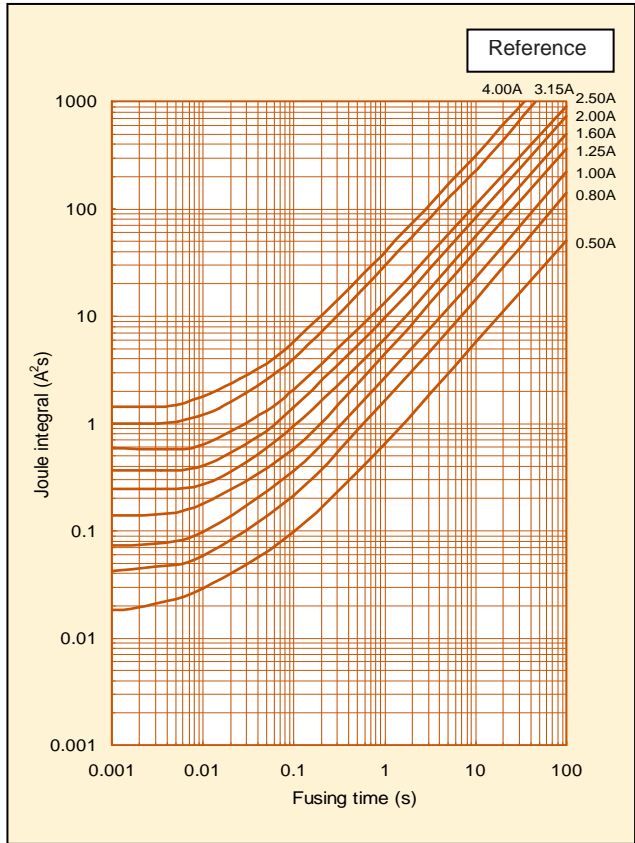

DISTRIBUTION OF FUSING CHARACTERISTICS

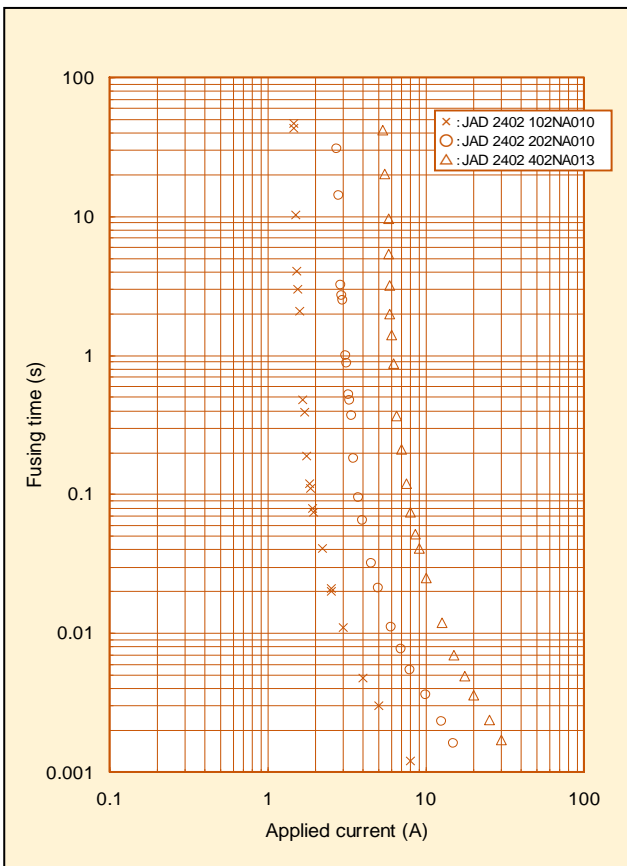

DISTRIBUTION OF FUSING TIME

JAD 2402 102 NA

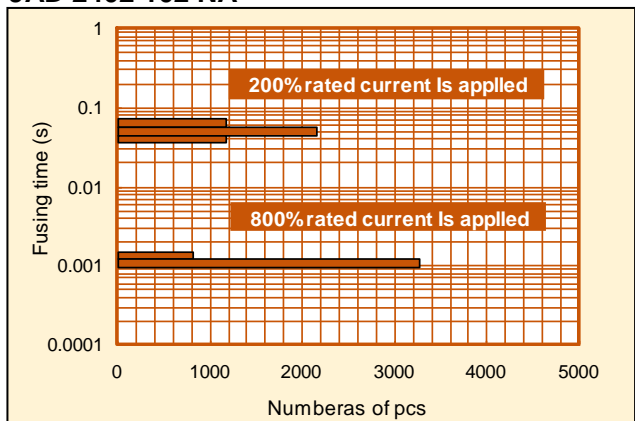

JAD 2402 202 NA

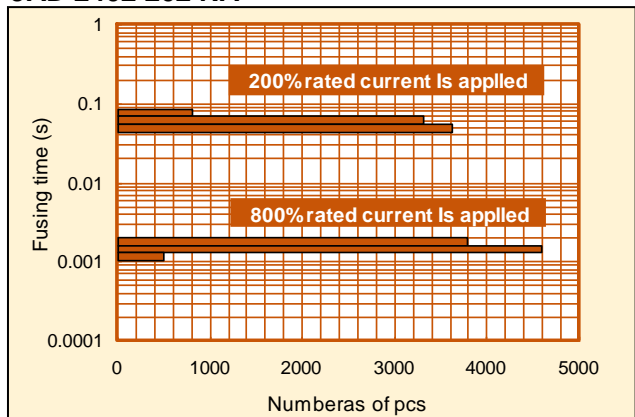

DETERMINATION OF RATED VALUE AND SELECTION OF MICRO FUSE (TYPE JAD)

Determine the rated value of circuit protection element, and select the correct circuit protection element for your circuit. If you select the correct circuit protection element, safety of your circuit can be ensured.

How to determine the rated value of the circuit protection element is described below :

■ Flow for fuse selection

1. Measurement of circuit values using actual device

Measure the circuit values, such as operating current of the circuit.

2. Calculation from operating current

From the obtained operating current and the category temperature, calculate the minimum rated value to determine the applicable fuse.

3. Calculation from overload current

From the obtained overload current, calculate the maximum rated value to determine the applicable fuse.

4. Calculation from inrush current

From the inrush current, calculate the minimum rated value to determine the applicable fuse.

5. Final determination of rated value

From the calculation results of steps 2 through 4, determine the rated value.

6. Operation check using actual device

After selecting the rating, confirm if the device works properly under the pre-determined conditions.

■ Fuse selection

1. Measurement of circuit values using actual device

Before determining the rated value of the fuse, preliminarily measure the following using the actual device.

1-1 Operating current

Using an oscilloscope or equivalents, measure the operating current of the circuit.

1-2 Overload current

Using an oscilloscope or equivalents, measure the overload current that needs to break the circuit.

1-3 Inrush current

Using an oscilloscope or equivalents, measure the inrush current of the circuit at power-on or power-off. In addition, determine the number of inrush current applied.

1-4 Category temperature

Measure the ambient temperature of the fuse circuit.

EXAMPLE TO SELECT RATINGS OF TYPE JAD

<Fuse selection>

Effective operating current : 1.2 A

Effective overload current : 6.0 A

Inrush current waveform : Fig. A

(Pulse width : 1 ms, Wave height : 10A)

Numbers to withstand inrush current : 100,000 times

Category temperature : 85°C

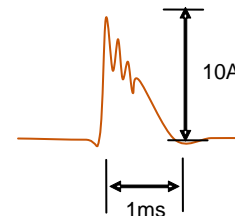

Fig. A : Inrush current waveform

2. Calculation from operating current

2-1 Measurement of operating current

Using an oscilloscope or equivalents, measure operating current (effective current) of the actual circuit.

Example : Effective operating current = 1.2 A

2-2 Derating

① Temperature derating factor

Using Fig. B, find the temperature derating factor correspond to the temperature.

② Rated derating factor

Rated derating factor = 0.78 (Constant irrespective of temperature)

Use Formula 1 to calculate the rated current of the fuse to be used for the circuit.

Rated current of fuse \geq Operating current / (① \times ②) ... Formula 1

Example: Category temperature = 85°C, Operating current = 1.2 A

① Temperature derating factor = 0.96 (Refer to Fig. B.)

② Rated derating factor = 0.78 (Constant irrespective of temperature)

Calculation using Formula 1 :

Rated current $\geq 1.2 / (0.96 \times 0.78) = 1.6$ A

The above calculation result shows that the fuse with rated current of 1.6 A or more should be selected for this circuit.

Type JAD, with rated current of 1.6 A or more can be selected.

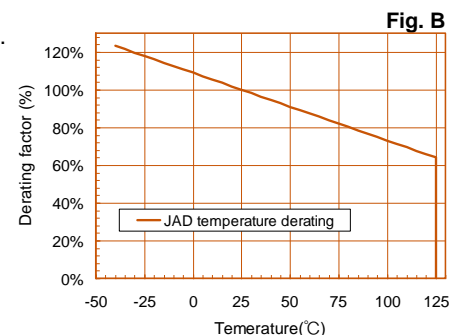

3. Calculation from overload current

3-1 Measurement of overload current

Using oscilloscope or equivalents, measure the overload current that needs to break the circuit.

Example : Effective overload current = 6.0 A

3-2 Calculation from overload current

Determine the rated current so that the overload current can be 2.0 times larger than the rated current.

Use Formula 2 to calculate the rated current of the fuse.

Rated current of fuse \leq Overload current / 2.0 ... Formula 2

Example : Overload current = 6.0 A

Use Formula 2 to calculate the rated current.

Rated current \leq 6.0 / 2.0 = 3.0 A

The above calculation result shows that the fuse with rated current of 3.0 A or less should be selected for this circuit.

Type JAD, with rated current of 2.5 A or less can be selected.

4. Calculation from inrush current

4-1 Measurement of inrush current waveform

Using an oscilloscope or equivalent, measure the waveform of the inrush current of the actual circuit.

4-2 Creation of approximate waveform

Generally, the waveform of inrush current is complicated. For this reason, create the approximate waveform of inrush current as shown on Fig. C to simplify calculation.

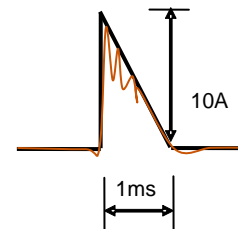

Fig. C : Inrush current waveform
Red line : Actual measurement waveform
Black line : Approximate waveform

4-3 Calculation of I^2t of inrush current

Calculate I^2t (Joule integral) of the approximate waveform.

The formula for this calculation depends on the approximate waveform.

Refer to Table A.

Example : Pulse applied = 1 ms, Peak value = 10 A,

Approximate waveform = Triangular wave

Since the approximate waveform is a triangular wave, use the following formula for calculation.

I^2t of rush current = $1 / 3 \times I_m^2 \times t$... Formula 3

(I_m : Peak value, t : Pulse applying time)

Use Formula 3 to calculate I^2t of the rush current :

$I^2t = 1 / 3 \times 10 \times 10 \times 0.001 = 0.033 (A^2s)$

JOULE-INTEGRAL VALUES FOR EACH WAVEFORM

Table A

Name	Waveform	I^2t	Name	Waveform	I^2t
Sine wave (1 cycle)		$\frac{1}{2} I_m^2 t$	Trapezoidal wave		$\frac{1}{3} I_m^2 t_1 + I_m^2 (t_2 - t_1) + \frac{1}{3} I_m^2 (t_3 - t_2)$
Sine wave (half cycle)		$\frac{1}{2} I_m^2 t$	Various wave 1		$I_1 I_2 t + \frac{1}{3} (I_1 - I_2)^2 t$
Triangular wave		$\frac{1}{3} I_m^2 t$	Various wave 2		$\frac{1}{3} I_1^2 t_1 + (I_1 I_2 + \frac{1}{3} (I_1 - I_2)^2) (t_2 - t_1) + \frac{1}{3} I_2^2 (t_3 - t_2)$
Rectangular wave		$I_m^2 t$	Charge/discharge waveform		$\frac{1}{2} I_m^2 t$

* Following formula is generally used for calculation of I^2t as $i(t)$ equal to current.

$$I^2t = \int_0^t i^2(t) dt$$

4-4 Search of load ratio

- ① Set up the number of cycles to withstand. (generally 100,000 times)
- ② Obtain the load ratio from Pulse resistance characteristics. (Fig. D)

Example : 100,000 times is required against inrush current applied.

The load ratio is 20% or less from Fig. D.

PULSE RESISTANCE CHARACTERISTICS

Fig. D

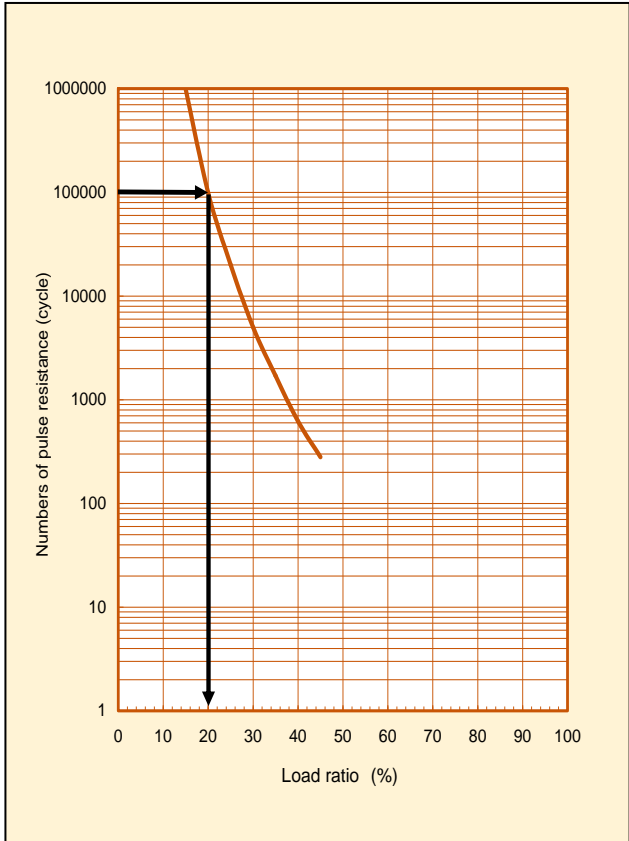

4-5 Calculation from Joule integral and load ratio

Use Formula 4 to calculate the standard I^2t for the fuse to be used.

Standard I^2t of fuse > (I^2t of inrush current / load ratio)
Formula 4

Example : I^2t of pulse = 0.033 A^2s , Pulse applied = 1 ms,
 Required load ratio = 20%

From Formula 4,
 Standard I^2t of fuse > 0.033 / 0.2 = 0.17 (A^2s)
 The standard I^2t of the fuse should be 0.17 (A^2s) or more.

Since the rush pulse applied is 1 ms, obtain the intersection of 1 ms (horizontal axis) and 0.17 A^2s (vertical axis) from Fig. E (refer to the arrow shown in Fig.E).

Select a fuse whose curve is above the intersection. Type JAD, with rated current of 1.6 A or more should be selected.

5. Final determination of rated value

Determine the rated current of the micro fuse. The rated current should meet all the calculation results.

Example : 1.6A, 2.0 A and 2.5A meet the all requirement.

6. Operation check using actual device

After selecting the rating, confirm if the device works properly under the pre-determined conditions.

JOULE INTEGRAL VS. FUSING TIME

Fig. E

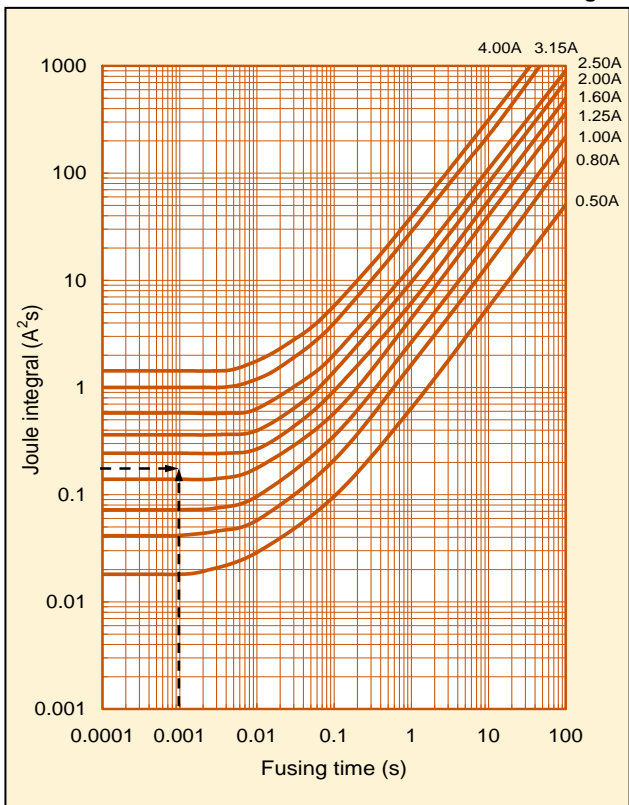



Application Notes for Micro Fuse

1. Circuit Design

Micro Fuse should be designated only after confirming operating conditions and the Micro Fuse performance characteristics.

When determining the rated current, be sure to observe the following items :

- (1) Micro Fuse should always be operated below the rated current (the value considered in the temperature derating rate) and voltage specifications. According to item 2,2-2 in page 5.
- (2) Micro Fuse should always be operated below the rated voltage.
- (3) Micro Fuse should be selected with correct rated value to be fused at overload current.
- (4) When Micro Fuse are used in inrush current applications, please confirm sufficiently inrush resistance of Micro Fuse.
- (5) Please do not apply the current exceeding the breaking current to Micro Fuse.
- (6) Use Micro Fuse under the condition of category temperature.
- (7) Micro Fuse should not be used in the primary power source.

Micro Fuse should be selected by determining the operating conditions that will occur after final assembly, or estimating potential abnormalities through cycle testing.

2. Assembly and Mounting

During the entire assembly process, observe Micro Fuse body temperature and the heating time specified in the performance table. In addition, observe the following items :

- (1) Mounting and adjusting with soldering irons are not recommendable since temperature and time control is difficult.
In case of emergency for using soldering irons, be sure to observe the conditions specified in the performance table.
- (2) Micro Fuse body should not have direct contact with a soldering iron.
- (3) Once Micro Fuse mounted on the board, they should never be remounted on boards or substrates.
- (4) During mounting, be careful not to apply any excessive mechanical stresses to the Micro Fuse.

3. Solvents

For cleaning of Micro Fuse, immersion in isopropyl alcohol for 90 seconds (at 20 ~ 30°C liquid temp.) will not be damaged.

If organic solvents (Pine Alpha™, Techno Care™, Clean Through™, etc.) will be applied to the Micro Fuse, be sure to preliminarily check that the solvent will not damage the Micro Fuse.

4. Ultrasonic Cleaning

Ultrasonic cleaning is not recommended for Micro Fuse. This may cause damage to the Micro Fuse such as broken terminals which results in electrical characteristics effects, etc. depending on the conditions.

If Ultrasonic cleaning process must be used, please evaluate the effects sufficiently before use.

5. Caution During Usage

- (1) Micro Fuse with electricity should never be touched. Micro Fuse with electricity may cause burning due to the Micro Fuse high temperature. Also, in case of touching Micro Fuse without electricity, please check the safety temperature of Micro Fuse.
- (2) Protective eyeglasses should always be worn when performing fusing tests. However, there is a fear that Micro Fuse will explode during test. During fusing tests, please cover particles not to fly outward from the board or testing fixture. Caution is necessary during usage at all times.

6. Environmental Conditions

- (1) Micro Fuse should not be operated in acid or alkali corrosive atmosphere.
- (2) Micro Fuse should not be vibrated, shocked, or pressed excessively.
- (3) Micro Fuse should not be operated in a flammable or explosive atmosphere.
- (4) After mounting Micro Fuse on a board, covering Fuses with resin may affect to the electric characteristics of the Micro Fuse. Please be sure to evaluate it in advance.

7. Emergency

In case of fire, smoking, or offensive odor during operation, please cut off the power in the circuit or pull the plug out.

8. Storage

- (1) Micro Fuse should be stored at room temperature (-10°C ~ +40°C) without direct sunlight but not in corrosive atmosphere such as H₂S (hydrogen sulfide) or SO₂ (sulfur dioxide). Direct sunlight may cause decolorization and deformation of the exterior and taping. Also, there is a fear that solderability will be remarkably lower in high humidity.
- (2) If the products are stored for an extended period of time, please contact Matsuo Sales Department for recommendation. The longer storage term causes packages and tapings to worsen. If the products are stored for longer term, please contact Matsuo Sales Department for advice.
- (3) The products in taping, package, or box should not be given any kind of physical pressure. Deformation of taping or package may affect automatic mounting.

9. Disposal

When Micro Fuse are disposed of as waste or "scrap", they should be treated as "industrial waste". Micro Fuse contain various kinds of metals and resins.

10. Samples

Micro Fuse received as samples should not be used in any products or devices in the market. Samples are provided for a particular purpose such as configuration, confirmation of electrical characteristics, etc.



MATSUO ELECTRIC CO., LTD.

Please feel free to ask our sales department for more information on the Micro Fuse.

Overseas Sales Dep. 5-3,3-Chome,Sennari-cho,Toyonaka-shi,Osaka 561-8558,Japan Tel : 06-6332-0883 Fax : 06-6332-0920
Head office 5-3,3-Chome,Sennari-cho,Toyonaka-shi,Osaka 561-8558,Japan Tel : 06-6332-0871 Fax : 06-6331-1386
URL <http://www.ncc-matsuo.co.jp/>

Specifications on this catalog are subject to change without prior notice. Please inquire of our Sales Department to confirm specifications prior to use.