



\* Standard

# SPECIFICATION [SMDB05V]

SSC			Customer
Drawn by	Checked by	Approved by	Approved by
S.W.TAE	S.R.RYU	H.J.Hong	
10/15	10/15	10/15	

Rev. 00

October, 2012

www.acrich.com

Document No. : QP-7-07-18 (Rev.00) 공통\_음



# Contents

1.	Description	-----	4
2.	Absolute Maximum Ratings	-----	5
3.	Electro-Optical Characteristics	-----	5
4.	Characteristic Diagram	-----	6
5.	Reliability Test	-----	9
6.	Color & Binning	-----	10
7.	Outline Dimension	-----	14
8.	Material List	-----	15
9.	Packing	-----	16
10.	Soldering	-----	18
11.	Precaution for use	-----	19



# SMDB05V

## 1. Description

- 1-chip in one package
- SMT solderability
- Own patent reserved
- RoHS Compliant
- Low Thermal Resistance
- Pb-free Reflow Soldering application
- SMDB05V is very useful side view LED in back light unit application



## SMDB05V

### Features

- 3.8 (W) X 1.0 (D) X 0.8 (T) mm
- Side View LED of Reflector type

### Applications

- Flat Backlighting (LCD, Display)
- Mobile Phone, Camera, PDA, Notebook
- Coupling into Light Guide Panel
- AV systems



## 2. Absolute maximum ratings

(T<sub>a</sub> = 25°C)

Parameter	Symbol	Value	Unit
Power Dissipation	$P_d^{*1}$	90	mW
DC Forward Current	$I_F$	30	mA
Peak Forward Current	$I_{FM}^{*2}$	100	mA
Reverse Voltage	$V_R$	5	V
Operating Temperature	$T_{opr}$	-30 ~ +85	°C
Storage Temperature	$T_{stg}$	-40 ~ +100	°C
Junction Temperature	$T_j max$	105	°C

\*1 Care is to be taken that power dissipation does not exceed the absolute maximum rating of the product.

\*2  $I_{FM}$  was measured at  $T_w \leq 0.1$  msec of pulse width and  $D \leq 1/10$  of duty ratio.

## 3. Electro-Optical characteristics

(T<sub>a</sub> = 25°C)

Parameter		Symbol	Condition	Min	Typ	Max	Unit
Forward Voltage* <sup>1</sup>	Rank Z26	$V_F$	$I_F = 20$ mA	2.6	-	2.8	V
	Rank Z28			2.8	-	3.0	
Reverse Voltage		$V_R$	$I_R = 3$ μA	0.6		0.9	V
Luminous Intensity* <sup>2</sup>	Rank S21H	$I_V$	$I_F = 20$ mA	2100	-	2200	mcd
	Rank S22H			2200	-	2300	
	Rank S23H			2300	-	2400	
	Rank S24H			2400	-	2500	
	Rank S25H			2500	-	2600	
	Rank S26H			2600	-	2700	
	Rank S27H			2700	-	2800	
	Rank S28H			2800	-	2900	
Rank S29H	2900	-	3000				
Viewing Angle * <sup>3</sup>		$2\theta_{1/2}$	$I_F = 20$ mA	120			deg.
Thermal Resistance		$R_{th(j-s)}$ * <sup>4</sup>		140			°C/W
Electro-Static Discharge Threshold		ESD	(HBM)	±5,000			V

\*1 Forward voltage measurement allowance is ±0.1V

\*2 The luminous intensity  $I_V$  is measured at the peak of the spatial pattern which may not be aligned with the mechanical axis of the LED package. Luminous Intensity Measurement allowance is ±10%.

\*3  $2\theta_{1/2}$  is the off-axis where the luminous intensity is 1/2 of the peak intensity.

Rev. 00

October, 2012

www.acrich.com

[Note] All measurements were made under the standardized environment of SSC.

### 4. Characteristic Diagram

Forward Current vs. Forward Voltage

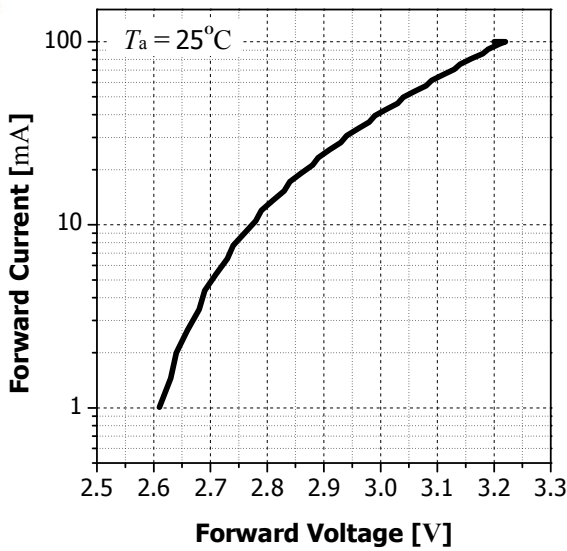

Intensity vs. Forward Current

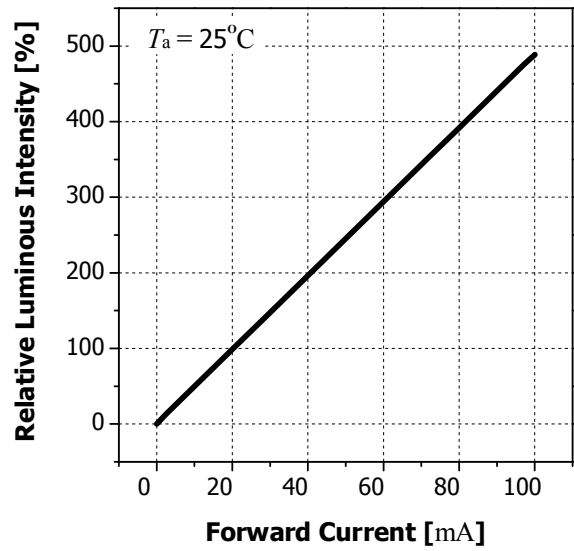

Color Coordinate vs. Forward Current

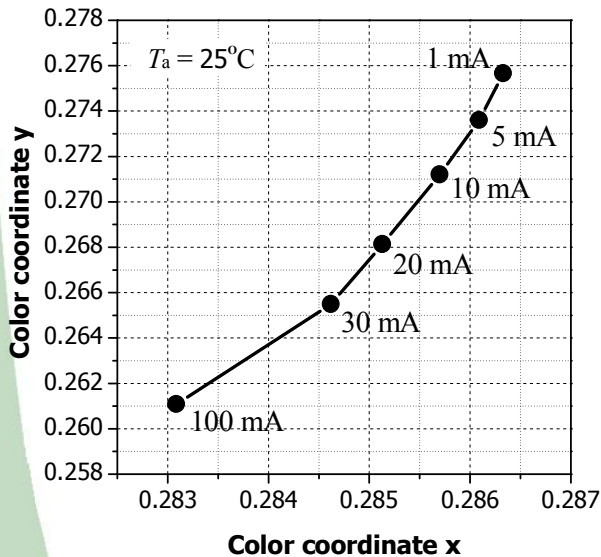

Radiation Diagram

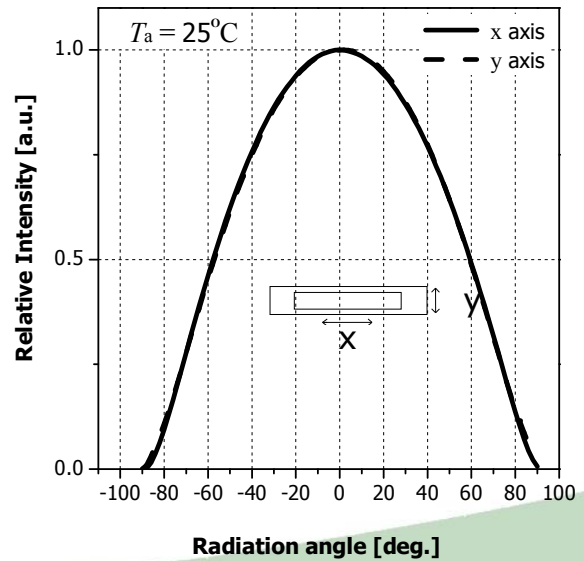

Forward Voltage vs. Ambient Temperature

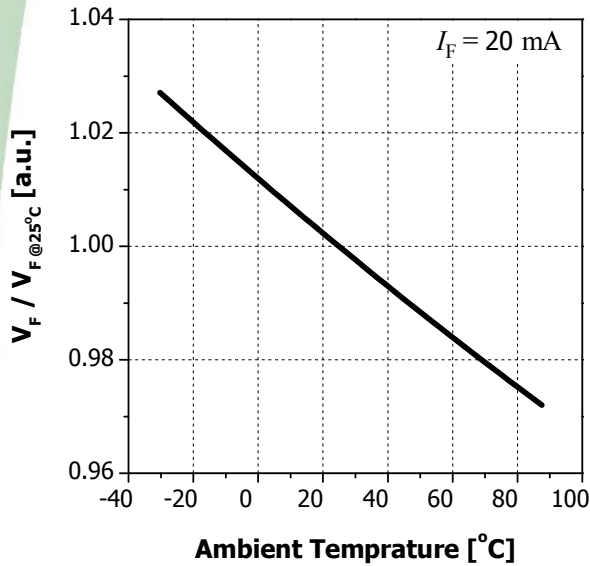

Relative Luminosity vs. Ambient Temperature

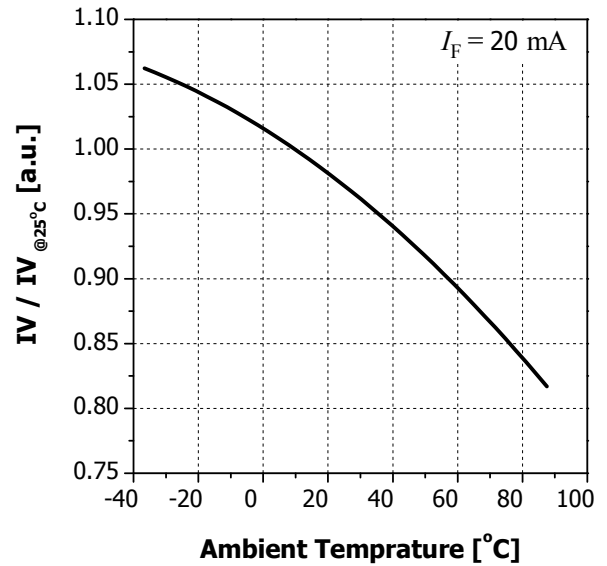

Color Coordinate vs. Ambient Temperature

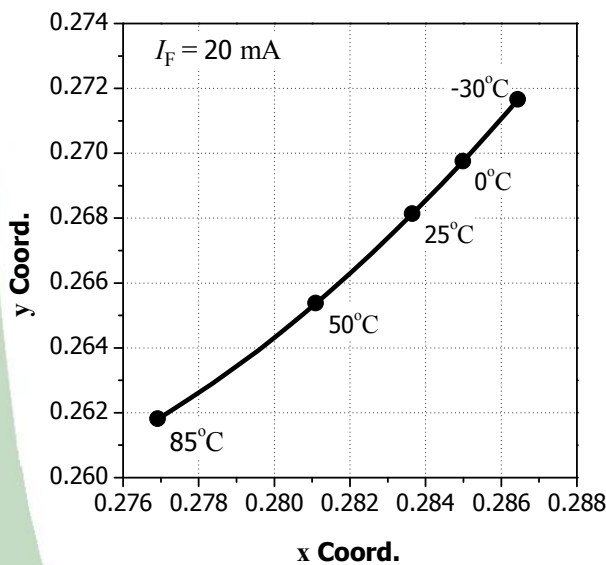

Spectrum

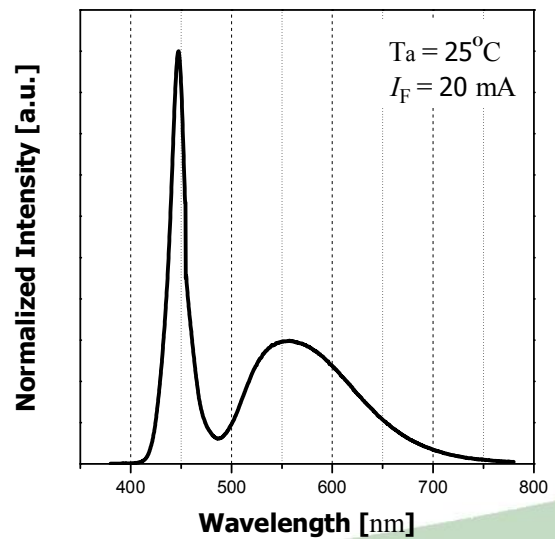

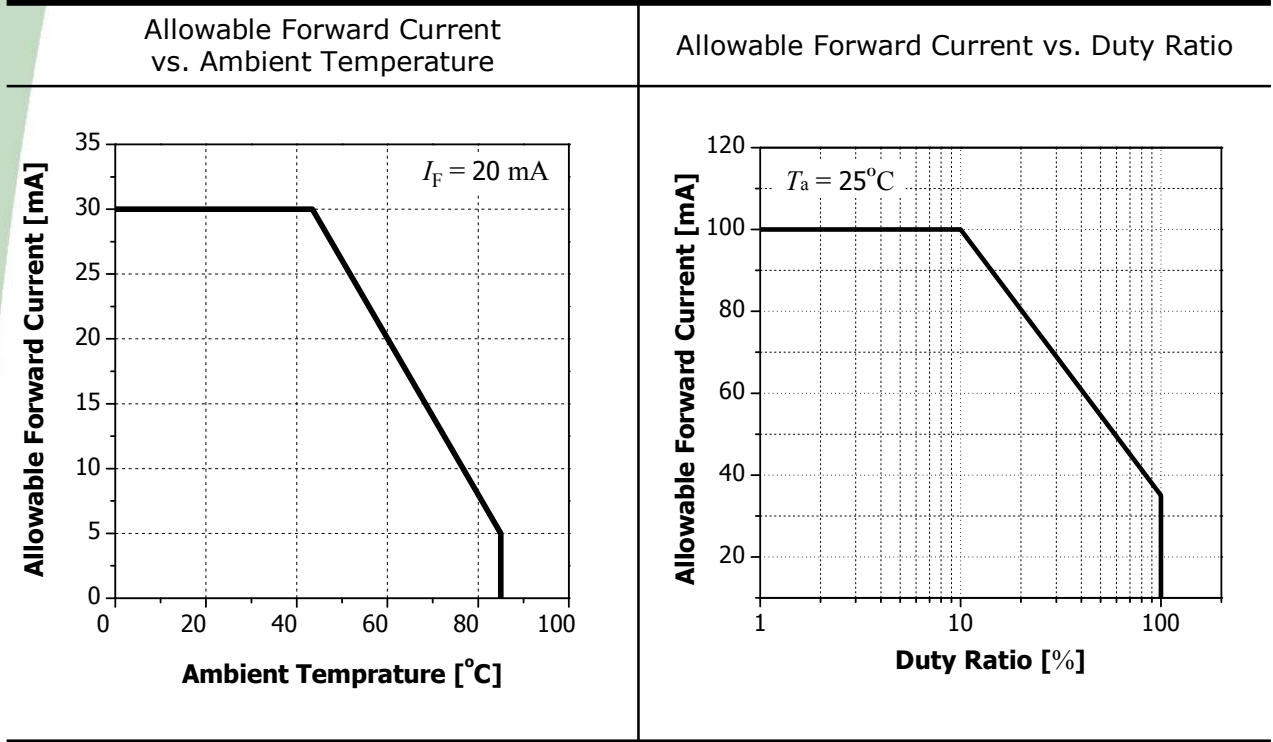



## 5. Reliability Test

### \* TEST ITEMS AND RESULTS

Item	Reference	Test Condition	Duration / Cycle	Number of Damage
Life Test	-	$T_a = 25^{\circ}\text{C}, I_F = 20\text{mA}$	1,000 Hours	0/20
High Temperature Life Test	-	$T_a = 85^{\circ}\text{C}, I_F = 5\text{mA}$	1,000 Hours	0/20
Low Temperature Life Test	-	$T_a = -30^{\circ}\text{C}, I_F = 20\text{mA}$	1,000 Hours	0/20
High Humidity Heat Life Test	JEITA ED-4701 100 102	$T_a = 60^{\circ}\text{C}, \text{RH} = 90\%, I_F = 20\text{mA}$	500 Hours	0/20
High Temperature Storage	JEITA ED-4701 200 201	$T_a = 100^{\circ}\text{C}$	1,000 Hours	0/20
Low Temperature Storage	JEITA ED-4701 200 202	$T_a = -40^{\circ}\text{C}$	1,000 Hours	0/20
Temperature Cycle	JEITA ED-4701 100 105	$-40^{\circ}\text{C} \sim 25^{\circ}\text{C} \sim 100^{\circ}\text{C} \sim 25^{\circ}\text{C}$ (30min) (5min) (30min) (5min)	100 cycle	0/50

### \* Criteria for Judging the Damage

Item	Symbol	Condition	Criteria for Judgement	
			MIN	MAX
Forward Voltage	$V_F$	$I_F = 20\text{mA}$	-	I.V. *1 × 1.2
Luminous Intensity	$I_V$	$I_F = 20\text{mA}$	I.V. × 0.7	-

Note : \*1 I.V. : Initial Value  
\*2 U.S.L : Upper Standard Level

Rev. 00

October, 2012

www.acrich.com

## 6. Color & Binning

### \* CIE Chromaticity Diagram

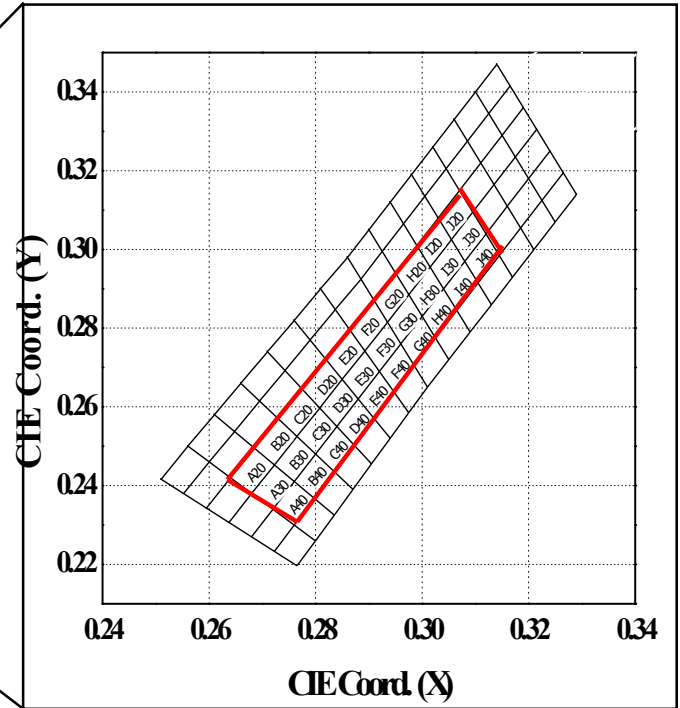
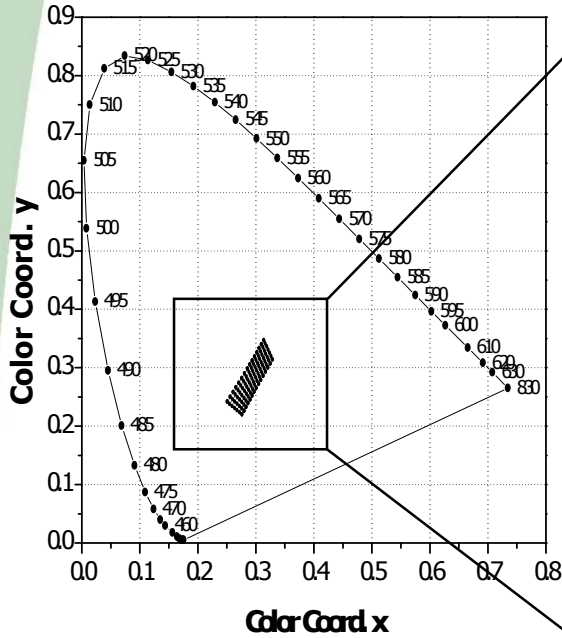

### \* Color Rank

A20		B20		C20		D20	
x	y	x	y	x	y	x	y
0.264	0.242	0.269	0.250	0.273	0.257	0.278	0.265
0.269	0.250	0.273	0.257	0.278	0.265	0.282	0.272
0.272	0.245	0.277	0.253	0.281	0.260	0.285	0.267
0.268	0.238	0.272	0.245	0.277	0.253	0.281	0.260

E20		F20		G20		H20	
x	y	x	y	x	y	x	y
0.282	0.272	0.287	0.280	0.291	0.287	0.295	0.294
0.287	0.280	0.291	0.287	0.295	0.294	0.299	0.301
0.289	0.274	0.294	0.282	0.298	0.289	0.302	0.296
0.285	0.267	0.289	0.274	0.294	0.282	0.298	0.289

\* Measurement Uncertainty of the Color Coordinates is  $\pm 0.007$



I20		J20		A30		B30	
x	y	x	y	x	y	x	y
0.299	0.301	0.303	0.308	0.268	0.238	0.272	0.245
0.303	0.308	0.307	0.315	0.272	0.245	0.277	0.253
0.306	0.303	0.310	0.310	0.276	0.241	0.280	0.248
0.302	0.296	0.306	0.303	0.272	0.234	0.276	0.241

C30		D30		E30		F30	
x	y	x	y	x	y	x	y
0.277	0.253	0.281	0.260	0.285	0.267	0.289	0.274
0.281	0.260	0.285	0.267	0.289	0.274	0.294	0.282
0.284	0.255	0.288	0.262	0.292	0.269	0.296	0.276
0.280	0.248	0.284	0.255	0.288	0.262	0.292	0.269

G30		H30		I30		J30	
x	y	x	y	x	y	x	y
0.294	0.282	0.298	0.289	0.302	0.296	0.306	0.303
0.298	0.289	0.302	0.296	0.306	0.303	0.310	0.310
0.300	0.283	0.304	0.290	0.308	0.297	0.312	0.304
0.296	0.276	0.300	0.283	0.304	0.290	0.308	0.297

A40		B40		C40		D40	
x	y	x	y	x	y	x	y
0.272	0.234	0.276	0.241	0.280	0.248	0.284	0.255
0.276	0.241	0.280	0.248	0.284	0.255	0.288	0.262
0.280	0.237	0.284	0.244	0.287	0.250	0.291	0.257
0.276	0.230	0.280	0.237	0.284	0.244	0.287	0.250

\* Measurement Uncertainty of the Color Coordinates is  $\pm 0.007$



E40		F40		G40		H40	
x	y	x	y	x	y	x	y
0.288	0.262	0.292	0.269	0.296	0.276	0.300	0.283
0.292	0.269	0.296	0.276	0.300	0.283	0.304	0.290
0.295	0.264	0.299	0.271	0.303	0.278	0.307	0.285
0.291	0.257	0.295	0.264	0.299	0.271	0.303	0.278

I40		J40	
x	y	x	y
0.304	0.290	0.308	0.297
0.308	0.297	0.312	0.304
0.311	0.292	0.315	0.299
0.307	0.285	0.311	0.292

\* Measurement Uncertainty of the Color Coordinates is  $\pm 0.007$

\* Bin Code description

▷ Part Number : SMDB05V

Bin Code		
Luminous Intensity	CIE	Forward Voltage
S22H	E20	Z28

Luminous Intensity (mcd) @ $I_F = 20\text{mA}$		
Bin Code	Min.	Max.
S21H	2100	2200
S22H	2200	2300
S23H	2300	2400
S24H	2400	2500
S25H	2500	2600
S26H	2600	2700
S27H	2700	2800
S28H	2800	2900
S29H	2900	3000

Color Rank @ $I_F = 20\text{mA}$		
2	3	4
A20	A30	A40
B20	B30	B40
C20	C30	C40
D20	D30	D40
E20	E30	E40
F20	F30	F40
G20	G30	G40
H20	H30	H40
I20	I30	I40
J20	J30	J40

Forward Voltage (V) @ $I_F = 20\text{mA}$		
Bin Code	Min.	Max.
Z26	2.6	2.8
Z28	2.8	3.0

Available ranks

7. Outline Dimension

( Tolerance:  $\pm 0.1$ , Unit: mm )

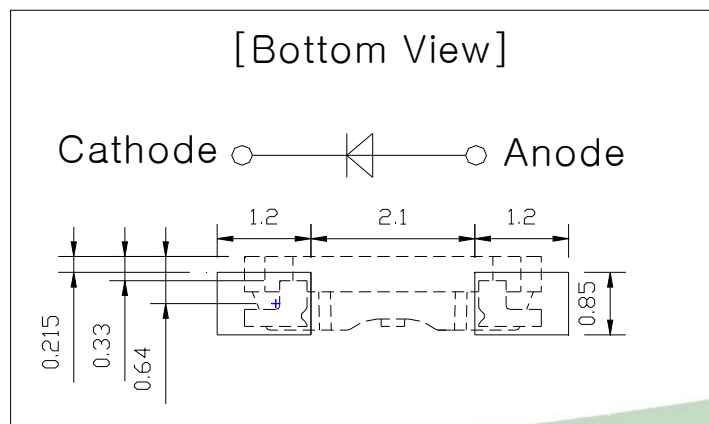
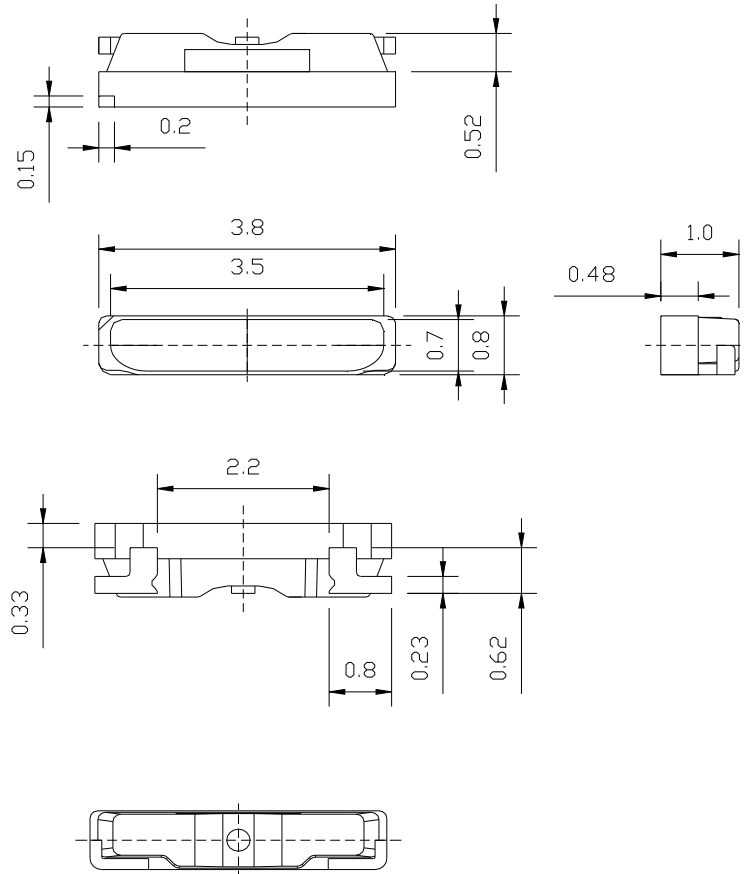

<Recommended solder Pattern>

Rev. 00

October, 2012

www.acrich.com

8. Material

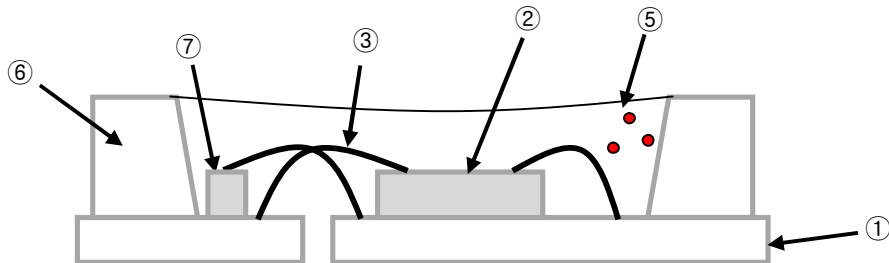

No.	LIST	MATERIAL
①	FRAME	COPPER FRAME (SILVER PLATED)
②	LED CHIP	GaN ON SAPPHIRE
③	WIRE	GOLD WIRE
④	ENCAPSULATION	SILICONE
⑤	PHOSPHOR	YAG
⑥	PACKAGE	HEAT-RESISTANT POLYMER
⑦	ZENER	Si

## 9. Packing

### 1) Reel & Carrier

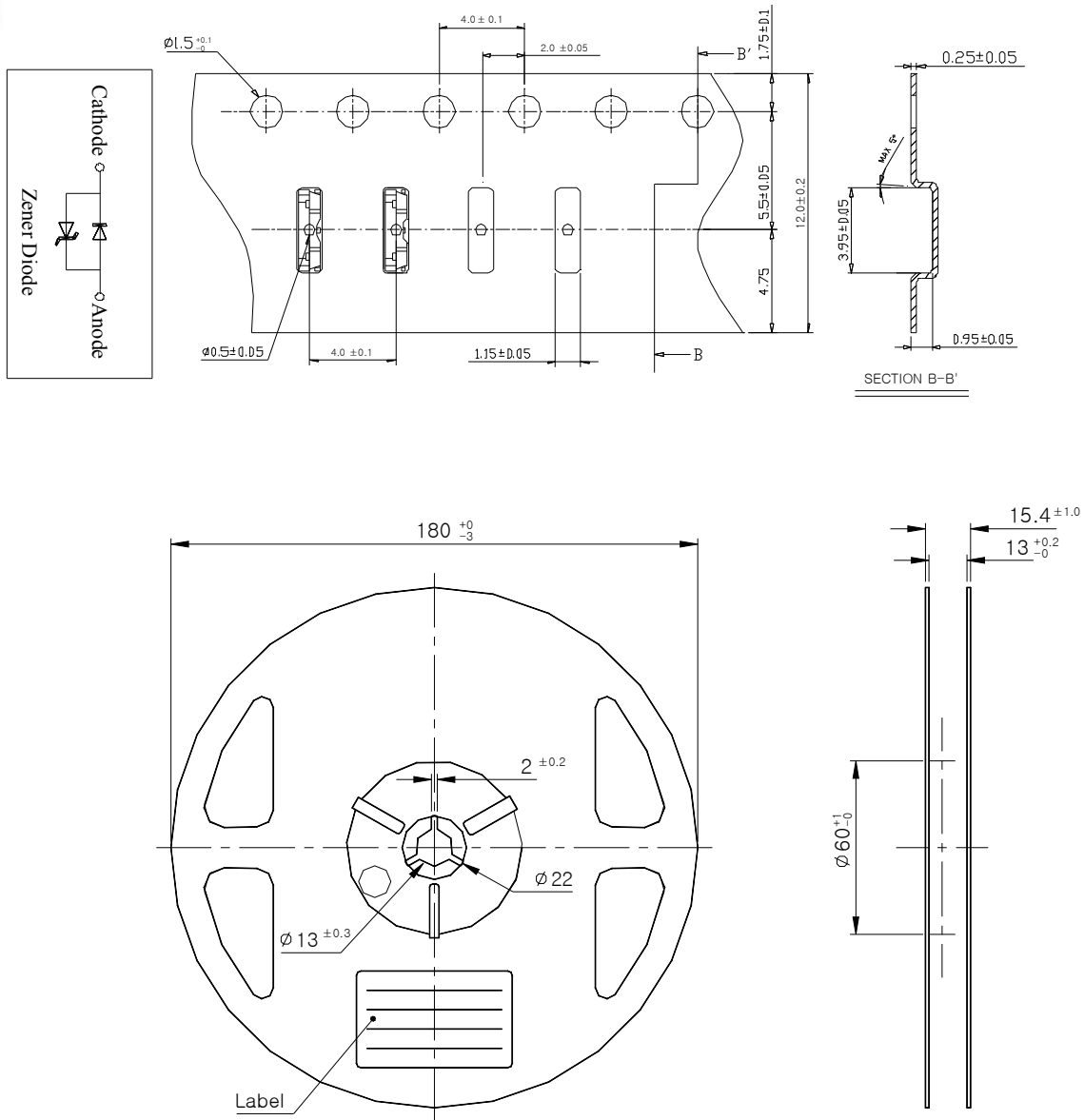

( Tolerance:  $\pm 0.2$ , Unit: mm )

- (1) Quantity : 3500pcs/Reel
- (2) Cumulative Tolerance : Cumulative Tolerance/10 pitches to be  $\pm 0.2$ mm
- (3) Adhesion Strength of Cover Tape : Adhesion strength to be 0.1-0.7N when the cover tape is turned off from the carrier tape at the angle of  $10^\circ$  to the carrier tape
- (4) Package : P/N, Manufacturing data Code No. and quantity to be indicated on a damp proof Package

Rev.00

October, 2012

www.acrich.com



## 2) Reel Packing Structure

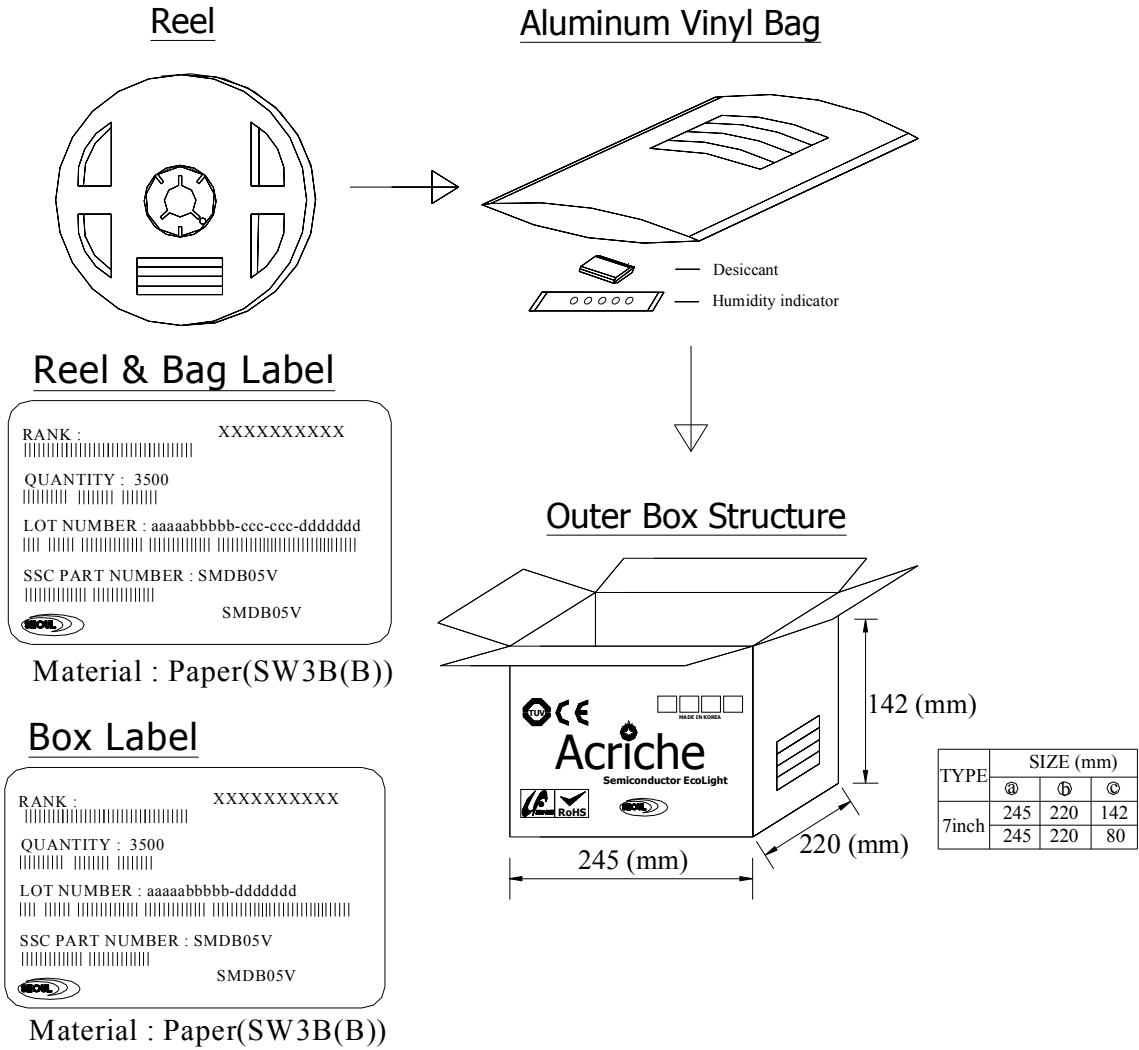

## 3) Lot Number

The lot number is composed of the following characters  
 aaaaabbbb-ccc-ccc-ddddddd

Symbol	Meaning	Example
aaaa	THE DATE	09A23 (Year : 09, A : Month, 23 : day)
bbbb	SSC's Number	Ex) S0017 0001~9999 allowance
ccc-ccc	Order of Taping	014-001
ddddddd	SSC's Number	7300024(Automatic)

Rev. 00

October, 2012

www.acrich.com

## 10. Soldering

### (1) Lead Solder

Lead Free Solder	
Pre-heat	120~150℃
Pre-heat time	120 sec. Max.
Peak-Temperature	240℃ Max.
Soldering time Condition	10 sec. Max.

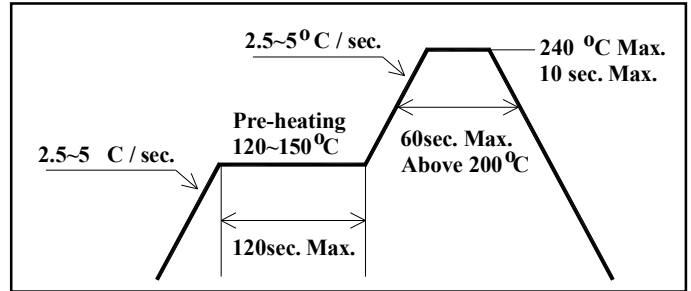

### (2) Lead-Free Solder

Lead Free Solder	
Pre-heat	150~200℃
Pre-heat time	120 sec. Max.
Peak-Temperature	260℃ Max.
Soldering time Condition	10 sec. Max.

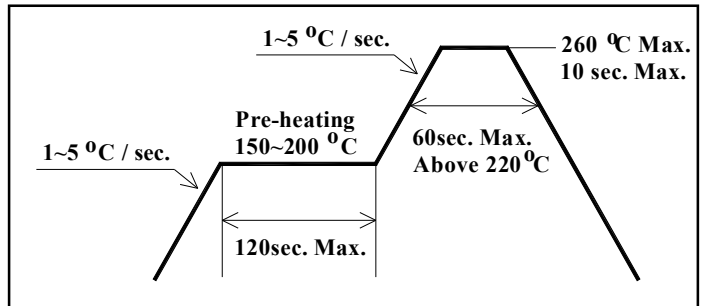

### (3) Hand Soldering conditions

Not more than 3 seconds @MAX 350℃, under Soldering iron.

Note : In case that the soldered products are reused in soldering process, we don't guarantee the products.

Rev. 00

October, 2012

www.acrich.com

## 11. Precaution for use

### (1) Storage conditions

- Keep the product in a dry box or a desiccator with a desiccant in order to prevent moisture absorption.
  - a. Keep it at a temperature in the range from 5°C to 30°C and at a humidity of less than 50% RH.
- The product should be kept within a year.

### (2) After opening the package .

- When soldering, this could result in a decrease of the photoelectric effect or light intensity.
  - a. Soldering should be done right after mounting the product.
  - b. Keep the temperature in the range from 5°C to 30°C and the humidity at less than 60%.
- Soldering should be done within 7 days after opening the desiccant package. If the product has been exposed for more than 7 days after opening the package or the indicating color of the desiccator changes, the product must be baked at a temperature between  $65 \pm 5^\circ\text{C}$  for less than 24 hours.
- An unused and unsealed product should be repacked in a desiccant package and kept sealed in a dry atmosphere.
- Stored at a humidity of less than 10% RH.

### (3) Precautions for use

- Any external mechanical force or excessive vibration should not be applied to the product during cooling after soldering, and it is preferable to avoid rapid cooling.
- The product should not be mounted on a distorted part of PCB.
- Gloves or wrist bands for ESD(Electric Static Discharge) should be wore in order to prevent ESD and surge damage, and all devices and equipments must be grounded to the earth.

### (4) Miscellaneous

- Radiation resistance is not considered.
- When cleaning the product, any kind of fluid such as water, oil and organic solvent must not be used and IPA(Isopropyl Alcohol) must be used.
- When using the product, operating current should be settled in consideration of the maximum ambient temperature.
- Its appearance or specification for improvement is subject to change without notice.