

High Efficiency LED, \varnothing 5 mm Tinted Non-Diffused Package

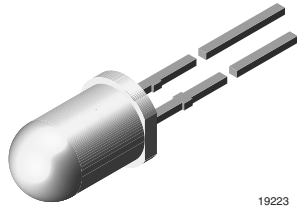

19223

DESCRIPTION

The TLH.52.. series was developed for standard applications like general indicating and lighting purposes.

It is housed in a 5 mm tinted non-diffused plastic package. The small viewing angle of these devices provides a high brightness.

Several selection types with different luminous intensities are offered. All LEDs are categorized in luminous intensity groups. The green and yellow LEDs are categorized additionally in wavelength groups.

That allows users to assemble LEDs with uniform appearance.

FEATURES

- Choice of three bright colors
- Standard T-1 $\frac{3}{4}$ package
- Small mechanical tolerances
- Suitable for DC and high peak current
- Small viewing angle
- Luminous intensity categorized
- Yellow and green color categorized
- TLH.52.. with stand-offs
- Lead (Pb)-free device



APPLICATIONS

- Status lights
- OFF/ON indicator
- Background illumination
- Readout lights
- Maintenance lights
- Legend light

PRODUCT GROUP AND PACKAGE DATA

- Product group: LED
- Package: 5 mm
- Product series: standard
- Angle of half intensity: $\pm 14^\circ$

PARTS TABLE		
PART	COLOR, LUMINOUS INTENSITY	TECHNOLOGY
TLHR5200	Red, $I_V = 20$ mcd (typ.)	GaAsP on GaP
TLHR5201	Red, $I_V = 30$ mcd (typ.)	GaAsP on GaP
TLHR5205	Red, $I_V = 40$ mcd (typ.)	GaAsP on GaP
TLHY5200	Yellow, $I_V = 30$ mcd (typ.)	GaAsP on GaP
TLHY5201	Yellow, $I_V = 40$ mcd (typ.)	GaAsP on GaP
TLHY5205	Yellow, $I_V = 50$ mcd (typ.)	GaAsP on GaP
TLHG5200	Green, $I_V = 30$ mcd (typ.)	GaP on GaP
TLHG5201	Green, $I_V = 40$ mcd (typ.)	GaP on GaP
TLHG5205	Green, $I_V = 50$ mcd (typ.)	GaP on GaP



ABSOLUTE MAXIMUM RATINGS¹⁾ TLHR52.. TLHY52.. , TLHG52..				
PARAMETER	TEST CONDITION	SYMBOL	VALUE	UNIT
Reverse voltage		V_R	6	V
DC Forward current	$T_{amb} \leq 65\text{ }^\circ\text{C}$	I_F	30	mA
Surge forward current	$t_p \leq 10\text{ }\mu\text{s}$	I_{FSM}	1	A
Power dissipation	$T_{amb} \leq 65\text{ }^\circ\text{C}$	P_V	100	mW
Junction temperature		T_j	100	$^\circ\text{C}$
Operating temperature range		T_{amb}	- 20 to + 100	$^\circ\text{C}$
Storage temperature range		T_{stg}	- 55 to + 100	$^\circ\text{C}$
Soldering temperature	$t \leq 5\text{ s, 2 mm from body}$	T_{sd}	260	$^\circ\text{C}$
Thermal resistance junction/ambient		R_{thJA}	350	K/W

Note:

¹⁾ $T_{amb} = 25\text{ }^\circ\text{C}$, unless otherwise specified

Optical and Electrical Characteristics¹⁾ TLHR52..., Red							
PARAMETER	TEST CONDITION	PART	SYMBOL	MIN	TYP.	MAX	UNIT
Luminous intensity ²⁾	$I_F = 10\text{ mA}$	TLHR5200	I_V	10	20		mcd
		TLHR5201	I_V	16	30		mcd
		TLHR5205	I_V	25	40		mcd
Dominant wavelength	$I_F = 10\text{ mA}$		λ_d	612		625	nm
Peak wavelength	$I_F = 10\text{ mA}$		λ_p		635		nm
Angle of half intensity	$I_F = 10\text{ mA}$		ϕ		± 14		deg
Forward voltage	$I_F = 20\text{ mA}$		V_F		2	3	V
Reverse voltage	$I_R = 10\text{ }\mu\text{A}$		V_R	6	15		V
Junction capacitance	$V_R = 0, f = 1\text{ MHz}$		C_j		50		pF

Note:

¹⁾ $T_{amb} = 25\text{ }^\circ\text{C}$, unless otherwise specified

²⁾ In one packing unit $I_{Vmin}/I_{Vmax} \leq 0.5$

OPTICAL AND ELECTRICAL CHARACTERISTICS¹⁾ TLHY52..., YELLOW							
PARAMETER	TEST CONDITION	PART	SYMBOL	MIN	TYP.	MAX	UNIT
Luminous intensity ²⁾	$I_F = 10\text{ mA}$	TLHY5200	I_V	10	30		mcd
		TLHY5201	I_V	16	40		mcd
		TLHY5205	I_V	25	50		mcd
Dominant wavelength	$I_F = 10\text{ mA}$		λ_d	581		594	nm
Peak wavelength	$I_F = 10\text{ mA}$		λ_p		585		nm
Angle of half intensity	$I_F = 10\text{ mA}$		ϕ		± 14		deg
Forward voltage	$I_F = 20\text{ mA}$		V_F		2.4	3	V
Reverse voltage	$I_R = 10\text{ }\mu\text{A}$		V_R	6	15		V
Junction capacitance	$V_R = 0, f = 1\text{ MHz}$		C_j		50		pF

Note:

¹⁾ $T_{amb} = 25\text{ }^\circ\text{C}$, unless otherwise specified

²⁾ In one packing unit $I_{Vmin}/I_{Vmax} \leq 0.5$

OPTICAL AND ELECTRICAL CHARACTERISTICS ¹⁾ TLHG52., GREEN							
PARAMETER	TEST CONDITION	PART	SYMBOL	MIN	TYP.	MAX	UNIT
Luminous intensity ²⁾	$I_F = 10 \text{ mA}$	TLHG5200	I_V	16	30		mcd
		TLHG5201	I_V	25	40		mcd
		TLHG5205	I_V	40	50		mcd
Dominant wavelength	$I_F = 10 \text{ mA}$		λ_d	562		575	nm
Peak wavelength	$I_F = 10 \text{ mA}$		λ_p		565		nm
Angle of half intensity	$I_F = 10 \text{ mA}$		ϕ		± 14		deg
Forward voltage	$I_F = 20 \text{ mA}$		V_F		2.4	3	V
Reverse voltage	$I_R = 10 \mu\text{A}$		V_R	6	15		V
Junction capacitance	$V_R = 0, f = 1 \text{ MHz}$		C_j		50		pF

Note:

¹⁾ $T_{amb} = 25 \text{ }^\circ\text{C}$, unless otherwise specified

²⁾ In one packing unit $I_{Vmin}/I_{Vmax} \leq 0.5$

TYPICAL CHARACTERISTICS

$T_{amb} = 25 \text{ }^\circ\text{C}$, unless otherwise specified

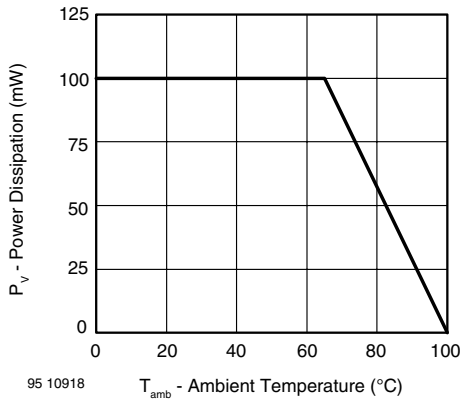

Figure 1. Power Dissipation vs. Ambient Temperature

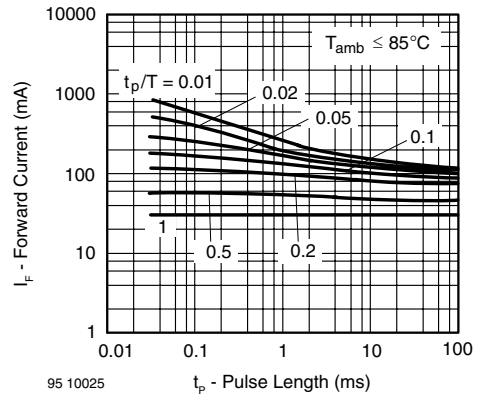

Figure 3. Forward Current vs. Pulse Length

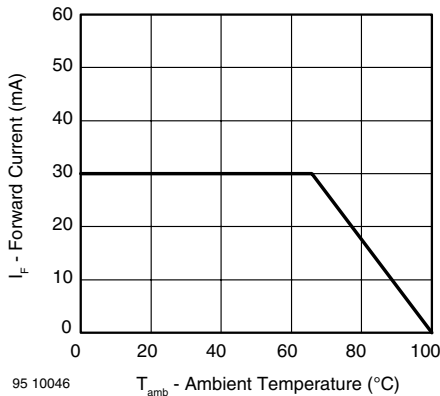

Figure 2. Forward Current vs. Ambient Temperature

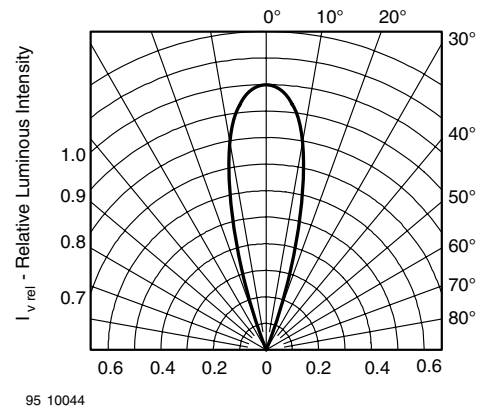

Figure 4. Rel. Luminous Intensity vs. Angular Displacement

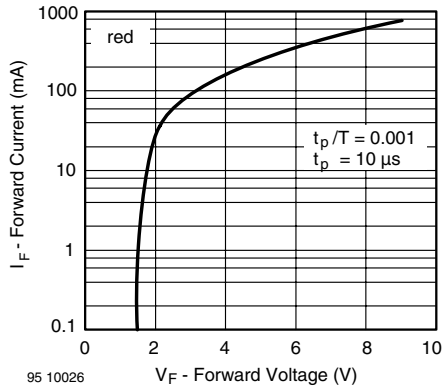

Figure 5. Forward Current vs. Forward Voltage

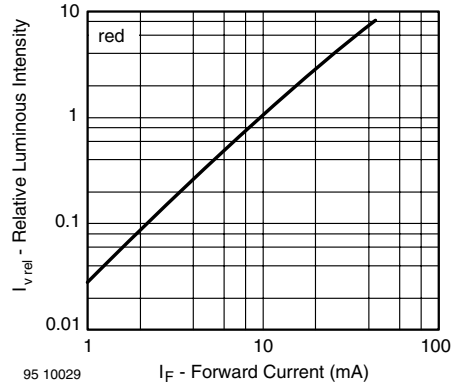

Figure 8. Relative Luminous Intensity vs. Forward Current

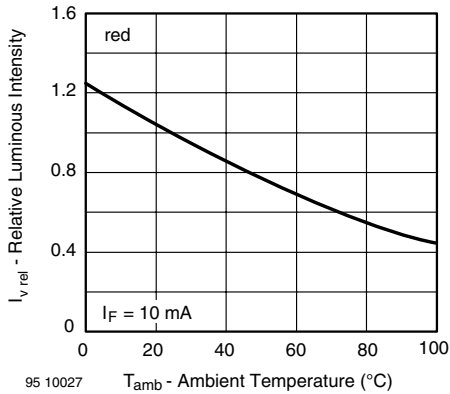

Figure 6. Rel. Luminous Intensity vs. Ambient Temperature

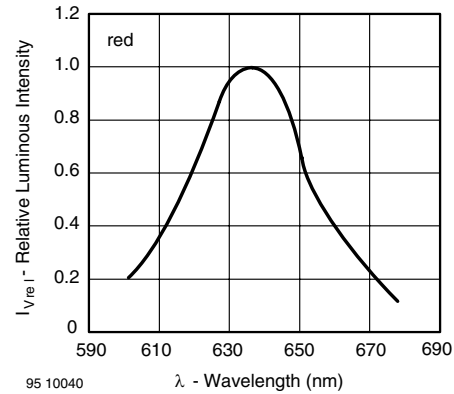

Figure 9. Relative Intensity vs. Wavelength

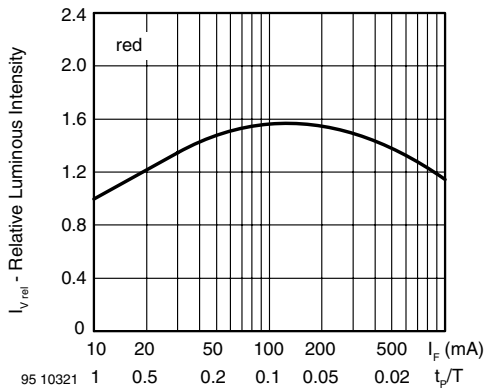

Figure 7. Rel. Lumin. Intensity vs. Forw. Current/Duty Cycle

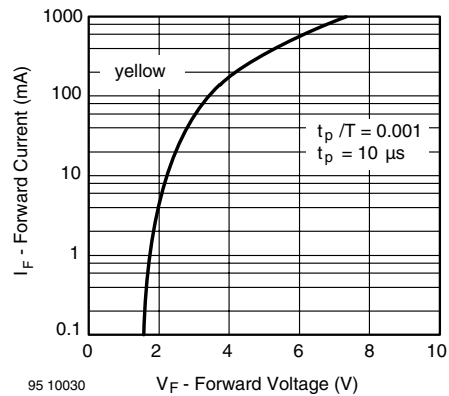

Figure 10. Forward Current vs. Forward Voltage

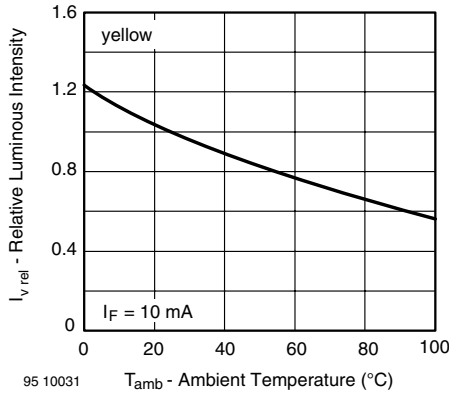

Figure 11. Rel. Luminous Intensity vs. Ambient Temperature

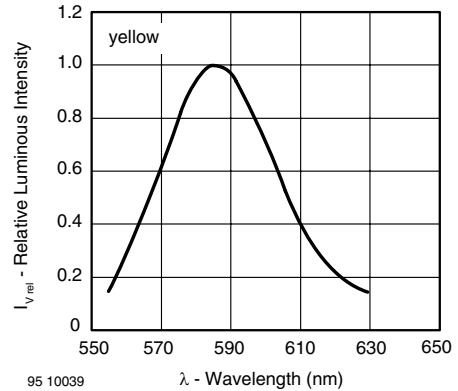

Figure 14. Relative Intensity vs. Wavelength

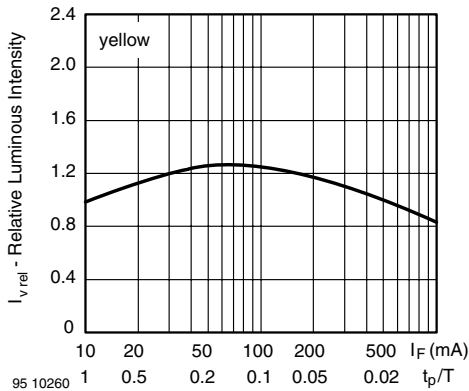

Figure 12. Rel. Lumin. Intensity vs. Forw. Current/Duty Cycle

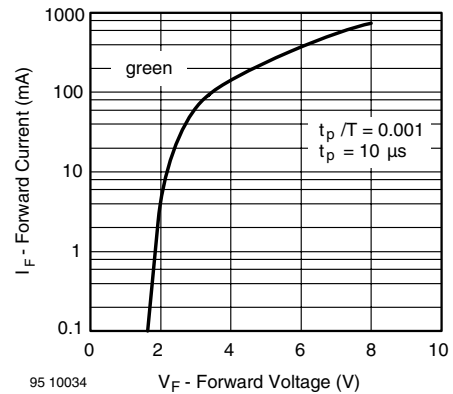

Figure 15. Forward Current vs. Forward Voltage

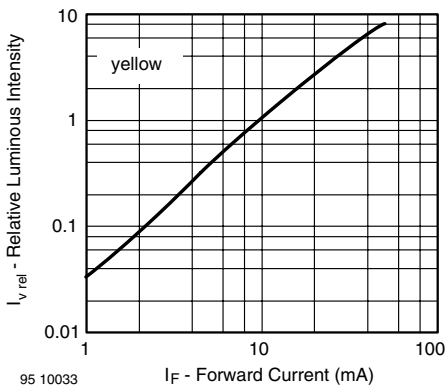

Figure 13. Relative Luminous Intensity vs. Forward Current

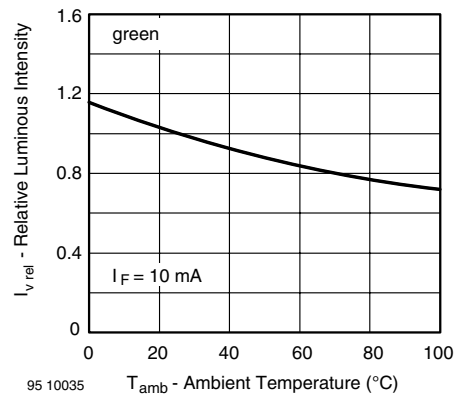

Figure 16. Rel. Luminous Intensity vs. Ambient Temperature

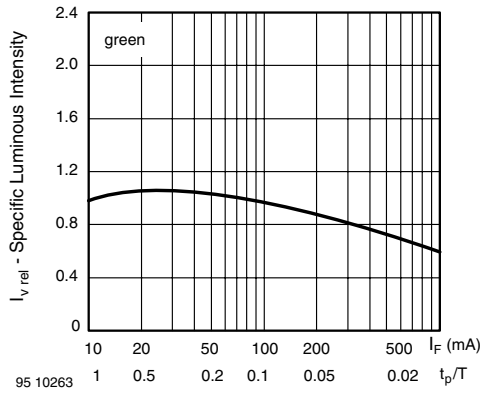

Figure 17. Specific Luminous Intensity vs. Forward Current

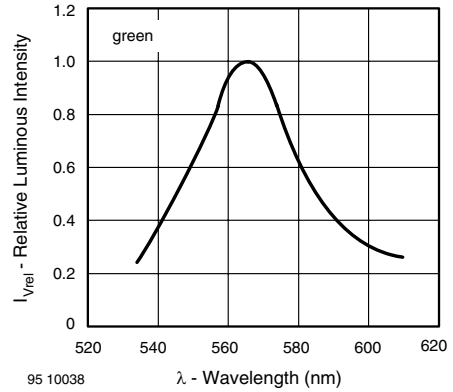

Figure 19. Relative Intensity vs. Wavelength

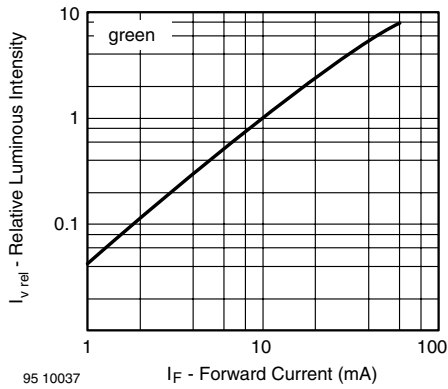
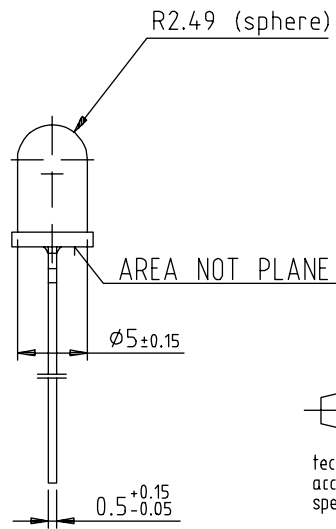
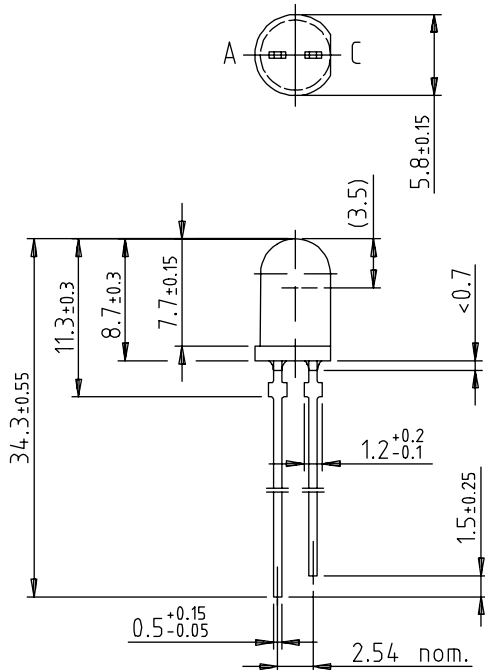

Figure 18. Relative Luminous Intensity vs. Forward Current

PACKAGE DIMENSIONS in millimeters



95 11260

 technical drawings according to DIN specifications



Ozone Depleting Substances Policy Statement

It is the policy of Vishay Semiconductor GmbH to

1. Meet all present and future national and international statutory requirements.
2. Regularly and continuously improve the performance of our products, processes, distribution and operating systems with respect to their impact on the health and safety of our employees and the public, as well as their impact on the environment.

It is particular concern to control or eliminate releases of those substances into the atmosphere which are known as ozone depleting substances (ODSs).

The Montreal Protocol (1987) and its London Amendments (1990) intend to severely restrict the use of ODSs and forbid their use within the next ten years. Various national and international initiatives are pressing for an earlier ban on these substances.

Vishay Semiconductor GmbH has been able to use its policy of continuous improvements to eliminate the use of ODSs listed in the following documents.

1. Annex A, B and list of transitional substances of the Montreal Protocol and the London Amendments respectively
2. Class I and II ozone depleting substances in the Clean Air Act Amendments of 1990 by the Environmental Protection Agency (EPA) in the USA
3. Council Decision 88/540/EEC and 91/690/EEC Annex A, B and C (transitional substances) respectively.

Vishay Semiconductor GmbH can certify that our semiconductors are not manufactured with ozone depleting substances and do not contain such substances.

We reserve the right to make changes to improve technical design
and may do so without further notice.

Parameters can vary in different applications. All operating parameters must be validated for each customer application by the customer. Should the buyer use Vishay Semiconductors products for any unintended or unauthorized application, the buyer shall indemnify Vishay Semiconductors against all claims, costs, damages, and expenses, arising out of, directly or indirectly, any claim of personal damage, injury or death associated with such unintended or unauthorized use.

Vishay Semiconductor GmbH, P.O.B. 3535, D-74025 Heilbronn, Germany



Disclaimer

All product specifications and data are subject to change without notice.

Vishay Intertechnology, Inc., its affiliates, agents, and employees, and all persons acting on its or their behalf (collectively, "Vishay"), disclaim any and all liability for any errors, inaccuracies or incompleteness contained herein or in any other disclosure relating to any product.

Vishay disclaims any and all liability arising out of the use or application of any product described herein or of any information provided herein to the maximum extent permitted by law. The product specifications do not expand or otherwise modify Vishay's terms and conditions of purchase, including but not limited to the warranty expressed therein, which apply to these products.

No license, express or implied, by estoppel or otherwise, to any intellectual property rights is granted by this document or by any conduct of Vishay.

The products shown herein are not designed for use in medical, life-saving, or life-sustaining applications unless otherwise expressly indicated. Customers using or selling Vishay products not expressly indicated for use in such applications do so entirely at their own risk and agree to fully indemnify Vishay for any damages arising or resulting from such use or sale. Please contact authorized Vishay personnel to obtain written terms and conditions regarding products designed for such applications.

Product names and markings noted herein may be trademarks of their respective owners.