

液晶之友 电话: 020-33819057
Http://www.lcdfriends.com

SPECIFICATION FOR LCD MODULE

Model No. TM320240AKGWT

Prepared by:	Date:
Checked by :	Date:
Verified by :	Date:
Approved by:	Date:

TIANMA MICROELECTRONICS CO., LTD

REVISION RECORD

Date	Ver.	Ref. Page	Revision No.	Revision Items
2003.9.12	Ver.1.1	2	1	1.9
2003.9.12	Ver.1.1	6	2	5
2003.9.12	Ver.1.1	7	3	6.1
2003.9.12	Ver.1.1	12	4	7.2.3
2003.9.12	Ver.1.1	13	5	7.3
2003.9.12	Ver.1.1	14	6	8.1
2003.11.24	Ver.1.2	11	7	7.1
2003.11.24	Ver.1.2	12	8	7.2.2
2003.11.24	Ver.1.2	12	9	7.2.3
2003.11.24	Ver.1.2	13	10	7.3

1. General Specifications:

- 1.1 Display type: COLOR STN
- 1.2 Display color*¹:
 - Display color: Decided by the Controller
 - Background*²: Black (Red, Green, Blue dots are off state)
- 1.3 Polarizer mode: Transmissive/Negative
- 1.4 Viewing Angle: 6:00
- 1.5 Driving Method: 1/240 Duty 1/15 Bias
- 1.6 Backlight Type: CCFL
 - Backlight Color: WHITE
 - Backlight Life: 15000 hrs (Min.)
- 1.7 Driver: LH1562F4
- 1.8 Data Transfer: 8 Bit Parallel
- 1.9 Operating Temperature: -25----+55
 - Storage Temperature: -35----+65
- 1.10 Power Supply Voltage: VDD=3.3V
- 1.11 LCD Operating Voltage: VLCD=21.6V
- 1.12 Outline Dimensions: Refer to outline drawing on next page
- 1.13 Dot Matrix: 320 X 3(RGB) X 240 Dots
- 1.14 Dot Size: 0.345(R+G+B) × 0.345(mm²)
- 1.15 Dot Pitch: 0.36 × 0.36 (mm²)
- 1.16 Weight: TBD*³

*¹ Color tone is slightly changed by temperature and driving voltage.

*² Color tone will be changed by backlight.

*³ TBD: To Be Determined.

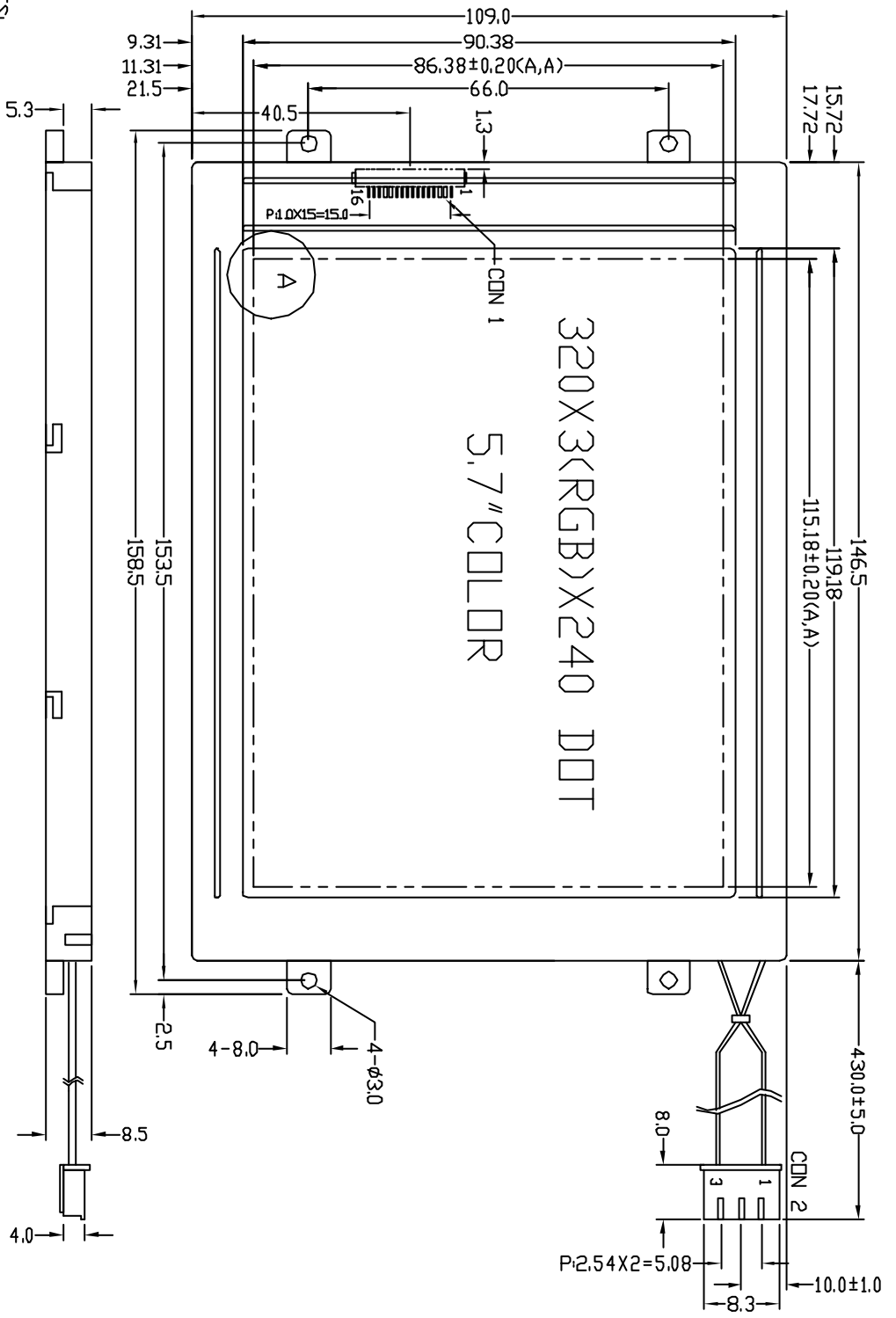

CON 1		CON 2	
PIN	SYMBOL	PIN	SYMBOL
1	N	1	VFL1
2	YD	2	NC
3	LP	3	VFL2
4	XCK		
5	DISPDTF		
6	VDD		
7	VSS		
8	VEE		
9	D7		
10	D6		
11	D5		
12	D4		
13	D3		
14	D2		
15	D1		
16	DD		

DETAIL A:

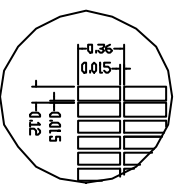

COLOR FILTER

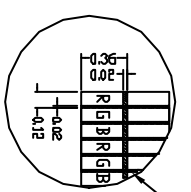

BLACK MASK

- NOTES:
1. DISPLAY TYPE:
 2. VIEWING DIRECTION:
 3. POLARIZER MODE:
 4. DRIVE METHOD:
 5. VEE:
 6. VDD:
 7. OPERATING TEMP:
 8. STORAGE TEMP:
 9. DRIVER:
 10. BACKLIGHT:
 11. BEZEL IS STAINLESS STEEL
 12. ALL UNMARKED TOLERANCES:

COLOR STN
G:00
TRANSMISSIVE/NEGATIVE
1/240 DUTY 1/15 BIAS
21.6V
5.0V
-25°C~+55°C
-35°C~+65°C
LH1562F4
CCFL(A/C)270V WHITE
±0.3mm



TIAN-MA MICROELECTRONICS CO.
22/F., HANGOU Building, Shennan Road, Central, Shenzhen, China

DRAWN BY:	BY:	TITLE: TM20240AKGW/T	SCALE: 1:1
CHECKED BY:	BY:	DWG NO: G-4	UNIT: mm
APPROVED BY:	BY:	DWG NAME: TM20240AKGW/T	SHEET NO: 1 OF 1
CONFIRMED BY:	BY:		

3. LCD Module Part Numbering System

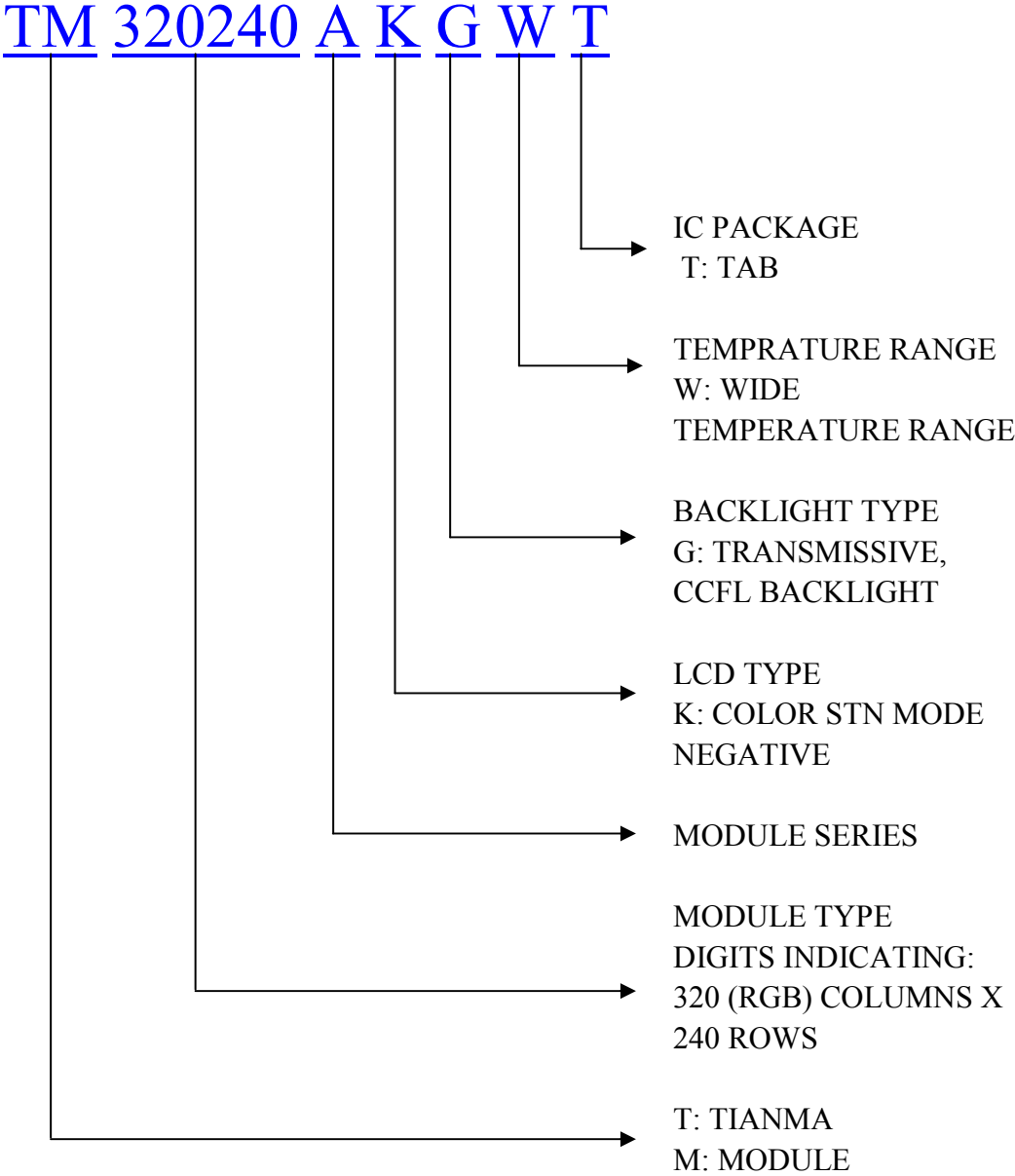

4. Circuit Block Diagram

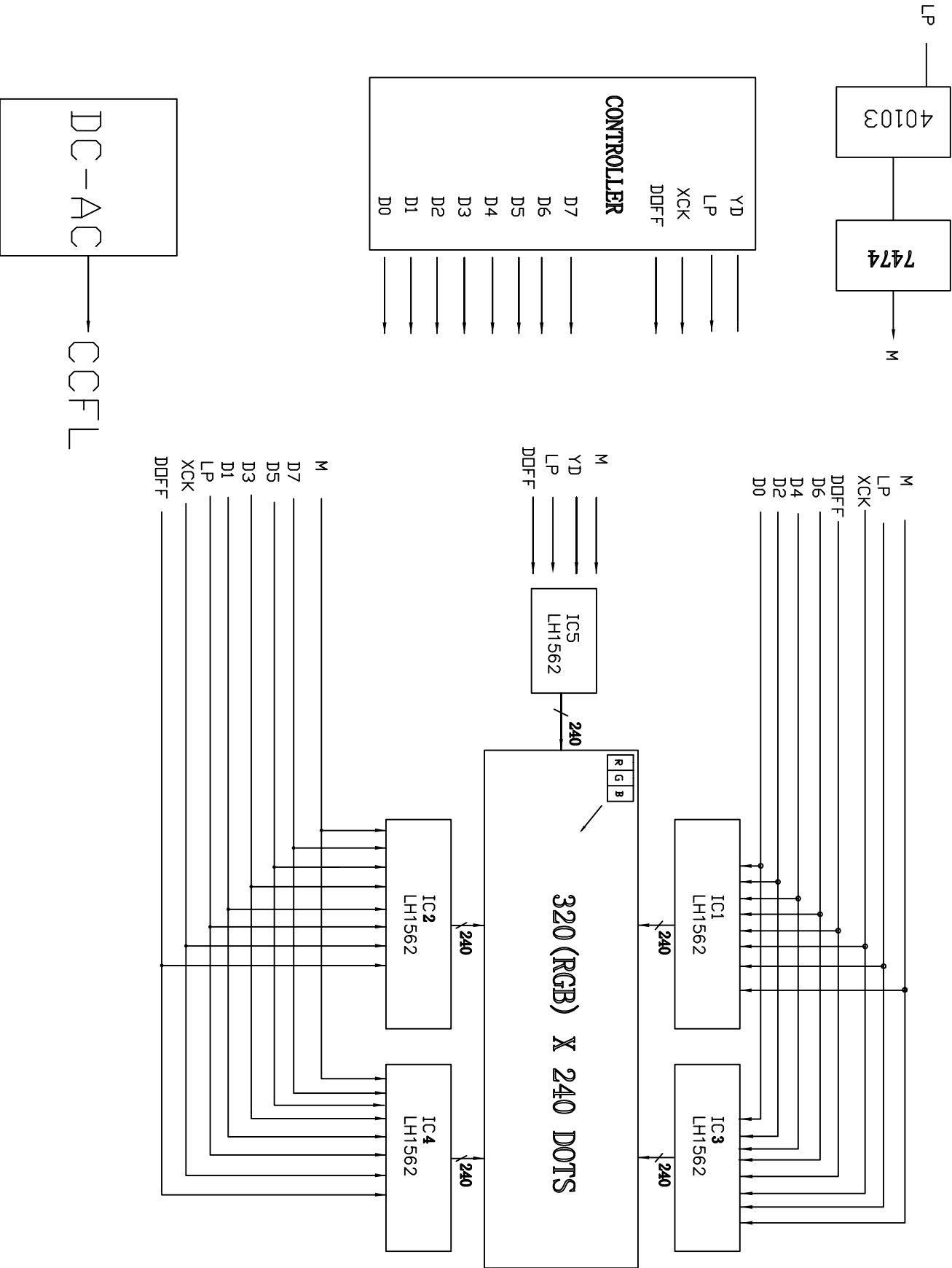

5. Absolute Maximum Ratings

Ta=25

Item	Symbol	Min.	Max.	Unit	Remark
Power Supply Voltage	V _{DD} - V _{SS}	-0.3	+6.0	V	
LCD Driving Voltage	V _{LCD}	-0.3	+40.0		
Operating Temperature Range	T _{OP}	-25	+55		No Condensation
Storage Temperature Range	T _{ST}	-35	+65		

6. Electrical Specifications and Instruction Code

6.1 Electrical characteristics

$V_{SS}=0V$, $T_a=25$

Item	Symbol	Min.	Typ.	Max.	Unit
Supply Voltage (Logic)	$V_{DD}-V_{SS}$	+3.0	+5.0	+5.5	V
Supply Voltage (LCD Drive)	V_{LCD}	-	21.6	-	V
Input Signal Voltage	High V_{IH} ($V_{DD}=3.3$)	$0.8V_{DD}$	-	V_{DD}	V
	Low V_{IL} ($V_{DD}=3.3$)	0	-	$0.2 V_{DD}$	V
Supply current (Logic)	I_{DD} ($V_{DD}-V_{SS}=3.3V$)	-	1.5	-	mA
Supply current (LCD Drive)	I_{EE}	-	4.5	-	mA
Supply Voltage (CCFL Drive)	V_{CL} ($I_{CL}=5.0mA$)	-	270	350	V_{rms}
Supply current (CCFL Drive)	I_{CL}	-	5.0	6.3	mA_{rms}
Frequency (CCFL Drive)	f_{CL}	-	36.6	-	kHz

6.2 Interface Signals

6.2.1 CON1

Pin No.	Symbol	Level	Description
1	M	H/L	Input of signal to AC electrify the liquid crystal drive output
2	YD	H/L	Scan start pulse
3	LP	H/L	Display data latch pulse input
4	XCK	H/L	Display data shift clock input
5	DISPOFF	H/L	H: Display on, L: Display off
6	VDD	+3.3V	Supply voltage for logic
7	VSS	0V	Ground
8	VEE	+23V	LCD voltage input
9	D7	H/L	Data bit 7
10	D6	H/L	Data bit 6
11	D5	H/L	Data bit 5
12	D4	H/L	Data bit 4
13	D3	H/L	Data bit 3
14	D2	H/L	Data bit 2
15	D1	H/L	Data bit 1
16	D0	H/L	Data bit 0

6.2.2 CON2

Pin No.	Symbol	Level	Description
1	VFL1	AC	Supply voltage for CCFL
2	NC	-	No connection
3	VFL2	VSS	Supply voltage for CCFL

6.3 Interface Timing Chart

6.3.1 Segment mode

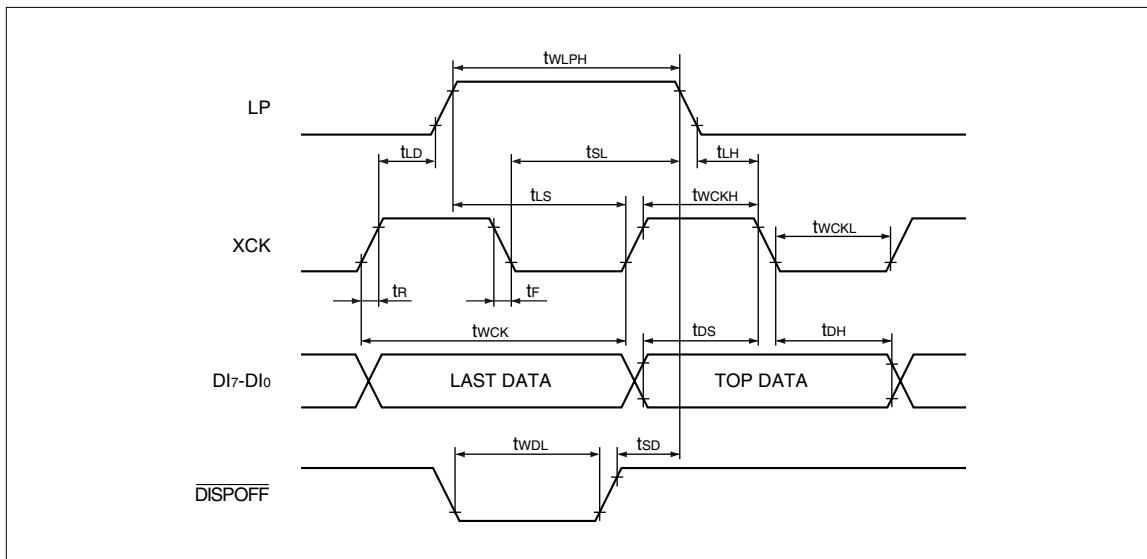

(Segment Mode 2) ($V_{SS} = V_5 = 0\text{ V}$, $V_{DD} = +3.0\text{ to }+4.5\text{ V}$, $V_0 = +15.0\text{ to }+42.0\text{ V}$, $T_{OPR} = -20\text{ to }+85\text{ }^\circ\text{C}$)

PARAMETER	SYMBOL	CONDITIONS	MIN.	TYP.	MAX.	UNIT	NOTE
Shift clock period	tWCK	$t_R, t_F \leq 10\text{ ns}$	66			ns	1
Shift clock "H" pulse width	tWCKH		23			ns	
Shift clock "L" pulse width	tWCKL		23			ns	
Data setup time	tDS		15			ns	
Data hold time	tDH		23			ns	
Latch pulse "H" pulse width	tWLPH		30			ns	
Shift clock rise to latch pulse rise time	tLD		0			ns	
Shift clock fall to latch pulse fall time	tSL		50			ns	
Latch pulse rise to shift clock rise time	tLS		30			ns	
Latch pulse fall to shift clock fall time	tLH		30			ns	
Enable setup time	tS		15			ns	
Input signal rise time	tR				50	ns	2
Input signal fall time	tF				50	ns	2
DISPOFF removal time	tSD		100			ns	
DISPOFF "L" pulse width	tWDL		1.2			μs	
Output delay time (1)	tD	$C_L = 15\text{ pF}$			41	ns	
Output delay time (2)	tPD1, tPD2	$C_L = 15\text{ pF}$			1.2	μs	
Output delay time (3)	tPD3	$C_L = 15\text{ pF}$			1.2	μs	

NOTES :

1. Takes the cascade connection into consideration.
2. $(t_{WCK} - t_{WCKH} - t_{WCKL})/2$ is maximum in the case of high speed operation.

6.3.2 Common Mode

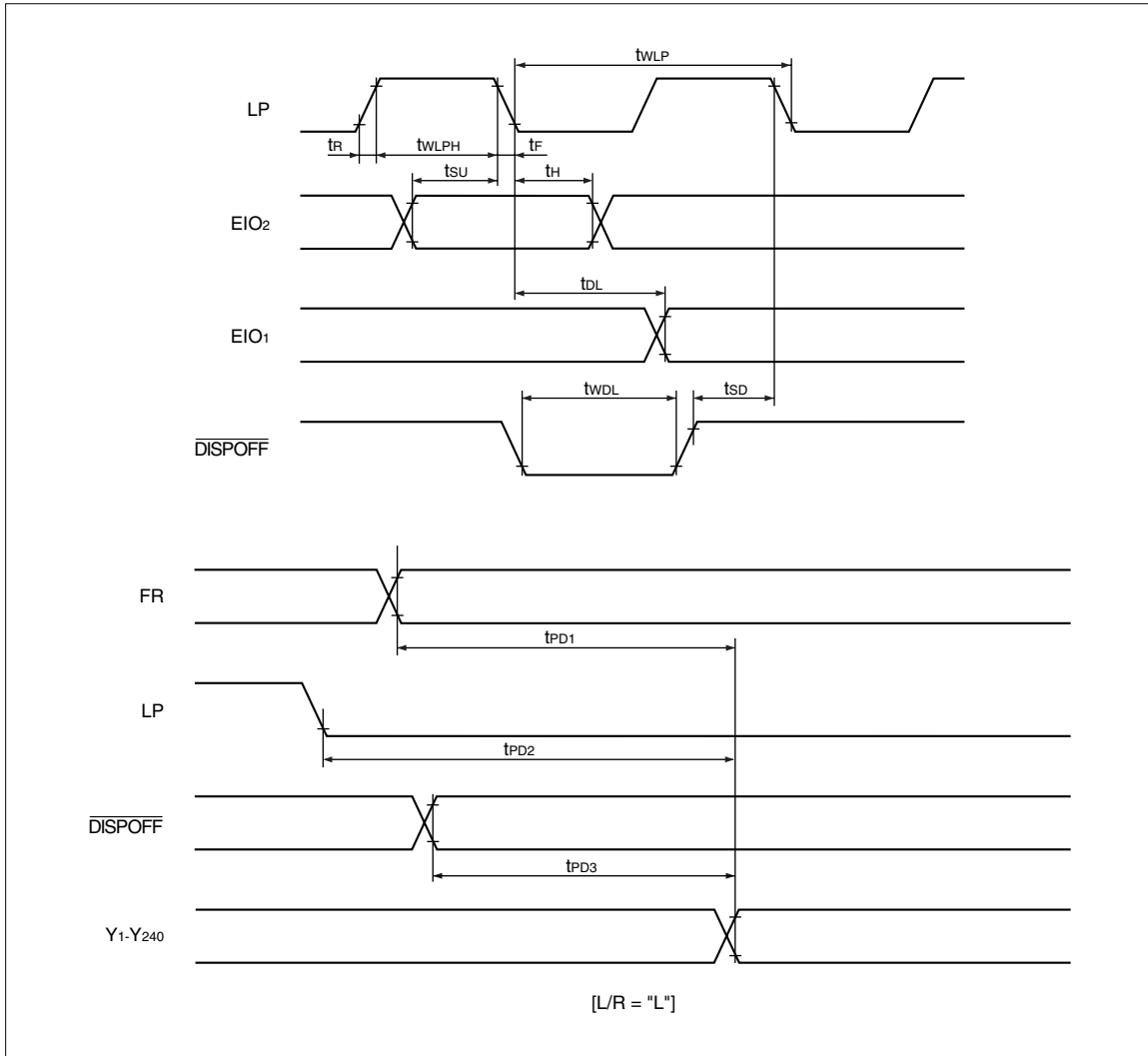

($V_{SS} = V_5 = 0\text{ V}$, $V_{DD} = +2.5\text{ to }+5.5\text{ V}$, $V_0 = +15.0\text{ to }+42.0\text{ V}$, $T_{OPR} = -20\text{ to }+85\text{ }^\circ\text{C}$)

PARAMETER	SYMBOL	CONDITIONS	MIN.	TYP.	MAX.	UNIT
Shift clock period	t_{WLP}	$t_R, t_F \leq 20\text{ ns}$	250			ns
Shift clock "H" pulse width	t_{WLPH}	$V_{DD} = +5.0 \pm 0.5\text{ V}$	15			ns
Data setup time	t_{SU}		30			ns
Data hold time	t_H		50			ns
Input signal rise time	t_R				50	ns
Input signal fall time	t_F				50	ns
DISPOFF removal time	t_{SD}		100			ns
DISPOFF "L" pulse width	t_{WDL}		1.2			μs
Output delay time (1)	t_{DL}	$C_L = 15\text{ pF}$			200	ns
Output delay time (2)	t_{PD1}, t_{PD2}	$C_L = 15\text{ pF}$			1.2	μs
Output delay time (3)	t_{PD3}	$C_L = 15\text{ pF}$			1.2	μs

7. Optical Characteristics

7.1 Optical Characteristics

$V_{LCD}=21.6V$ $T_a=25$

Item	Symbol	Condition	Min.	Typ.	Max.	Unit	
Viewing Angle	x	$C_r \geq 2$	$y=0^\circ$	+30 -- -40			Deg
	y			+30 -- -30			
Contrast Ratio	C_r	$x=0^\circ$ $y=0^\circ$	-	20	-		
Response Time	Turn on	T_{on}	$x=0^\circ$ $y=0^\circ$	-	200	-	ms
	Turn off	T_{off}		-	100	-	
	Red	x	$x=0^\circ$ $y=0^\circ$	-	0.440	-	
		y		-	0.340	-	
	Green	x	$x=0^\circ$ $y=0^\circ$	-	0.300	-	
		y		-	0.434	-	
	Blue	x	$x=0^\circ$ $y=0^\circ$	-	0.215	-	
		y		-	0.300	-	

7.2 Definition of Optical Characteristics

7.2.1 Definition of Viewing Angle

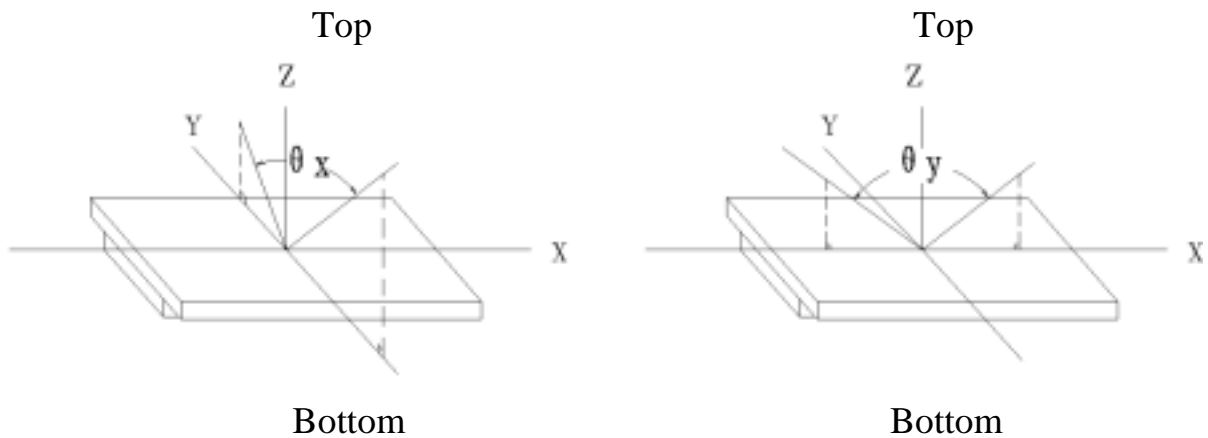

7.2.2 Definition of Contrast Ratio

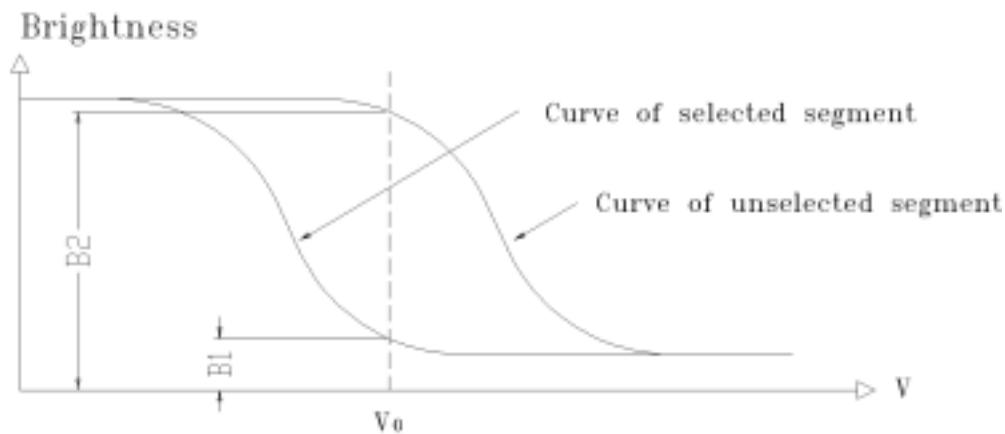

$$\text{Contrast Ratio} = B2/B1 = \frac{\text{unselected state brightness}}{\text{selected state brightness}}$$

Measuring Conditions:

- 1) Ambient Temperature: 25 ;
- 2) Frame frequency: 70Hz

7.2.3 Definition of Response time

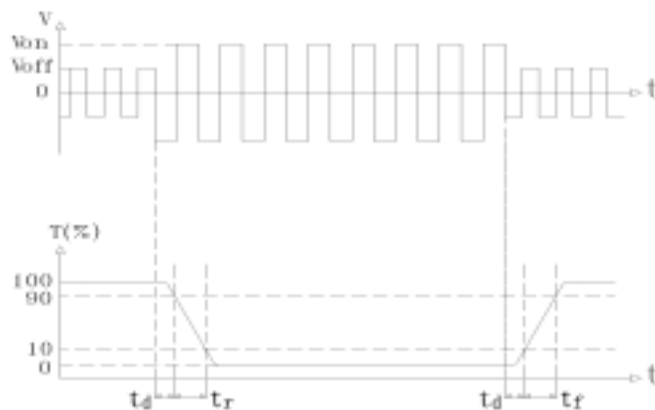

Turn on time: $t_{on} = t_d + t_r$ Turn off time: $t_{off} = t_d + t_r$

Measuring Condition:

- 1) Operating Voltage: 21.6V
- 2) Frame frequency: 70Hz

7.3 Brightness Characteristic

Item	Symbol	Condition	Min.	Typ.	Max.	Unit
Brightness	Bp	Ta=25 ±3	-	120	-	cd/m ²
Uniformity	Bp	30-80%RH	-	80	-	%

Note:

1. The data is measured after CCFLs are turned on for 5 minutes.
2. Testing conditions CCFL: I_{CL} = 5mA (AC)
 LCD: All dots are on (White color)
3. Brightness in the center of the LCD panel.
4. Definition of Uniformity (Bp)
 $Bp = Bp (\text{Min.}) / Bp (\text{Max.}) \times 100 (\%)$
 Bp (Max.) = Maximum brightness in 9 measurement spots
 Bp (Min.) = Minimum brightness in 9 measurement spots

8. Reliability

8.1 Content of Reliability Test

Ta=25

No.	Test Item	Content of Test	Test condition
1	High Temperature Storage	Endurance test applying the high storage temperature for a long time	65 ±2 240H Restore 4H at 25
2	Low Temperature Storage	Endurance test applying the low storage temperature for a long time	-35 ±2 240H Restore 4H at 25
3	High Temperature Operation	Endurance test applying the electric stress (voltage & current) and the thermal stress to the element for a long time	55 ±2 240H Restore 4H at 25
4	Low Temperature Operation	Endurance test applying the electric stress under low temperature for a long time	-25 ±2 240H Restore 4H at 25
5	High Temperature /Humidity Storage	Endurance test applying the high temperature and high humidity storage for a long time	60 ±2 90%RH 240H Restore 4H at 25
6	Temperature Cycle	Endurance test applying the low and high temperature cycle -35 25 65 25 30min 5min 30min 5min 1 cycle	-35 /65 10 cycles Restore 4H at 25
7	Vibration Test (package state)	Endurance test applying the vibration during transportation	10Hz~150Hz, 100m/s ² , 120min
8	Shock Test (package state)	Endurance test applying the shock during transportation	Half- sine wave, 300m/s ² , 18ms
9	Atmospheric Pressure Test	Endurance test applying the atmospheric pressure during transportation by air	25kPa 16H Restore 2H

8.2 Failure Judgment Criterion

Criterion Item	Test Item No.									Failure Judgement Criterion
	1	2	3	4	5	6	7	8	9	
Basic Specification	√	√	√	√	√	√	√	√	√	Out of the basic Specification
Electrical specification	√	√	√	√	√					Out of the electrical specification
Mechanical Specification							√	√		Out of the mechanical specification
Optical Characteristic	√	√	√	√	√	√			√	Out of the optical specification
Note	For test item refer to 8.1									
Remark	Basic specification = Optical specification + Mechanical specification									

9. Quality Level

Examination or Test	At $T_a=25$ (unless otherwise stated)	Inspection				
		Min.	Max.	Unit	IL	AQL
External Visual Inspection	Under normal illumination and eyesight condition, the distance between eyes and LCD is 25cm.	See Appendix A			II	Major 1.0 Minor 2.5
Display Defects	Under normal illumination and eyesight condition, display on inspection.	See Appendix B			II	Major 1.0 Minor 2.5
<p>Note: Major defects: Open segment or common, Short, Serious damages, Leakage Miner defects: Others Sampling standard conforms to GB2828</p>						

10. Precautions for Use of LCD Modules

10.1 Handling Precautions

10.1.1 The display panel is made of glass. Do not subject it to a mechanical shock by dropping it from a high place, etc.

10.1.2 If the display panel is damaged and the liquid crystal substance inside it leaks out, be sure not to get any in your mouth, if the substance comes into contact with your skin or clothes, promptly wash it off using soap and water.

10.1.3 Do not apply excessive force to the display surface or the adjoining areas since this may cause the color tone to vary.

10.1.4 The polarizer covering the display surface of the LCD module is soft and easily scratched. Handle this polarizer carefully.

10.1.5 If the display surface is contaminated, breathe on the surface and gently wipe it with a soft dry cloth. If still not completely clear, moisten cloth with one of the following solvents:

- Isopropyl alcohol
- Ethyl alcohol

Solvents other than those mentioned above may damage the polarizer. Especially, do not use the following:

- Water
- Ketone
- Aromatic solvents

10.1.6 Do not attempt to disassemble the LCD Module.

10.1.7 If the logic circuit power is off, do not apply the input signals.

10.1.8 To prevent destruction of the elements by static electricity, be careful to maintain an optimum work environment.

- a. Be sure to ground the body when handling the LCD Modules.
- b. Tools required for assembly, such as soldering irons, must be properly ground.
- c. To reduce the amount of static electricity generated, do not conduct assembly and other work under dry conditions.
- d. The LCD Module is coated with a film to protect the display surface. Be care when peeling off this protective film since static electricity may be generated.

10.2 Storage precautions

10.2.1 When storing the LCD modules, avoid exposure to direct sunlight or to the light of fluorescent lamps.

10.2.2 The LCD modules should be stored under the storage temperature range. If the LCD modules will be stored for a long time, the recommend condition is:

Temperature : 0 ~ 40

Relatively humidity: 80%

10.2.3 The LCD modules should be stored in the room without acid, alkali and harmful gas.

10.3 The LCD modules should be no falling and violent shocking during transportation, and also should avoid excessive press, water, damp and sunshine.

Appendix A

Inspection items and criteria for appearance defects

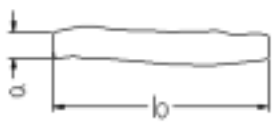
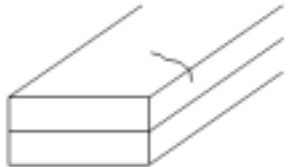
Items	Contents	Criteria		
Leakage		Not permitted		
Rainbow		According to the limit specimen		
Polarizer	Wrong polarizer attachment	Not permitted		
	Bubble between polarizer and glass	Not counted	Max. 3 defects allowed	
		$\phi < 0.3\text{mm}$	0.3mm ϕ 0.5mm	
	Scratches of polarizer	According to the limit specimen		
Black spot (in viewing area)		Not counted	Max. 3 spots allowed	Max. 3 spots (lines) allowed
		$X < 0.2\text{mm}$	0.2mm X 0.5mm	
		$X = (a+b)/2$		
Black line (in viewing area)		Not counted	Max. 3 lines allowed	
		$a < 0.02\text{mm}$	0.02mm a 0.05mm b 2.0mm	
Progressive cracks		Not permitted		

Appendix A

Inspection item and criteria for appearance defects (continued)

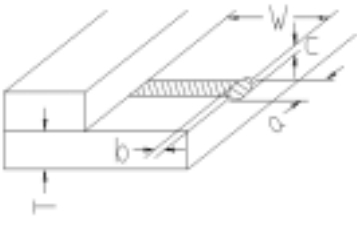
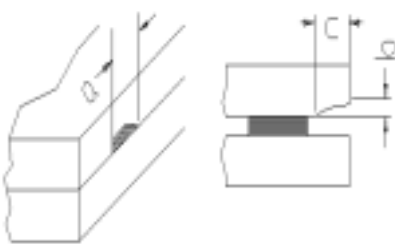
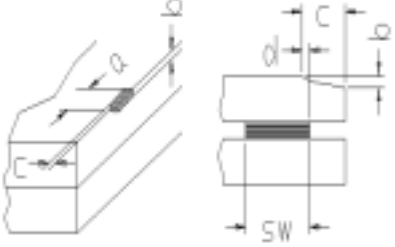
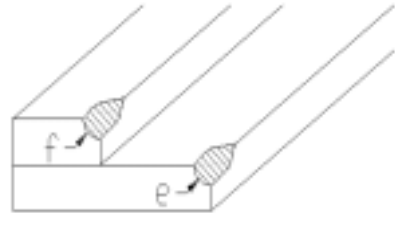
Items	Contents	Criteria							
Glass Cracks	Cracks on pads 	a	b	c	Max. 2 cracks allowed	Max. 5 cracks allowed			
		3mm	W/5	T/2					
		2mm	W/5	$T/2 < C < T$					
	Cracks on contact side 	a	b		Max. 2 cracks allowed				
		3mm	T/2						
		2mm	$T/2 < b < T$						
		C shall be not reach the seal area							
	Cracks on non-contact side 	a	b		Max. 2 cracks allowed				
		3mm	T/2						
		2mm	$T/2 < b < T$						
	C 0.5mm								
	d SW/3								
Corner cracks 	$e < 2.0\text{mm}^2$ $f < 2.0\text{mm}^2$			Max. 3 cracks allowed					

Appendix B

Inspection items and criteria for display defects

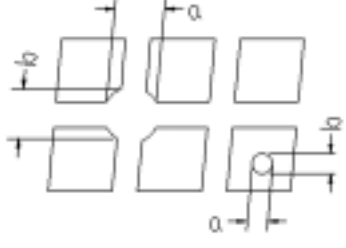
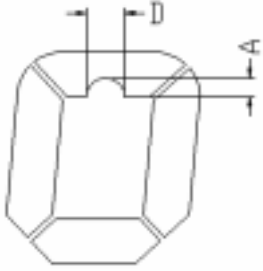
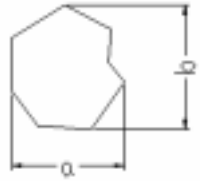
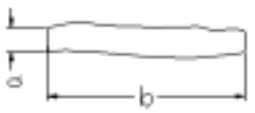
Items	Contents	Criteria			
Open segment or open common		Not permitted			
Short		Not permitted			
Wrong viewing angle		Not permitted			
Contrast ratio uneven		According to the limit specimen			
Crosstalk		According to the limit specimen			
Pin holes and cracks in segment (DOT)		Not counted	Max.3 dots allowed		Max.3 dots allowed
		$X < 0.1\text{mm}$	0.1mm X 0.2mm		
		$X = (a+b)/2$			
		Not counted	Max.2 dots allowed		
		$A < 0.1\text{mm}$	0.1mm A 0.2mm $D < 0.25\text{mm}$		
Black spot (in viewing area)		Not counted	Max.3 spots allowed		Max.3 spots (lines) allowed
		$X < 0.1\text{mm}$	0.1mm X 0.2mm		
		$X = (a+b)/2$			
Black line (in viewing area)		Not counted	Max.3 lines allowed		
		$a < 0.02\text{mm}$	0.02mm a 0.05mm b 0.5mm		

Appendix B

Inspection items and criteria for display defects (continued)

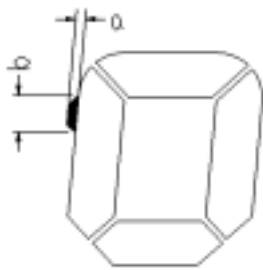
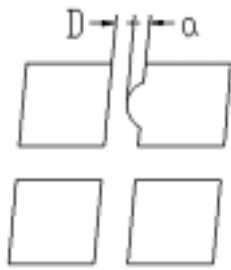
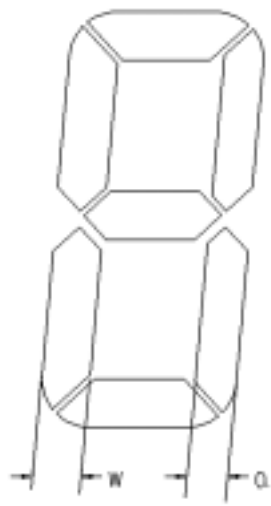
Items	Content	Criteria			
Transformation of segment		Not counted	Max. 2 defects allowed	Max.3 defects allowed	
		$x < 0.1\text{mm}$	0.1mm x 0.2mm		
		$x = (a+b)/2$			
		Not counted	Max. 1 defects allowed		
		$a < 0.1\text{mm}$	0.1mm a 0.2mm $D > 0$		
		Max.2 defects allowed $0.8W \leq a \leq 1.2W$ a=measured value of width W=nominal value of width			