



LR18120

CMOS IC

2A LOW DROPOUT REGULATOR WITH ENABLE

DESCRIPTION

The UTC **LR18120** is a positive voltage regulator with high performance. It has low dropout voltage and low input voltage, besides its output voltage can be fixed at 1.2V, 1.5V, 1.8V, or 2.5V depending on internal feedback resistors or ADJ (not connected to the ground) with external feedback resistors. The input voltage of UTC **LR18120** can be low to 1.4V. There are two additional pin in the LR18120. One is EN pin and the other is POK pin.

The UTC **LR18120** is specially made for applications with low input voltage, low dropout voltage, and low output voltage which is almost the same as the input voltage. Typical applications include motherboards, notebooks, set top boxes, network cards and peripheral cards.

FEATURES

- * V_{IN} as Low as 1.4V and V_{PP} Voltage 5V
- * $V_D=320mV$ @ $I_{OUT}=2A$, $V_{OUT}=1.2V$
- * Internal Over Current and Over Temperature Protection
- * With Enable Pin
- * Output Voltage: $\pm 2\%$
- * 1.2V, 1.5V, 1.8V and 2.5V Output Voltage Adjustable Externally Using Resistors
- * When Disable V_{OUT} Pull Low Resistance

ORDERING INFORMATION

Ordering Number	Package	Packing
LR18120G-xx-S08-R	SOP-8	Tape Reel
LR18120G-xx-SH2-R	HSOP-8	Tape Reel

<p>LR18120G-xx-S08-R</p>	<p>(1) R: Tape Reel</p> <p>(2) S08: SOP-8, HSOP-8: SH2</p> <p>(3) xx: Refer to Marking Information</p> <p>(4) G: Halogen Free</p>
--------------------------	---

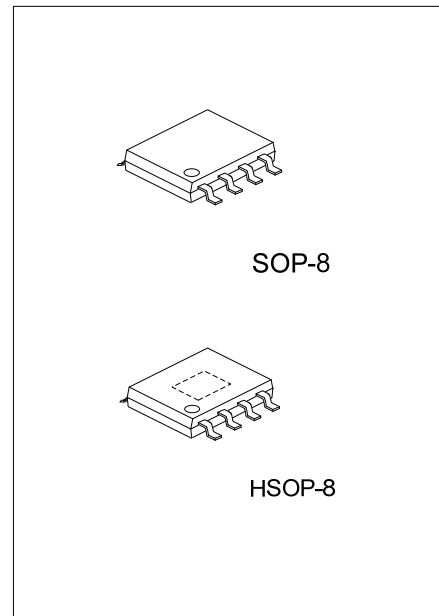

MARKING INFORMATION

PACKAGE	VOLTAGE CODE	MARKING
SOP-8 HSOP-8	12:1.2V 15:1.5V 18:1.8V 25:2.5V	<p>The marking diagram shows an 8-pin package with pins numbered 1 to 8. The marking includes 'UTC' and 'LR18120G'. A 'Voltage Code' is indicated on the left side, and 'Data Code' and 'Lot Code' are indicated on the right side.</p>

PIN CONFIGURATION

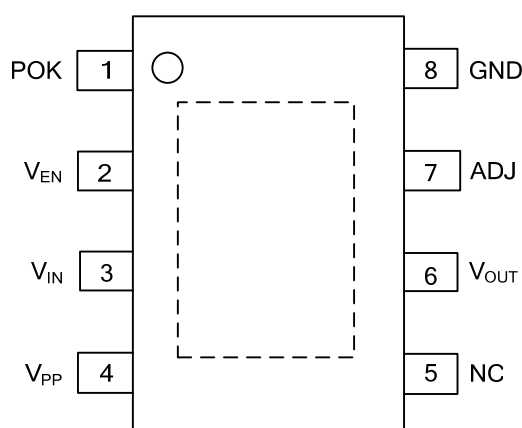

PIN DESCRIPTION

PIN NO.	PIN NAME	DESCRIPTION
1	POK	This pin will Indicate high under this situation: V_O reaches 92% of its rating voltage. Open-drain output.
2	V_{EN}	The enable control Input pin. As while as this pin's voltage falls below 0.4V ,the LR18120 will stop working. When there's nothing connected with this pin,the device will be enabled.
3	V_{IN}	The pin of input voltage. Placing large capacitance closely to this pin is necessary. There should be connected a 10 μ F ceramic capacitor.
4	V_{PP}	This pin is for input voltage to control circuit.
5	NC	Connected nothing.
6	V_{OUT}	The voltage output pin.
7	ADJ	When this pin connected to the ground, V_{OUT} will be set by the internal feedback resistors. Otherwise, if using external feedback resistors to decide the V_{OUT} , $V_{OUT} = 0.8(R1+R2)/R2$ Volts.
8	GND	Ground.

■ BLOCK DIAGRAM

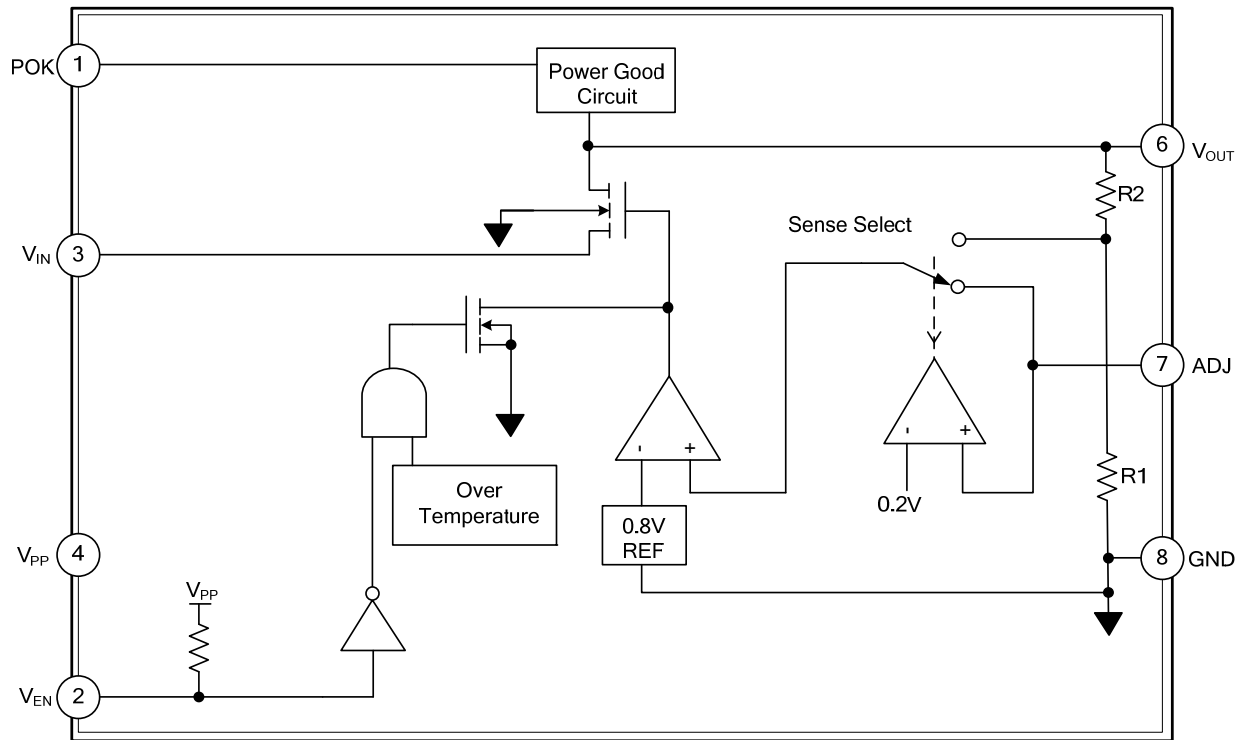

■ ABSOLUTE MAXIMUM RATING

PARAMETER	SYMBOL	RATINGS	UNIT
Input Voltage	V_{PP}, V_{IN}	7	V
Power Dissipation	P_D	Internally limited	
Junction Temperature	T_J	150	°C
Ambient Operation Temperature	T_{OPR}	-40~ +85	°C
Storage Temperature	T_{STG}	-65~ +150	°C

Note: Absolute maximum ratings are those values beyond which the device could be permanently damaged.

Absolute maximum ratings are stress ratings only and functional device operation is not implied.

■ RECOMMENDED OPERATING CONDITIONS

PARAMETER	SYMBOL	RATINGS	UNIT
V_{IN} Voltage	V_{IN}	1.4 ~5.5	V
V_{PP} Voltage	V_{PP}	4.5~5.5	V
Ambient Operation Temperature	T_{OPR}	-40°C ≤ T_{OPR} ≤ +85°C	°C

■ THERMAL DATA

PARAMETER	SYMBOL	RATINGS	UNIT
Junction to Ambient	SOP-8	150	°C/W
	HSOP-8	143	°C/W
Junction to Case	SOP-8	20	°C/W
	HSOP-8	14	°C/W

■ ELECTRICAL CHARACTERISTICS

$V_{PP}=5V$, $V_{IN}=3.3V$, $V_{EN}=V_{PP}$, $I_{OUT}=10mA$, $C_{IN}=10\mu F$, $C_{OUT}=10\mu F$, $T_A=T_J=25^\circ C$ unless otherwise specified.

PARAMETER	SYMBOL	TEST CONDITIONS	MIN	TYP	MAX	UNIT
V_{IN}						
Input Voltage Range	V_{IN}		1.4		5.5	V
Quiescent Current (Ground Current)	I_Q	$V_{OUT}=2.5V$		1	2	mA
V_{PP}						
V_{PP} Voltage Range	V_{PP}		4.5		5.5	V
V_{PP} Current	I_{PPH}	$V_{OUT}=2.5V$		0.23	0.5	mA
	I_{PPL}	$V_{EN}=0V$		36	60	μA
V_{OUT}						
Output Voltage (Internal Fixed Voltage)	V_{OUT}	$V_{IN}=V_{OUT}+0.5V$, $V_{OUT}=2.5V$	2.45	2.5	2.55	V
Line Regulation	$\frac{\Delta V_{OUT}}{\Delta V_{IN} \times V_{OUT}}$	$V_{IN}=(V_{OUT}+0.5V) \sim 5V$		0.2	1	%
Load Regulation	ΔV_{OUT}	$10mA \leq I_{OUT} \leq 2A$		0.2	1	%
Dropout Voltage	V_D	$I_{OUT}=2A$		250	320	mV
Short Circuit Current				1.4		A
V_{OUT} Pull Low Resistance		$V_{EN}=0V$		90		Ω
ADJ						
Reference Voltage	V_{REF}	$V_{ADJ}=V_{OUT}$	0.788	0.8	0.812	V
Adjust Pin Current	I_{ADJ}			20	100	nA
Adjust Pin Threshold			0.15	0.2	0.25	V
VEN						
V_{EN} Pin Voltage High	$V_{H(EN)}$		1.6			V
V_{EN} Pin Voltage Low	$V_{L(EN)}$				0.4	V
V_{EN} Pin Bias Current	$I_{BIAS(EN)}$	$V_{EN}=0V$		12	40	μA
POK						
V_{OUT} Power OK Voltage	V_{THPOK}			92		%
Hysteresis	V_{HYPOK}			7		%
Over Temperature Protection						
Over Temperature	T_{OT}			150		°C
Over Temperature Hysteresis	T_{OTHY}			30		°C

Note: Low duty pulse techniques are used during test to maintain junction temperature as close to ambient as possible.

■ TYPICAL APPLICATION CIRCUIT

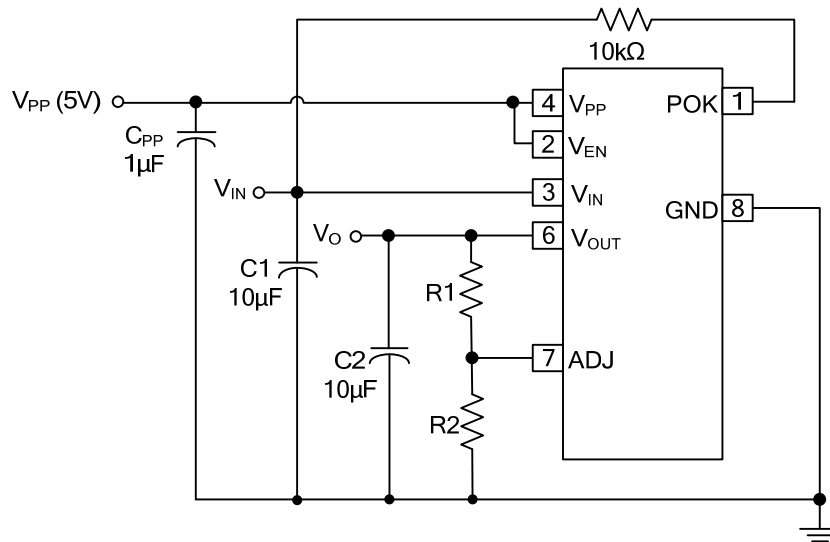

$$V_{OUT} = \frac{0.8(R1 + R2)}{R2} \text{ Volts}$$

R2 < 120kΩ is recommended

■ TYPICAL CHARACTERISTICS ($V_{CC}=3.3V$, $T_A=25^\circ C$, unless otherwise noted.)

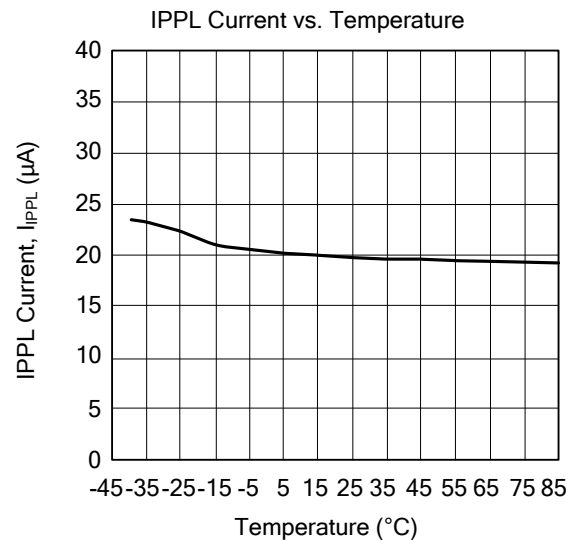
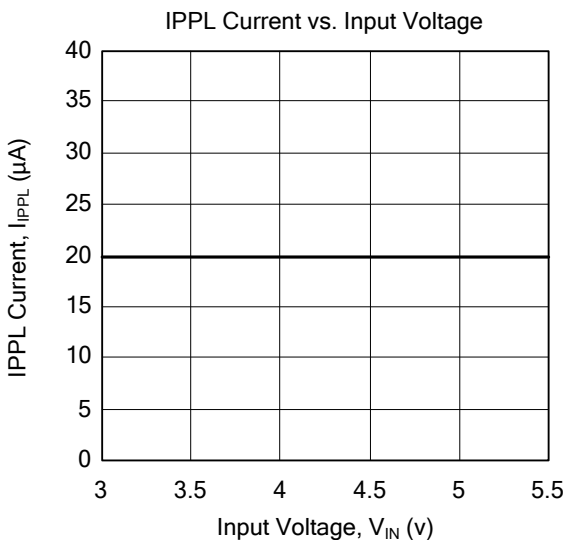
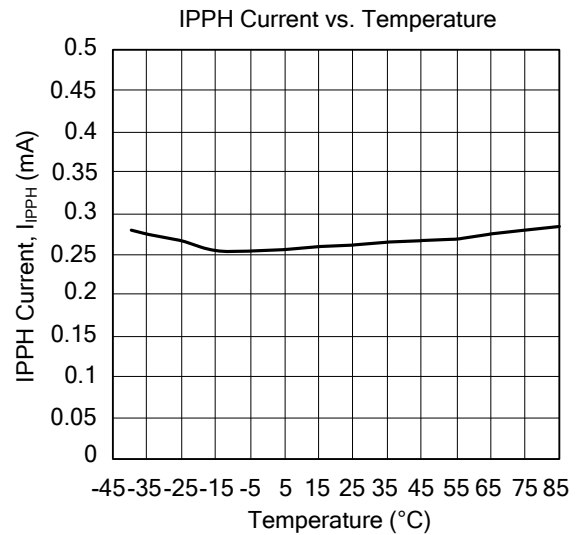
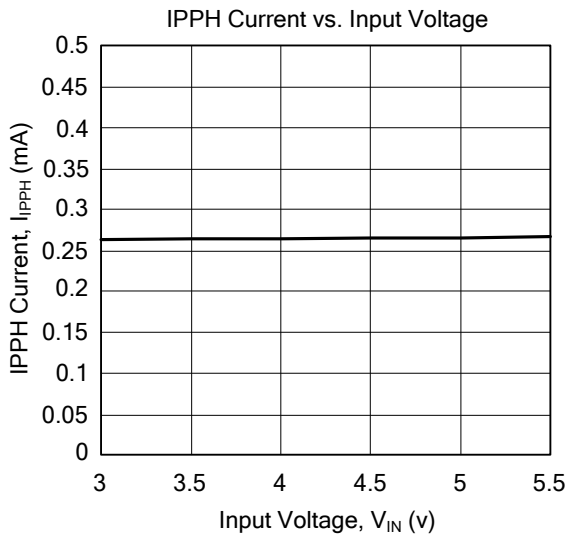
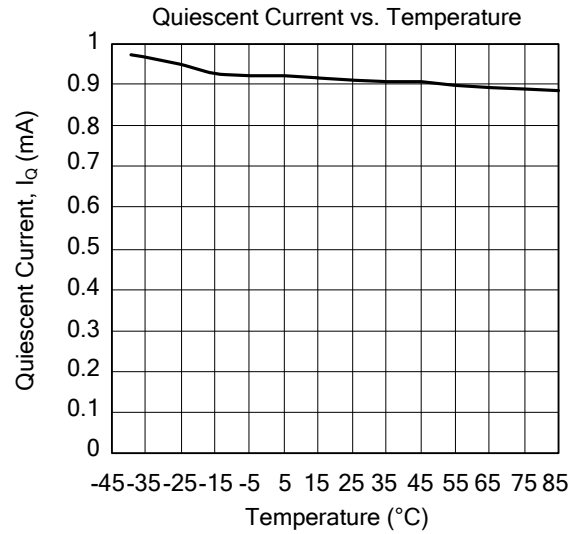
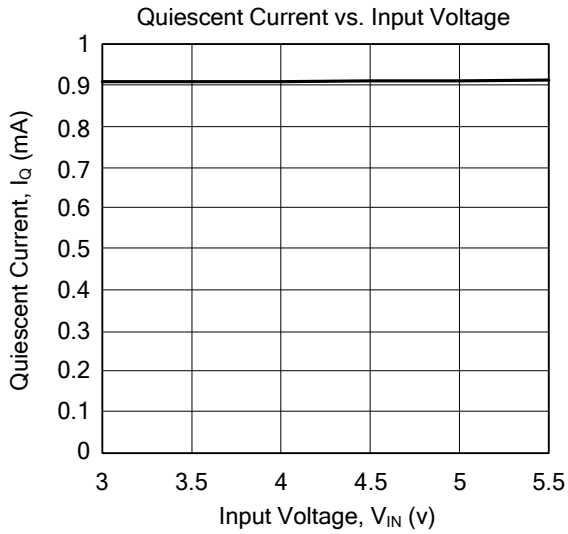

TYPICAL CHARACTERISTICS(Cont.)

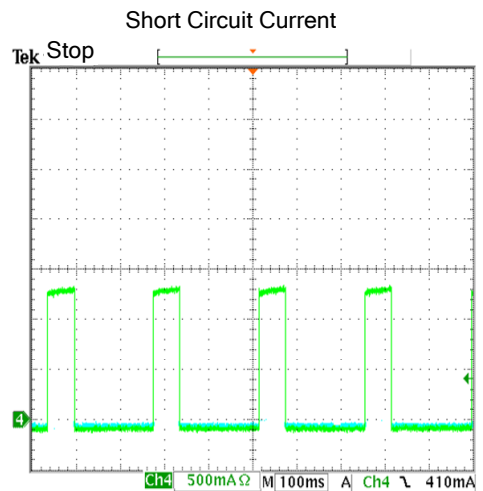
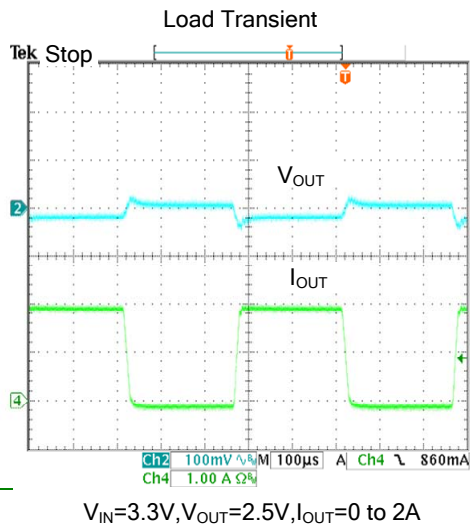
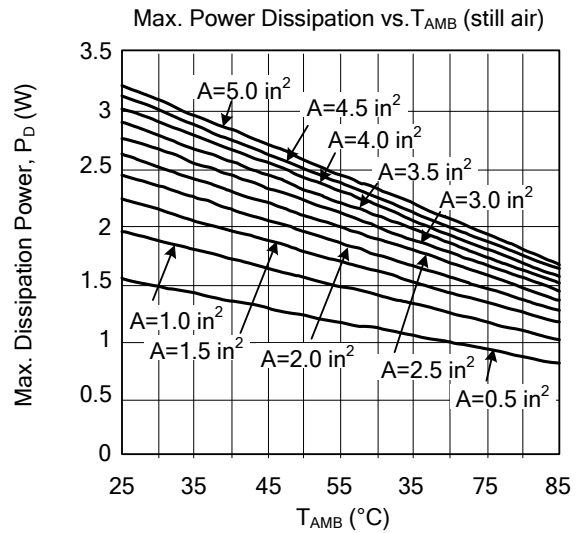
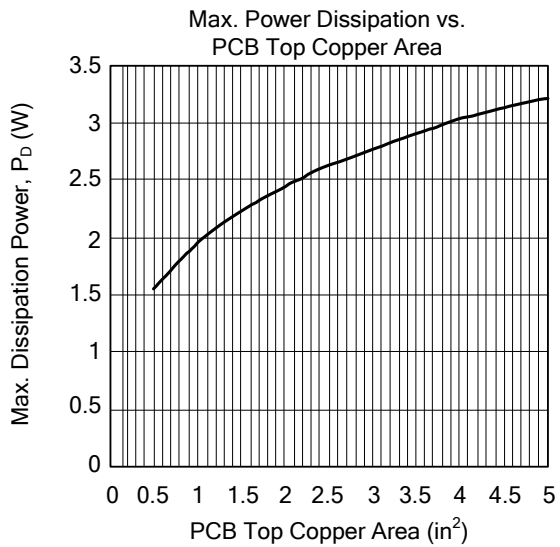
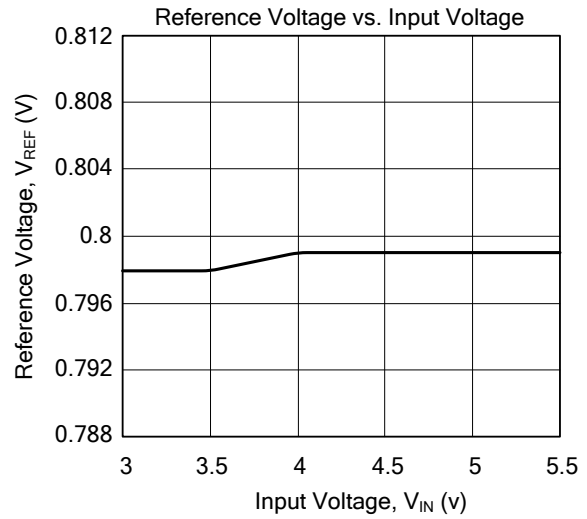
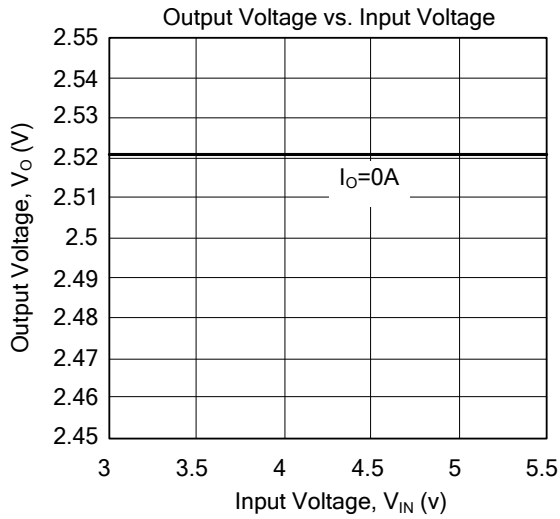

TYPICAL CHARACTERISTICS(Cont.)

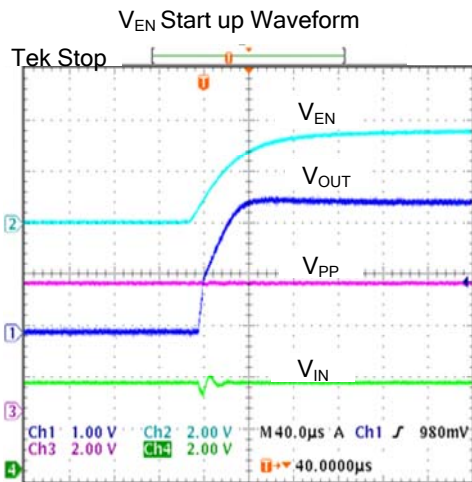
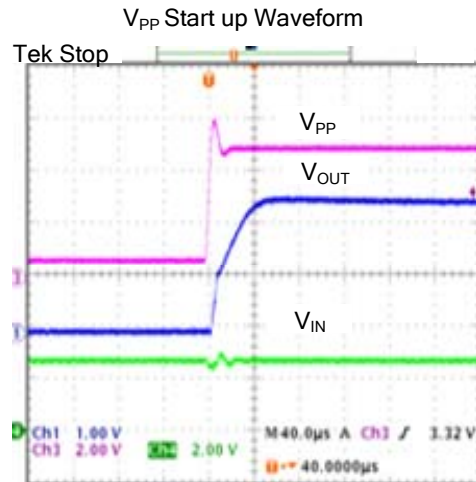
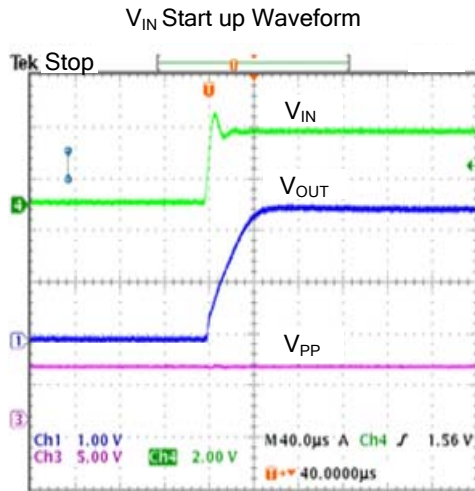

UTC assumes no responsibility for equipment failures that result from using products at values that exceed, even momentarily, rated values (such as maximum ratings, operating condition ranges, or other parameters) listed in products specifications of any and all UTC products described or contained herein. UTC products are not designed for use in life support appliances, devices or systems where malfunction of these products can be reasonably expected to result in personal injury. Reproduction in whole or in part is prohibited without the prior written consent of the copyright owner. The information presented in this document does not form part of any quotation or contract, is believed to be accurate and reliable and may be changed without notice.