

NTMD6N02R2

Power MOSFET 6.0 Amps, 20 Volts

N-Channel Enhancement Mode Dual SO-8 Package

Features

- Ultra Low $R_{DS(on)}$
- Higher Efficiency Extending Battery Life
- Logic Level Gate Drive
- Miniature Dual SOIC-8 Surface Mount Package
- Diode Exhibits High Speed, Soft Recovery
- Avalanche Energy Specified
- SOIC-8 Mounting Information Provided
- Pb-Free Package is Available

Applications

- DC-DC Converters
- Low Voltage Motor Control
- Power Management in Portable and Battery-Powered Products, for example, Computers, Printers, Cellular and Cordless Telephones and PCMCIA Cards

MAXIMUM RATINGS ($T_J = 25^\circ\text{C}$ unless otherwise noted)

Rating	Symbol	Value	Unit
Drain-to-Source Voltage	V_{DSS}	20	V
Drain-to-Gate Voltage ($R_{GS} = 1.0\ \text{M}\Omega$)	V_{DGR}	20	V
Gate-to-Source Voltage - Continuous	V_{GS}	± 12	V
Thermal Resistance, Junction-to-Ambient (Note 1)	$R_{\theta JA}$	62.5	$^\circ\text{C}/\text{W}$
Total Power Dissipation @ $T_A = 25^\circ\text{C}$	P_D	2.0	W
Continuous Drain Current @ $T_A = 25^\circ\text{C}$	I_D	6.5	A
Continuous Drain Current @ $T_A = 70^\circ\text{C}$	I_D	5.5	A
Pulsed Drain Current (Note 4)	I_{DM}	50	A
Thermal Resistance, Junction-to-Ambient (Note 2)	$R_{\theta JA}$	102	$^\circ\text{C}/\text{W}$
Total Power Dissipation @ $T_A = 25^\circ\text{C}$	P_D	1.22	W
Continuous Drain Current @ $T_A = 25^\circ\text{C}$	I_D	5.07	A
Continuous Drain Current @ $T_A = 70^\circ\text{C}$	I_D	4.07	A
Pulsed Drain Current (Note 4)	I_{DM}	40	A
Thermal Resistance Junction-to-Ambient (Note 3)	$R_{\theta JA}$	172	$^\circ\text{C}/\text{W}$
Total Power Dissipation @ $T_A = 25^\circ\text{C}$	P_D	0.73	W
Continuous Drain Current @ $T_A = 25^\circ\text{C}$	I_D	3.92	A
Continuous Drain Current @ $T_A = 70^\circ\text{C}$	I_D	3.14	A
Pulsed Drain Current (Note 4)	I_{DM}	30	A

1. Mounted onto a 2 in square FR-4 Board (1 in sq. 2 oz. Cu 0.06 in thick single sided), $t < 10$ seconds.
2. Mounted onto a 2 in square FR-4 Board (1 in sq. 2 oz. Cu 0.06 in thick single sided), $t =$ steady state.
3. Minimum FR-4 or G-10 PCB, $t =$ steady state.
4. Pulse Test: Pulse Width = 10 μs , Duty Cycle = 2%.



ON Semiconductor®

<http://onsemi.com>

V_{DSS}	$R_{DS(ON)}$ TYP	I_D MAX
20 V	35 m Ω @ $V_{GS} = 4.5$ V	6.0 A

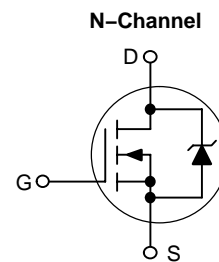

SOIC-8
CASE 751
STYLE 11

MARKING DIAGRAM & PIN ASSIGNMENT

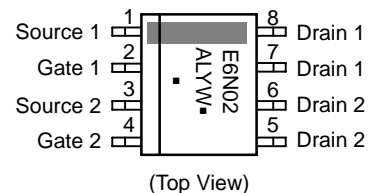

E6N02 = Specific Device Code
A = Assembly Location
Y = Year
WW = Work Week
■ = Pb-Free Package
(Note: Microdot may be in either location)

ORDERING INFORMATION

Device	Package	Shipping†
NTMD6N02R2	SOIC-8	2500/Tape & Reel
NTMD6N02R2G	SOIC-8 (Pb-Free)	2500/Tape & Reel

†For information on tape and reel specifications, including part orientation and tape sizes, please refer to our Tape and Reel Packaging Specification Brochure, BRD8011/D.

NTMD6N02R2

MAXIMUM RATINGS ($T_J = 25^\circ\text{C}$ unless otherwise noted) (continued)

Rating	Symbol	Value	Unit
Operating and Storage Temperature Range	T_J, T_{stg}	-55 to +150	$^\circ\text{C}$
Single Pulse Drain-to-Source Avalanche Energy – Starting $T_J = 25^\circ\text{C}$ ($V_{DD} = 20\text{ Vdc}$, $V_{GS} = 5.0\text{ Vdc}$, Peak $I_L = 6.0\text{ Apk}$, $L = 20\text{ mH}$, $R_G = 25\ \Omega$)	E_{AS}	360	mJ
Maximum Lead Temperature for Soldering Purposes for 10 seconds	T_L	260	$^\circ\text{C}$

ELECTRICAL CHARACTERISTICS ($T_C = 25^\circ\text{C}$ unless otherwise noted) (Note 5)

Characteristic	Symbol	Min	Typ	Max	Unit
----------------	--------	-----	-----	-----	------

OFF CHARACTERISTICS

Drain-to-Source Breakdown Voltage ($V_{GS} = 0\text{ Vdc}$, $I_D = 250\ \mu\text{Adc}$) Temperature Coefficient (Positive)	$V_{(BR)DSS}$	20 –	– 19.2	– –	Vdc mV/ $^\circ\text{C}$
Zero Gate Voltage Drain Current ($V_{DS} = 20\text{ Vdc}$, $V_{GS} = 0\text{ Vdc}$, $T_J = 25^\circ\text{C}$) ($V_{DS} = 20\text{ Vdc}$, $V_{GS} = 0\text{ Vdc}$, $T_J = 125^\circ\text{C}$)	I_{DSS}	– –	– –	1.0 10	μAdc
Gate-Body Leakage Current ($V_{GS} = +12\text{ Vdc}$, $V_{DS} = 0\text{ Vdc}$)	I_{GSS}	–	–	100	nAdc
Gate-Body Leakage Current ($V_{GS} = -12\text{ Vdc}$, $V_{DS} = 0\text{ Vdc}$)	I_{GSS}	–	–	-100	nAdc

ON CHARACTERISTICS

Gate Threshold Voltage ($V_{DS} = V_{GS}$, $I_D = -250\ \mu\text{Adc}$) Temperature Coefficient (Negative)	$V_{GS(th)}$	0.6 –	0.9 -3.0	1.2 –	Vdc mV/ $^\circ\text{C}$
Static Drain-to-Source On-State Resistance ($V_{GS} = 4.5\text{ Vdc}$, $I_D = 6.0\text{ Adc}$) ($V_{GS} = 4.5\text{ Vdc}$, $I_D = 4.0\text{ Adc}$) ($V_{GS} = 2.7\text{ Vdc}$, $I_D = 2.0\text{ Adc}$) ($V_{GS} = 2.5\text{ Vdc}$, $I_D = 3.0\text{ Adc}$)	$R_{DS(on)}$	– – – –	0.028 0.028 0.033 0.035	0.035 0.043 0.048 0.049	Ω
Forward Transconductance ($V_{DS} = 12\text{ Vdc}$, $I_D = 3.0\text{ Adc}$)	g_{FS}	–	10	–	Mhos

DYNAMIC CHARACTERISTICS

Input Capacitance	$(V_{DS} = 16\text{ Vdc}$, $V_{GS} = 0\text{ Vdc}$, $f = 1.0\text{ MHz}$)	C_{iss}	–	785	1100	pF
Output Capacitance		C_{oss}	–	260	450	
Reverse Transfer Capacitance		C_{rss}	–	75	180	

SWITCHING CHARACTERISTICS (Notes 6 and 7)

Turn-On Delay Time	$(V_{DD} = 16\text{ Vdc}$, $I_D = 6.0\text{ Adc}$, $V_{GS} = 4.5\text{ Vdc}$, $R_G = 6.0\ \Omega$)	$t_{d(on)}$	–	12	20	ns
Rise Time		t_r	–	50	90	
Turn-Off Delay Time		$t_{d(off)}$	–	45	75	
Fall Time		t_f	–	80	130	
Turn-On Delay Time	$(V_{DD} = 16\text{ Vdc}$, $I_D = 4.0\text{ Adc}$, $V_{GS} = 4.5\text{ Vdc}$, $R_G = 6.0\ \Omega$)	$t_{d(on)}$	–	11	18	ns
Rise Time		t_r	–	35	65	
Turn-Off Delay Time		$t_{d(off)}$	–	45	75	
Fall Time		t_f	–	60	110	
Total Gate Charge	$(V_{DS} = 16\text{ Vdc}$, $V_{GS} = 4.5\text{ Vdc}$, $I_D = 6.0\text{ Adc}$)	Q_{tot}	–	12	20	nC
Gate-Source Charge		Q_{gs}	–	1.5	–	
Gate-Drain Charge		Q_{gd}	–	4.0	–	

- Handling precautions to protect against electrostatic discharge is mandatory
- Indicates Pulse Test: Pulse Width = 300 μs max, Duty Cycle = 2%.
- Switching characteristics are independent of operating junction temperature.

NTMD6N02R2

ELECTRICAL CHARACTERISTICS ($T_C = 25^\circ\text{C}$ unless otherwise noted) (continued) (Note 8)

Characteristic	Symbol	Min	Typ	Max	Unit	
BODY-DRAIN DIODE RATINGS (Note 9)						
Diode Forward On-Voltage	V_{SD}	-	0.83	1.1	Vdc	
			0.88	1.2		
			0.75	-		
Reverse Recovery Time	t_{rr}	-	30	-	ns	
			t_a	-		-
			t_b	-		-
Reverse Recovery Stored Charge	Q_{RR}	-	0.02	-	μC	

8. Handling precautions to protect against electrostatic discharge is mandatory.

9. Indicates Pulse Test: Pulse Width = 300 μs max, Duty Cycle = 2%.

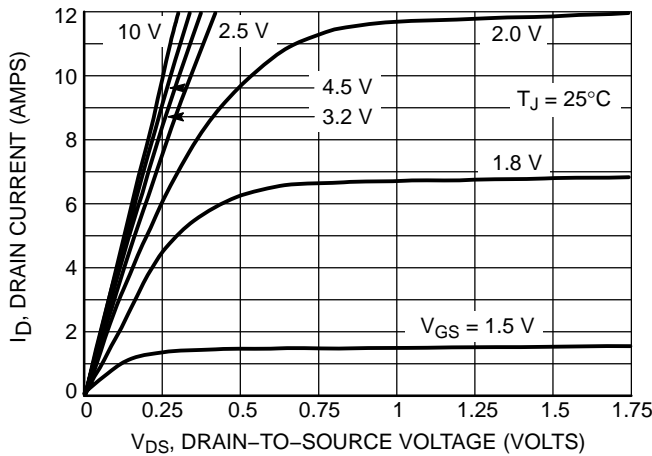

Figure 1. On-Region Characteristics

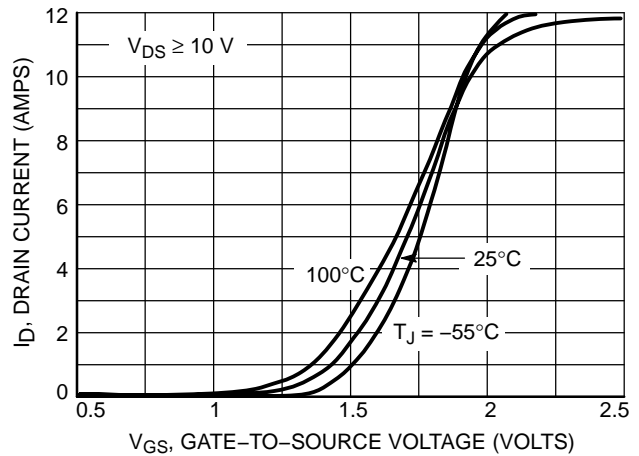

Figure 2. Transfer Characteristics

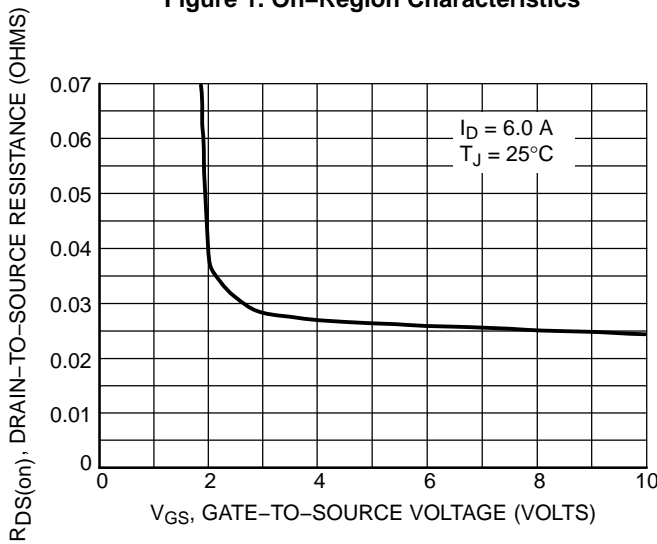

Figure 3. On-Resistance versus Gate-to-Source Voltage

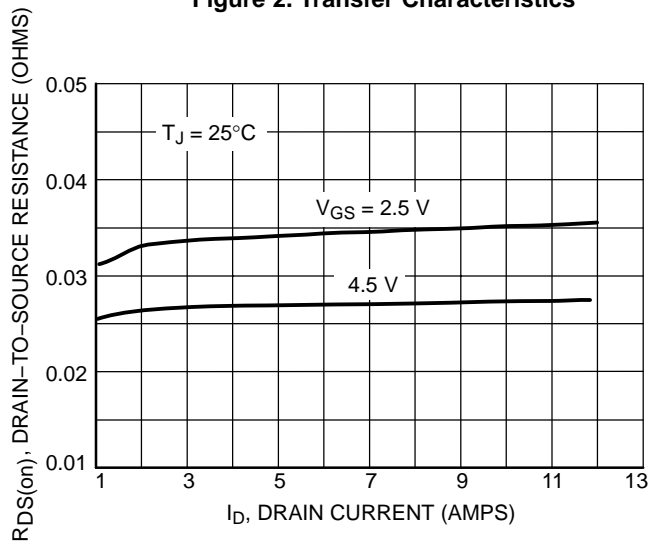

Figure 4. On-Resistance versus Drain Current and Gate Voltage

NTMD6N02R2

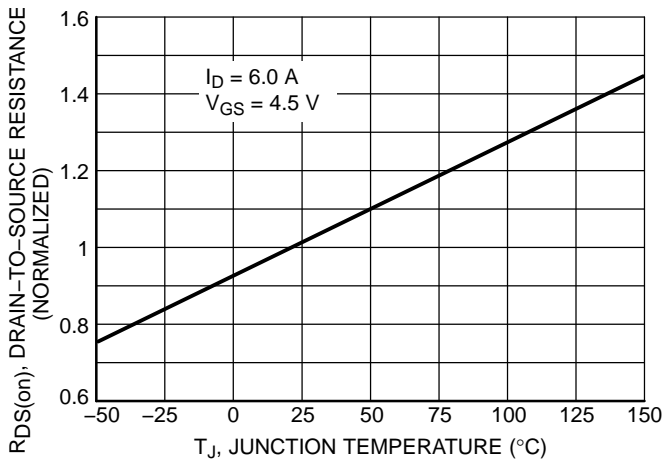

Figure 5. On-Resistance Variation with Temperature

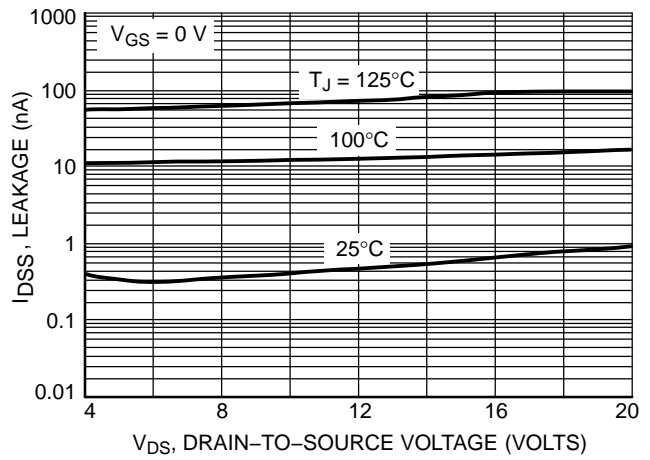

Figure 6. Drain-To-Source Leakage Current versus Voltage

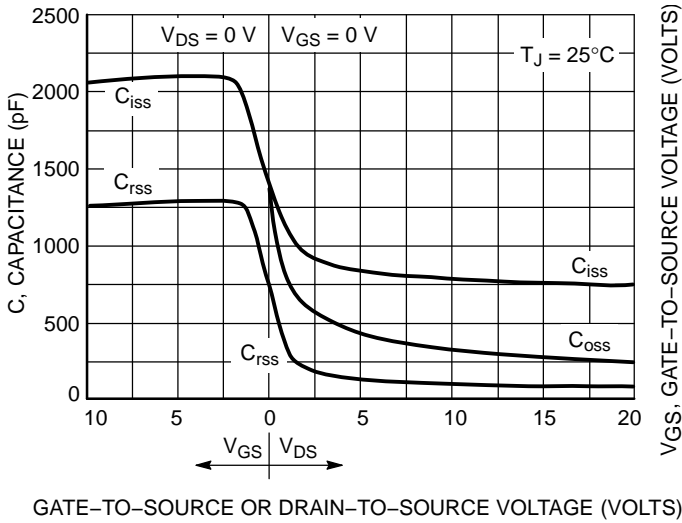

Figure 7. Capacitance Variation

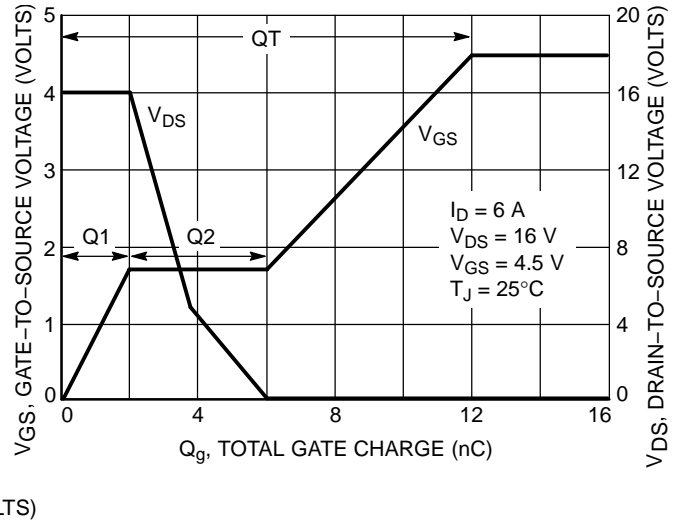

Figure 8. Gate-To-Source and Drain-To-Source Voltage versus Total Charge

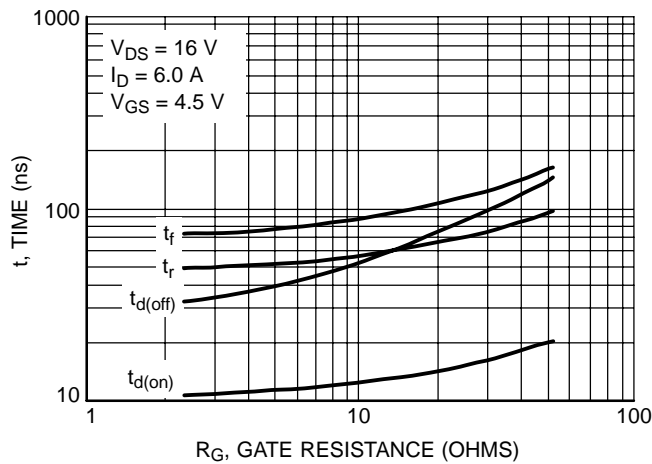

Figure 9. Resistive Switching Time Variation versus Gate Resistance

NTMD6N02R2

DRAIN-TO-SOURCE DIODE CHARACTERISTICS

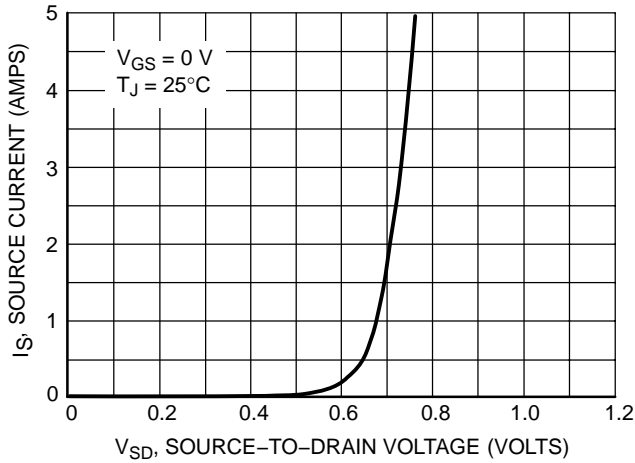

Figure 10. Diode Forward Voltage versus Current

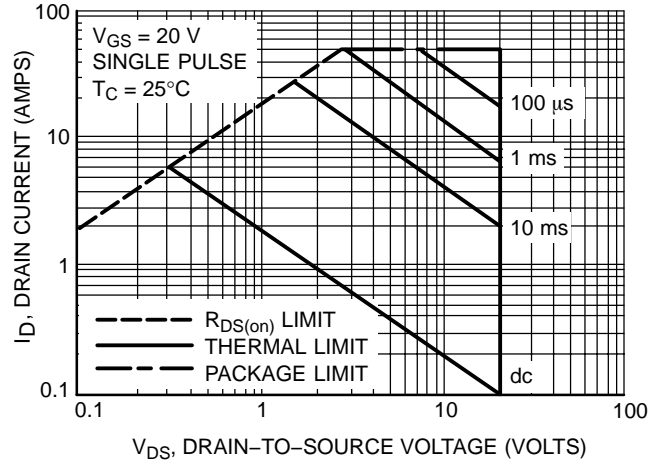

Figure 11. Maximum Rated Forward Biased Safe Operating Area

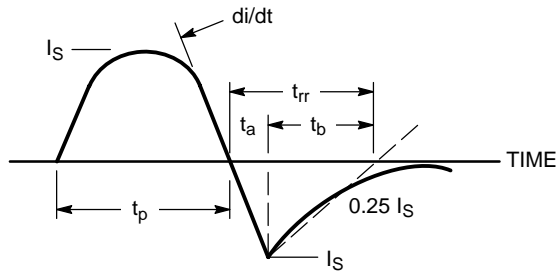

Figure 12. Diode Reverse Recovery Waveform

TYPICAL ELECTRICAL CHARACTERISTICS

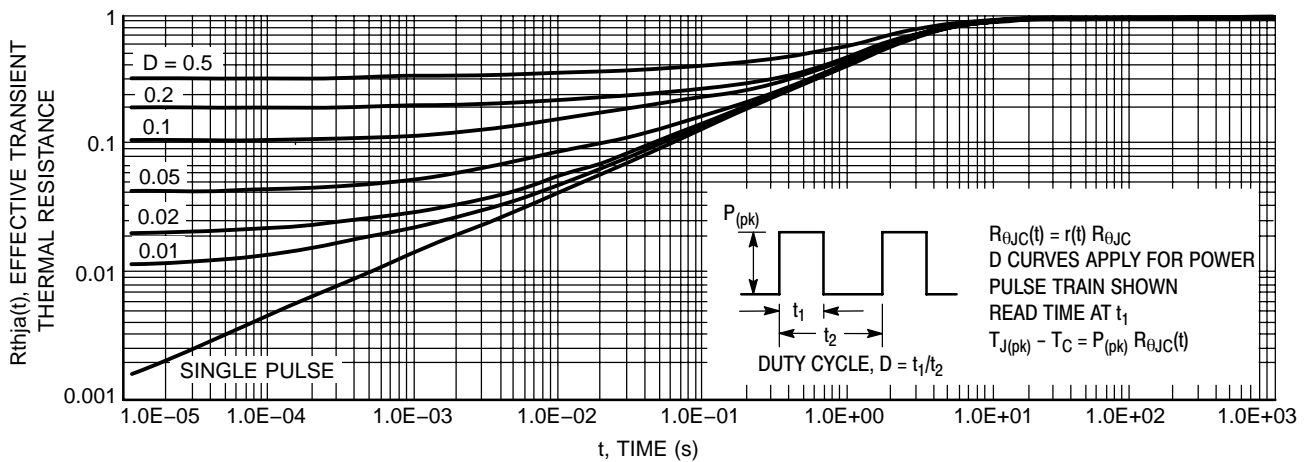
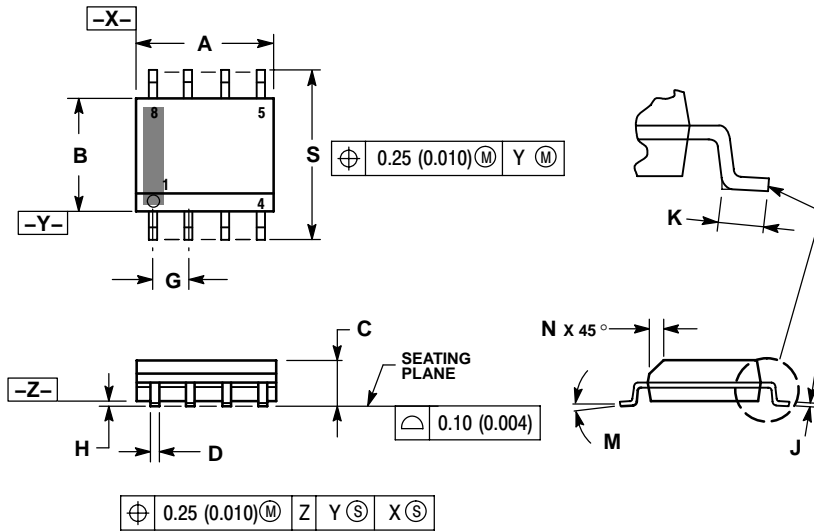

Figure 13. Thermal Response

NTMD6N02R2

PACKAGE DIMENSIONS

SOIC-8
CASE 751-07
ISSUE AG



NOTES:

1. DIMENSIONING AND TOLERANCING PER ANSI Y14.5M, 1982.
2. CONTROLLING DIMENSION: MILLIMETER.
3. DIMENSION A AND B DO NOT INCLUDE MOLD PROTRUSION.
4. MAXIMUM MOLD PROTRUSION 0.15 (0.006) PER SIDE.
5. DIMENSION D DOES NOT INCLUDE DAMBAR PROTRUSION. ALLOWABLE DAMBAR PROTRUSION SHALL BE 0.127 (0.005) TOTAL IN EXCESS OF THE D DIMENSION AT MAXIMUM MATERIAL CONDITION.
6. 751-01 THRU 751-06 ARE OBSOLETE. NEW STANDARD IS 751-07.

DIM	MILLIMETERS		INCHES	
	MIN	MAX	MIN	MAX
A	4.80	5.00	0.189	0.197
B	3.80	4.00	0.150	0.157
C	1.35	1.75	0.053	0.069
D	0.33	0.51	0.013	0.020
G	1.27 BSC		0.050 BSC	
H	0.10	0.25	0.004	0.010
J	0.19	0.25	0.007	0.010
K	0.40	1.27	0.016	0.050
M	0°	8°	0°	8°
N	0.25	0.50	0.010	0.020
S	5.80	6.20	0.228	0.244

STYLE 11:

1. SOURCE 1
2. GATE 1
3. SOURCE 2
4. GATE 2
5. DRAIN 2
6. DRAIN 2
7. DRAIN 1
8. DRAIN 1

SOLDERING FOOTPRINT*

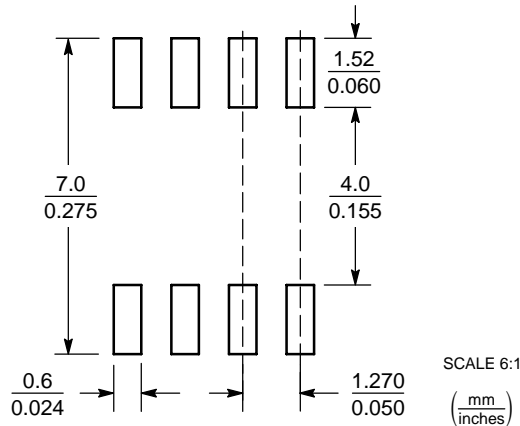

*For additional information on our Pb-Free strategy and soldering details, please download the ON Semiconductor Soldering and Mounting Techniques Reference Manual, SOLDERRM/D.

ON Semiconductor and are registered trademarks of Semiconductor Components Industries, LLC (SCILLC). SCILLC reserves the right to make changes without further notice to any products herein. SCILLC makes no warranty, representation or guarantee regarding the suitability of its products for any particular purpose, nor does SCILLC assume any liability arising out of the application or use of any product or circuit, and specifically disclaims any and all liability, including without limitation special, consequential or incidental damages. "Typical" parameters which may be provided in SCILLC data sheets and/or specifications can and do vary in different applications and actual performance may vary over time. All operating parameters, including "Typicals" must be validated for each customer application by customer's technical experts. SCILLC does not convey any license under its patent rights nor the rights of others. SCILLC products are not designed, intended, or authorized for use as components in systems intended for surgical implant into the body, or other applications intended to support or sustain life, or for any other application in which the failure of the SCILLC product could create a situation where personal injury or death may occur. Should Buyer purchase or use SCILLC products for any such unintended or unauthorized application, Buyer shall indemnify and hold SCILLC and its officers, employees, subsidiaries, affiliates, and distributors harmless against all claims, costs, damages, and expenses, and reasonable attorney fees arising out of, directly or indirectly, any claim of personal injury or death associated with such unintended or unauthorized use, even if such claim alleges that SCILLC was negligent regarding the design or manufacture of the part. SCILLC is an Equal Opportunity/Affirmative Action Employer. This literature is subject to all applicable copyright laws and is not for resale in any manner.

PUBLICATION ORDERING INFORMATION

LITERATURE FULFILLMENT:
Literature Distribution Center for ON Semiconductor
P.O. Box 61312, Phoenix, Arizona 85082-1312 USA
Phone: 480-829-7710 or 800-344-3860 Toll Free USA/Canada
Fax: 480-829-7709 or 800-344-3867 Toll Free USA/Canada
Email: orderlit@onsemi.com

N. American Technical Support: 800-282-9855 Toll Free USA/Canada

Japan: ON Semiconductor, Japan Customer Focus Center
2-9-1 Kamimeguro, Meguro-ku, Tokyo, Japan 153-0051
Phone: 81-3-5773-3850

ON Semiconductor Website: <http://onsemi.com>

Order Literature: <http://www.onsemi.com/litorder>

For additional information, please contact your local Sales Representative.