

.025" SQ SHROUDED HEADER TSSH SERIES

Mates with:
SSW, SSQ, SSM,
ESQ, ESW, BCS

Important Note:
This Series will only mate
with SSW, SSQ &
SSM Series

SPECIFICATIONS

For complete specifications
see www.samtec.com?TSSH

Insulator Material:
Black Liquid Crystal
Polymer



Terminal Material:
Phosphor Bronze

Plating:
Au or Sn over
50µ" (1,27µm) Ni

Operating Temp Range:
-55°C to +105°C with Tin;
-55°C to +125°C with Gold

Processing:
Max Processing Temp:
230°C for 60 seconds, or
260°C for 20 seconds 3x
with Matte Sn

Lead-Free Solderable:
Wave, or reflow with
Matte Sn

SMT Lead Coplanarity:
(0,20mm) .008" max (-DH)
(0,20mm) .008" max (-DV)

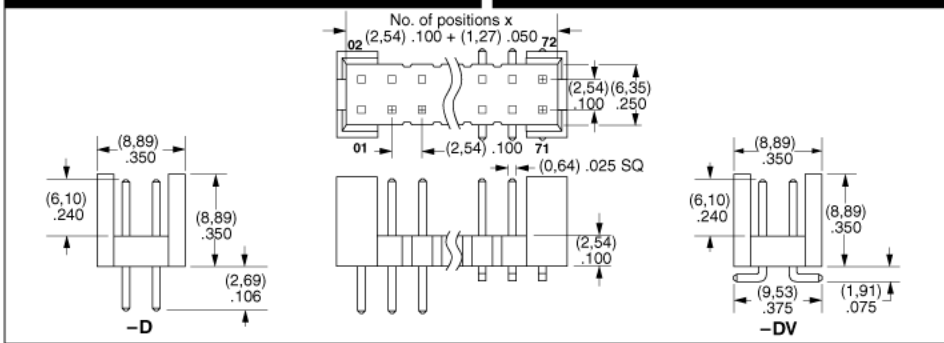
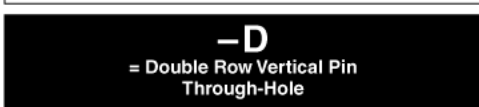
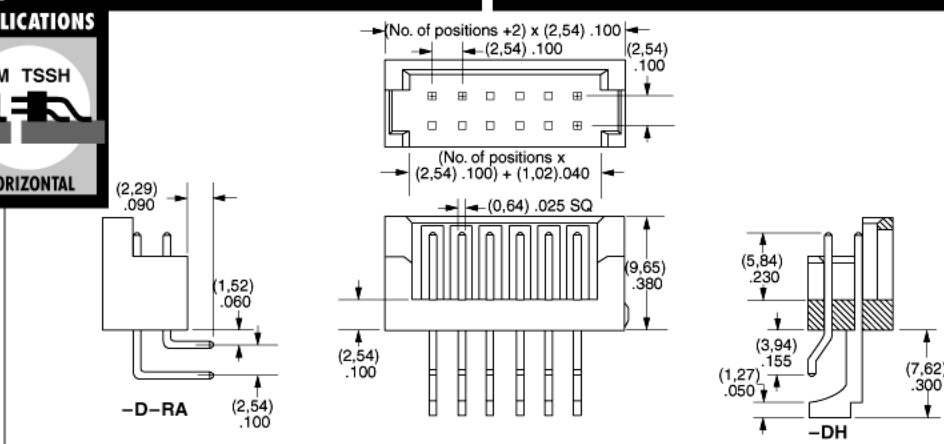
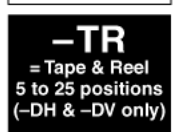
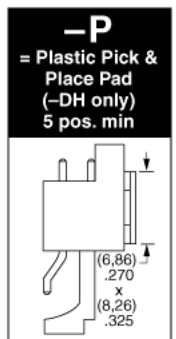
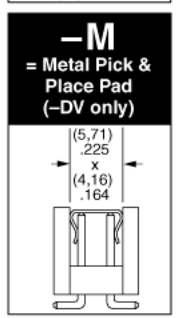
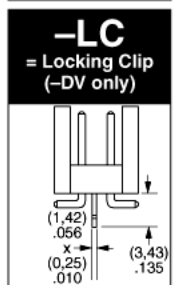
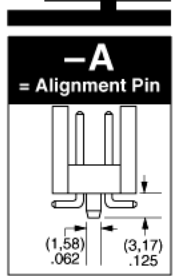
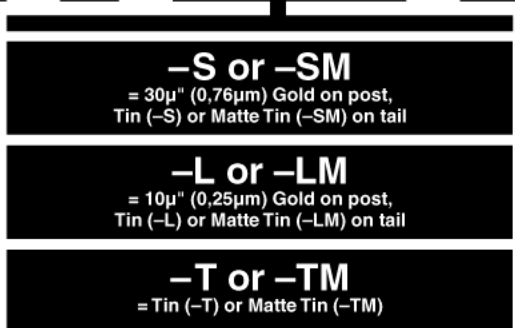
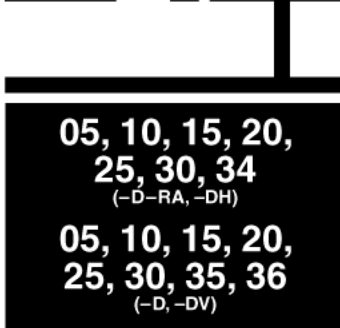

SUGGESTED PCB LAYOUTS

For reference only. Please contact
Samtec or go to www.samtec.com?TSSH for recommended
PCB layout.

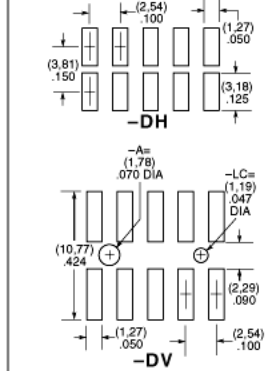

Note: Some lengths,
styles and options are
non-standard, non-returnable.

Due to technical progress, all designs, specifications and components are subject to change without notice.

WWW.SAMTEC.COM