

2297

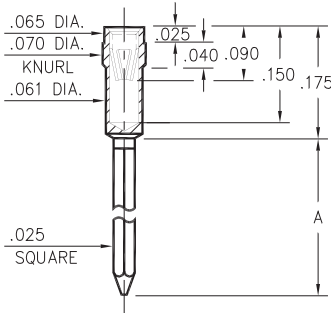

Basic Part Number	# of Wraps	Length A
2297-2	2	.370
2297-3	3	.430

2297-X-17-XX-16-XX-02-0
Press-fit in .067 mounting hole

0280

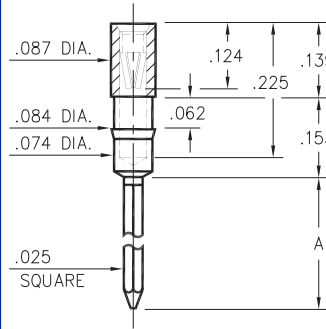

Basic Part Number	# of Wraps	Length A
0280-2	2	.360
0280-3	3	.510

0280-X-17-XX-06-XX-02-0
Press-fit in .081 mounting hole

0281



0281-3-17-XX-06-XX-02-0
Press-fit in .080 mounting hole

SPECIFICATIONS

SHELL MATERIAL:
Brass Alloy 360, 1/2 Hard

CONTACT MATERIAL:
Beryllium Copper Alloy 172, HT

DIMENSION IN INCHES
TOLERANCES ON:
LENGTHS: ±.005
DIAMETERS: ±.002
ANGLES: ± 2°

ORDER CODE: XXXX - X - 17 - XX - XX - XX - 02 - 0

BASIC PART # →

SPECIFY SHELL FINISH:
01 200μ" TIN/LEAD OVER NICKEL
◇ 80 200μ" TIN OVER NICKEL (RoHS)
◇ 15 10μ" GOLD OVER NICKEL (RoHS)

SPECIFY CONTACT FINISH:
01 200μ" TIN/LEAD OVER NICKEL
◇ 80 200μ" TIN OVER NICKEL (RoHS)
◇ 27 30μ" GOLD OVER NICKEL (RoHS)



SELECT CONTACT

#06 or #16 CONTACT (DATA ON PAGES 220 & 221)