



**M57184N-715BF**

NON-ISOLATED DC-DC CONVERTER

**MAXIMUM RATINGS** (unless otherwise noted,  $T_a=25^\circ\text{C}$ )

Symbol	Parameter	Conditions	Ratings	Unit
$V_{in}$	Input voltage	—————	600	V
$I_{L-1}$	Load current-1	—————	350	mA
$I_{L-2}$	Load current-2	—————	200	mA
$T_{opr}$	Operating temperature	No condensation allowable	-20 ~ +70	$^\circ\text{C}$
$T_{stg}$	Storage temperature	No condensation allowable	-25 ~ +85	$^\circ\text{C}$

**ELECTRICAL CHARACTERISTICS** (Unless otherwise noted,  $T_a=25^\circ\text{C}$ ,  $V_{in}=280\text{V}$ )

Symbol	Parameter	Conditions	Limits			Unit
			Min	Typ	Max	
$V_{in}$	Input voltage	Recommended range	220	280	360	V
$V_{O-1}$	Output voltage - 1	Pin 10 voltage: $I_{L-1} = 350\text{mA}$	14.1	15.0	15.9	V
$V_{O-2}$	Output voltage - 2	Pin 18 voltage: $I_{L-2} = 200\text{mA}$	4.7	5.0	5.3	V
$Reg_{-i1}$	Input regulation - 1	Pin 10 voltage: $I_{L-1} = 350\text{mA}$ , $V_{in} = 220 \sim 360\text{V}$	—	60	160	mV
$Reg_{-i2}$	Input regulation - 2	Pin 18 voltage: $I_{L-2} = 200\text{mA}$ , $V_{in} = 220 \sim 360\text{V}$	—	60	160	mV
$Reg_{-L1}$	Load regulation - 1	Pin 10 voltage: $I_{L-1} = 0 \sim 350\text{mA}$	—	80	200	mV
$Reg_{-L2}$	Load regulation - 2	Pin 18 voltage: $I_{L-2} = 0 \sim 200\text{mA}$	—	80	200	mV
$\eta$	Efficiency	$I_{L-1} = 350\text{mA}$ , $I_{L-2} = 200\text{mA}$	65	72	—	%
$V_{P-P}$	Ripple voltage	$I_{L-1} = 350\text{mA}$ , $I_{L-2} = 200\text{mA}$ (*1)	—	80	200	mVp-p

(\*1) Spike noise is not included in output ripple voltage.

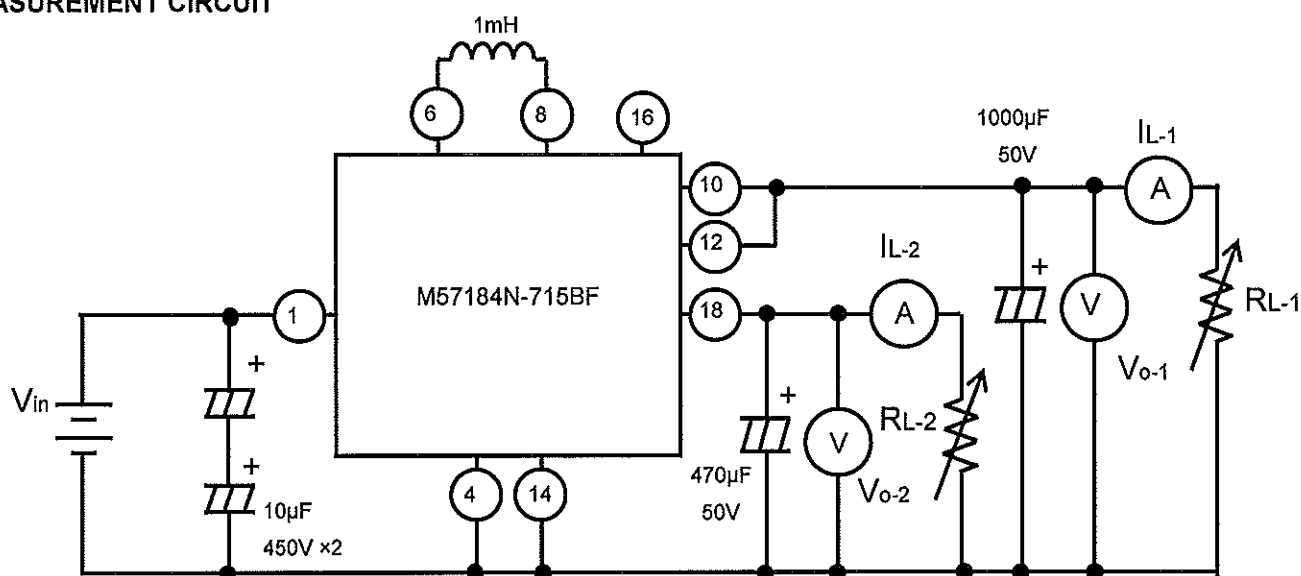
**MEASUREMENT CIRCUIT**

(\*) Please use power inductors with good performance of DC superimposition.

(We used C13 -FR -102: made in MITSUMI ELECTRIC CO., LTD.)

(\*\*) Please use electrolytic capacitor of output side with high frequency and low impedance.

(\*\*\*) Since a 16Pin is a test terminal, please use it for opening, carrying out it electrically.

**TYPICAL CHARACTERISTICS**

OUTPUT VOLTAGE - INPUT VOLTAGE CHARACTERISTICS (TYPICAL)

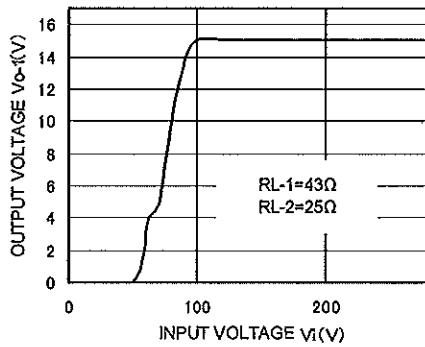

OUTPUT VOLTAGE - LOAD CURRENT CHARACTERISTICS (TYPICAL)

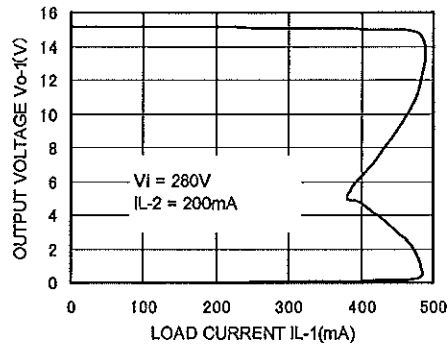

OUTPUT VOLTAGE - LOAD CURRENT CHARACTERISTICS (TYPICAL)

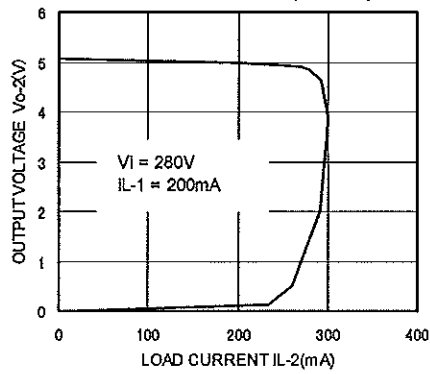

START-UP CHARACTERISTICS (TYPICAL)

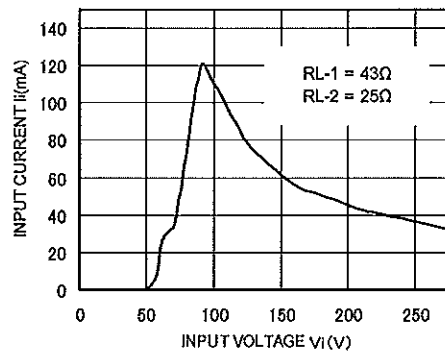

START-UP CHARACTERISTICS (TYPICAL)

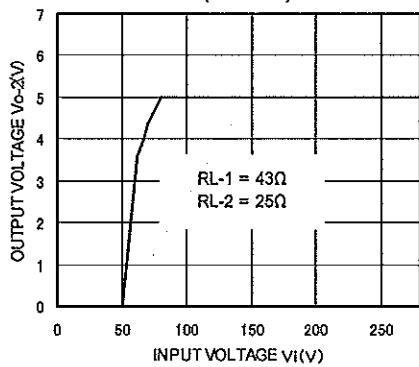

EFFICIENCY - LOAD CURRENT CHARACTERISTICS (TYPICAL)

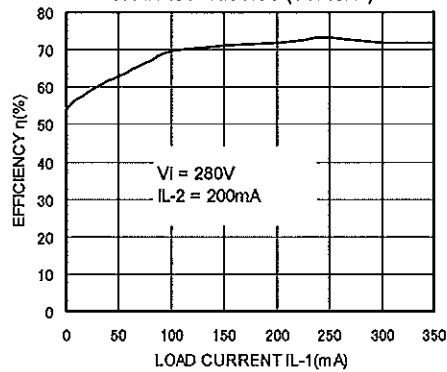

EFFICIENCY - INPUT VOLTAGE CHARACTERISTICS (TYPICAL)

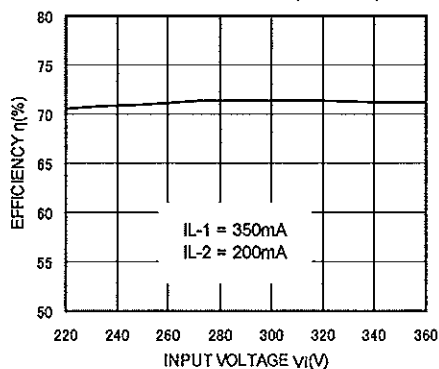

DERATING CURVE

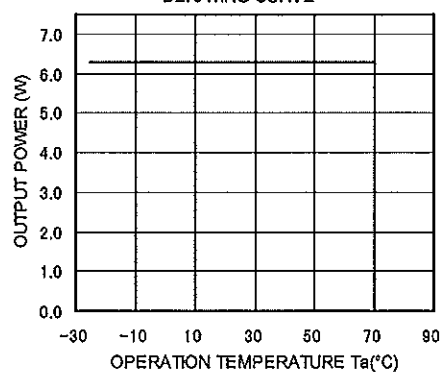

**FOR SAFETY USING**

Great detail and careful attention are given to the production activity of Hics, such as the development, the quality of production, and in its reliability. However the reliability of Hics depends not only on their own factors but also in their condition of usage. When handling Hics, please note the following cautions.

CAUTIONS	
Packing	<p>The materials used in packing Hics can only withstand normal external conditions. When exposed to outside shocks, rain and certain environmental contaminants, the packing materials will deteriorate. Please take care in handling.</p>
Carrying	<ol style="list-style-type: none"> <li>1) Don't stack boxes too high. Avoid placing heavy materials on boxes.</li> <li>2) Boxes must be positioned correctly during transportation to avoid breakage.</li> <li>3) Don't throw or drop boxes.</li> <li>4) Keep boxes dry. Avoid rain or snow.</li> <li>5) Minimal vibration and shock during transportation is desirable.</li> </ol>
Storage	<p>When storing Hics, please observe the following notices or possible deterioration of their electrical characteristics, risk of solderability, and external damage may occur.</p> <ol style="list-style-type: none"> <li>1) Devices must be stored where fluctuation of temperature and humidity is minimal, and must not be exposed to direct sunlight. Store at the normal temperature of 5 to 30 degrees Celsius with humidity at 40 to 60%.</li> <li>2) Avoid locations where corrosive gasses are generated or where much dust accumulates.</li> <li>3) Storage cases must be static proof.</li> <li>4) Avoid putting weight on boxes.</li> </ol>
Extended storage	<p>When extended storage is necessary, Hics must be kept non-processed. When using Hics which have been stored for more than one year or under severe conditions, be sure to check that the exterior is free from flaw and other damages.</p>
Maximum ratings	<p>To prevent any electrical damages, use Hics within the maximum ratings. The temperature, current, voltage, etc. must not exceed these conditions.</p>
Polarity	<p>To protect Hics from destruction and deterioration due to wrong insertion, make sure of polarity in inserting leads into the board holes, conforming to the external view for the terminal arrangement.</p>

**ISAHAYA ELECTRONICS CORPORATION**

Marketing division, Marketing planning department

6-41 Tsukuba, Isahaya, Nagasaki, 854-0065 Japan

**Keep safety first in your circuit designs!**

- ISAHAYA Electronics Corporation puts the maximum effort into making semiconductor products better and more reliable, but there is always the possibility that trouble may occur with them. Trouble with semiconductors may lead to personal injury, fire or property damage. Remember to give due consideration to safety when making your circuit designs, with appropriate measures such as (1)placement of substitutive, auxiliary circuits, (2)use of non-flammable material or (3)prevention against any malfunction or mishap.

**Notes regarding these materials**

- These materials are intended as a reference to assist our customers in the selection of the ISAHAYA products best suited to the customer's application; they don't convey any license under any intellectual property rights, or any other rights, belonging ISAHAYA or a third party.
- ISAHAYA Electronics Corporation assumes no responsibility for any damage, or infringement of any third party's rights, originating in the use of any product data, diagrams, charts or circuit application examples contained in these materials.
- All information contained in these materials, including product data, diagrams and charts, represent information on products at the time of publication of these materials, and are subject to change by ISAHAYA Electronics Coporation without notice due to product improvements or other reasons. It is therefore recommended that customers contact ISAHAYA Electronics Corporation or an authorized ISAHAYA products distributor for the latest product infomation before purchasing product listed herein.
- ISAHAYA Electronics Corporation products are not designed or manufactured for use in a device or system that is used under circumstances in which human life is potentially at stake. Please contact ISAHAYA electronics corporation or an authorized ISAHAYA products distributor when considering the use of a product contained herein for any specific purposes, such as apparatus or systems for transportation, vehicular, medical, aerospace, nuclear, or undersea repeater use.
- The prior written approval of ISAHAYA Electronics Corporation is necessary to reprint or reproduce in whole or in part these materials.
- If these products or technologies are subject to the Japanese export control restrictions, they must be exported under a liscence from the Japanese government and cannot be imported into a country other than the approved destination. Any diversion or reexport contrary to the export control laws and regulations of Japan and/or the country of destination is prohibited.
- Please contact ISAHAYA Electronics Corporation or an authorized ISAHAYA products distributor for further details on these materials or the products contained therein.