

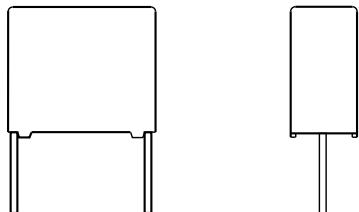

Interference Suppression Film Capacitors MKP Radial Potted Type



FEATURES

- 7.5 mm to 27.5 mm lead pitch
- Supplied loose in box, taped on ammpack or reel
- Material categorization: For definitions of compliance please see www.vishay.com/doc?99912



RoHS
COMPLIANT

APPLICATIONS

For standard across the line X2 applications.

See also application note: www.vishay.com/doc?28153

| QUICK REFERENCE DATA | |
|---|--|
| Capacitance range (E12 series) | E12 series 0.001 μ F to 4.7 μ F Preferred values acc. to E6 |
| Capacitance tolerance | $\pm 20\%$; $\pm 10\%$; ($\pm 5\%$ on request) |
| Rated AC voltage | 310 V _{AC} ; 50 Hz to 60 Hz |
| Permissible DC voltage | 800 V _{DC} at 85 °C 630 V _{DC} at 110 °C |
| Climatic testing class according to IEC 60068-1 | 55/110/56/B for volumes > 1750 mm ³ 55/110/56/C for volumes \leq 1750 mm ³ |
| Maximum application temperature | C \leq 470 nF: 110 °C (125 °C for less than 1000 h) C > 470 nF: 110 °C |
| Reference standards | IEC 60384-14 and EN 60384-14 IEC 60065, pass. flamm. class B for volumes > 1750 mm ³ CSA-E384-14; CQC UL 60384-14 |
| Dielectric | Polypropylene film |
| Electrodes | Metallized film |
| Construction | Mono construction  |
| Encapsulation | Plastic case, epoxy resin sealed, flame retardant class UL 94 V-0 |
| Leads | Tinned wire |
| Marking | C-value; tolerance; rated voltage; sub-class; manufacturer's type; code for dielectric material; manufacturer location; manufacturer's logo; year and week; safety approvals |

Notes

- For more detailed data and test requirements, contact rfi@vishay.com

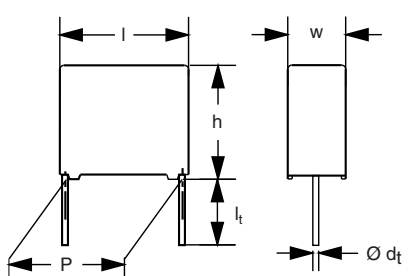
| DIMENSIONS in millimeters |
|--|
|  |



COMPOSITION OF CATALOG NUMBER

The new RFI Film Capacitor Code is made up 14 digit code (example)

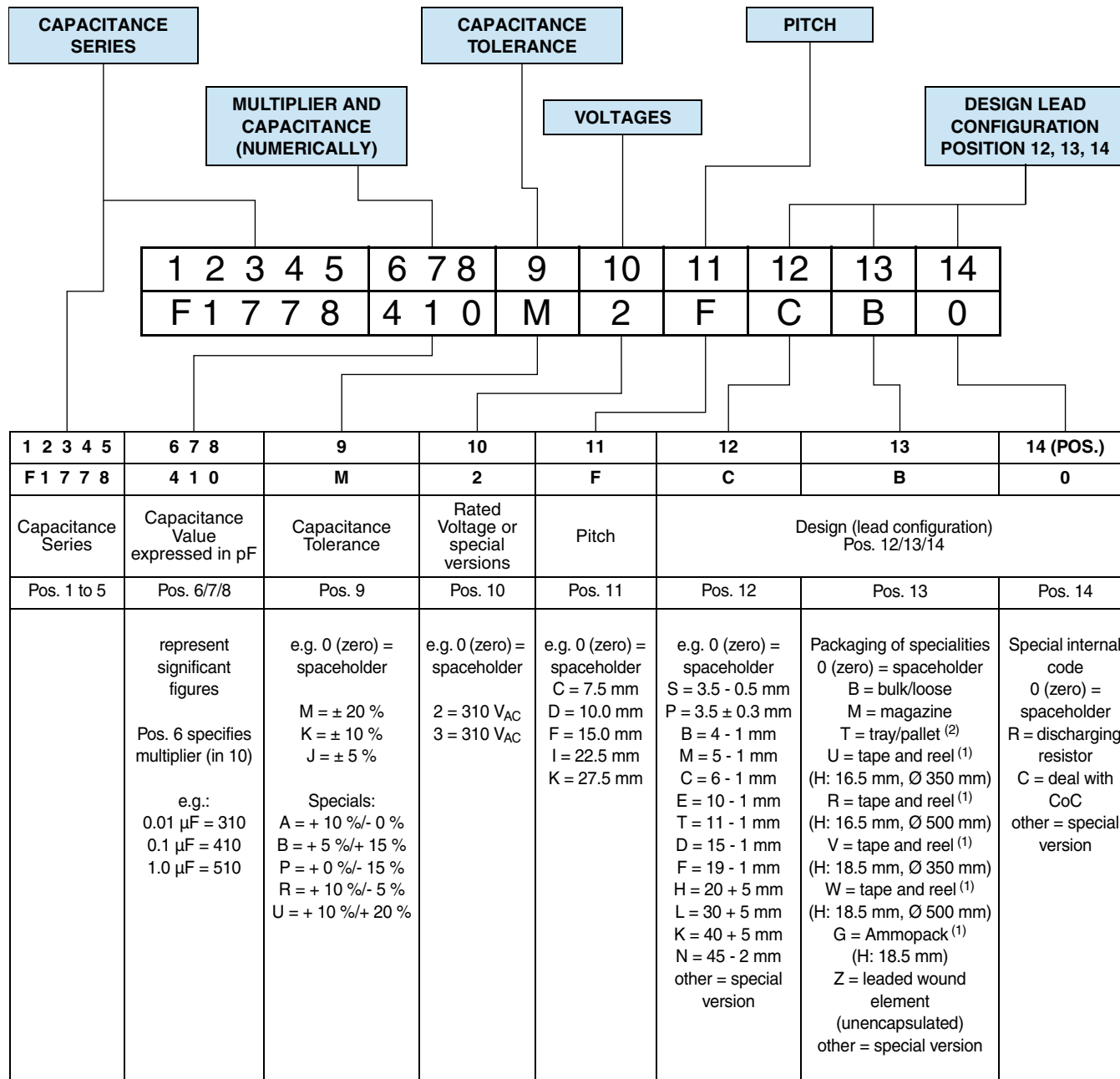

Notes

- (1) For detailed tape specification refer to packaging information: www.vishay.com/doc?28139
- (2) Packaging will be bulk for all capacitors with pitch ≤ 15 mm with bulk and tray packing



| SPECIFIC REFERENCE DATA | | |
|--|----------------------------------|--------------------------|
| DESCRIPTION | VALUE | |
| Rated AC voltage (U_{RAC}) | 310 V | |
| Permissible DC voltage (U_{RDC}) | 630 V | |
| Tangent of loss angle: | at 1 kHz | at 10 kHz |
| $C < 470 \text{ nF}$ | $\leq 10 \times 10^{-4}$ | $\leq 20 \times 10^{-4}$ |
| $470 \text{ nF} \leq C \leq 1 \mu\text{F}$ | $\leq 20 \times 10^{-4}$ | $\leq 70 \times 10^{-4}$ |
| $C > 1 \mu\text{F}$ | $\leq 30 \times 10^{-4}$ | - |
| Rated voltage pulse slope (dU/dt) _R at 435 V _{DC} | 600 V/ μs | |
| Pitch = 7.5 mm | 600 V/ μs | |
| Pitch = 10 mm | 400 V/ μs | |
| Pitch = 15 mm | 150 V/ μs | |
| Pitch = 22.5 mm | 100 V/ μs | |
| Pitch = 27.5 mm | > 15 000 M Ω | |
| R between leads, for $C \leq 0.33 \mu\text{F}$ at 100 V; 1 min | > 5000 s | |
| RC between leads, for $C > 0.33 \mu\text{F}$ at 100 V; 1 min | > 30 000 M Ω | |
| R between leads and case; 100 V; 1 min | 2200 V; 1 min | |
| Withstanding (DC) voltage (cut off current 10 mA) ⁽¹⁾ ; rise time $1000 \leq V/s$: | 1800 V; 1 min | |
| $C \leq 1 \mu\text{F}$ | 2120 V; 1 min | |
| $C > 1 \mu\text{F}$ | 2120 V; 1 min | |
| Withstanding (AC) voltage between leads and case | 110 °C (125 °C less than 1000 h) | |
| Max. application temperature for $0.001 \mu\text{F} \leq C \leq 0.47 \mu\text{F}$ | 110 °C | |
| Max. application temperature for $C > 0.47 \mu\text{F}$ | 110 °C | |

Note

⁽¹⁾ See "Voltage Proof Test for Metallized Film Capacitors": www.vishay.com/doc?28169

| ELECTRICAL DATA AND ORDERING CODE | | | | | | | | | | | |
|-----------------------------------|--|--|---|----------------------------|--|------------------------------|---------|------|---------|-------|--------------------------|
| U_{RAC} (V) | CAP. μF POS. 6 TO 8 | TOLERANCE CODE POS. 9 J = $\pm 5\%$ K = $\pm 10\%$ M = $\pm 20\%$ | DIMENSIONS MAX. w x h x l (mm) | MASS (g) ⁽³⁾ | SPQ ⁽⁴⁾ SHORT LEADS (PIECES) | ORDERING CODE ⁽²⁾ | | | | | |
| | | | | | | TYPE | C-VALUE | TOL. | VOLTAGE | PITCH | LEAD LENGTH DESIGN |
| | | | | | | 1 TO 5 | 6 TO 8 | 9 | 10 | 11 | 12 TO 14 ⁽¹⁾ |
| 310 | PITCH 7.5 mm \pm 0.4 mm; $d_t = 0.50 \text{ mm} \pm 0.05 \text{ mm}$ | | | | | | | | | | |
| | 0.0010 | K/M | 4.0 x 9.0 x 10.0 | 0.45 | 1500 | F1778 | 210 | . | . | C | ..0 |
| | 0.0012 | K | 4.0 x 9.0 x 10.0 | 0.45 | 1500 | F1778 | 212 | K | . | C | ..0 |
| | 0.0015 | K/M | 4.0 x 9.0 x 10.0 | 0.45 | 1500 | F1778 | 215 | . | . | C | ..0 |
| | 0.0018 | K | 4.0 x 9.0 x 10.0 | 0.45 | 1500 | F1778 | 218 | K | . | C | ..0 |
| | 0.0022 | K/M | 4.0 x 9.0 x 10.0 | 0.45 | 1500 | F1778 | 222 | . | . | C | ..0 |
| | 0.0027 | K | 4.0 x 9.0 x 10.0 | 0.45 | 1500 | F1778 | 227 | K | . | C | ..0 |
| | 0.0033 | K/M | 4.0 x 9.0 x 10.0 | 0.45 | 1500 | F1778 | 233 | . | . | C | ..0 |
| | 0.0039 | K | 4.0 x 9.0 x 10.0 | 0.45 | 1500 | F1778 | 239 | K | . | C | ..0 |
| | 0.0047 | K/M | 4.0 x 9.0 x 10.0 | 0.45 | 1500 | F1778 | 247 | . | . | C | ..0 |
| | 0.0056 | K | 4.0 x 9.0 x 10.0 | 0.45 | 1500 | F1778 | 256 | K | . | C | ..0 |
| | 0.0068 | K/M | 4.0 x 9.0 x 10.0 | 0.45 | 1500 | F1778 | 268 | . | . | C | ..0 |
| | 0.0082 | K | 4.0 x 9.0 x 10.0 | 0.45 | 1500 | F1778 | 282 | K | . | C | ..0 |
| | 0.010 | K/M | 4.0 x 9.0 x 10.0 | 0.45 | 1500 | F1778 | 310 | . | . | C | ..0 |
| | 0.012 | K | 4.0 x 9.0 x 10.0 | 0.45 | 1500 | F1778 | 312 | K | . | C | ..0 |
| | 0.015 | K/M | 4.0 x 9.0 x 10.0 | 0.45 | 1500 | F1778 | 315 | . | . | C | ..0 |
| | 0.018 | K | 4.0 x 9.0 x 10.0 | 0.45 | 1500 | F1778 | 318 | K | . | C | ..0 |
| | 0.022 | K/M | 4.0 x 9.0 x 10.0 | 0.45 | 1500 | F1778 | 322 | . | . | C | ..0 |
| | 0.027 | K | 4.0 x 9.0 x 10.0 | 0.45 | 1500 | F1778 | 327 | K | . | C | ..0 |
| | 0.033 | K | 5.0 x 10.5 x 10.0 | 0.6 | 1000 | F1778 | 333 | K | . | C | ..0 |
| 0.033 | M | 4.0 x 9.0 x 10.0 | 0.45 | 1500 | F1778 | 333 | M | . | C | ..0 | |
| 0.039 | K | 5.0 x 10.5 x 10.0 | 0.6 | 1000 | F1778 | 339 | K | . | C | ..0 | |
| 0.047 | K | 5.0 x 10.5 x 10.0 | 0.6 | 1000 | F1778 | 347 | K | . | C | ..0 | |
| 0.047 | M | 5.0 x 10.5 x 10.0 | 0.4 | 1000 | F1778 | 347 | M | . | C | ..0 | |
| 0.056 | K | 6.0 x 11.5 x 10.0 | 0.8 | 750 | F1778 | 356 | K | . | C | ..0 | |
| 0.068 | M | 6.0 x 11.5 x 10.0 | 0.8 | 750 | F1778 | 368 | M | . | C | ..0 | |



| ELECTRICAL DATA AND ORDERING CODE | | | | | | | | | | | | |
|-----------------------------------|--|--|---|----------------------------|--|------------------------------|---------|------|---------|-------|--------------------------|--|
| U _{RAC} (V) | CAP. μF POS. 6 TO 8 | TOLERANCE CODE POS. 9 J = ± 5 % K = ± 10 % M = ± 20 % | DIMENSIONS MAX. w x h x l (mm) | MASS (g) ⁽³⁾ | SPQ ⁽⁴⁾ SHORT LEADS (PIECES) | ORDERING CODE ⁽²⁾ | | | | | | |
| | | | | | | TYPE | C-VALUE | TOL. | VOLTAGE | PITCH | LEAD LENGTH DESIGN | |
| | | | | | | 1 TO 5 | 6 TO 8 | 9 | 10 | 11 | 12 TO 14 ⁽¹⁾ | |
| 310 | PITCH 10 mm ± 0.4 mm; d _t = 0.60 mm ± 0.06 mm | | | | | | | | | | | |
| | 0.0010 | K/M | 4.0 x 10.0 x 12.5 | 0.6 | 1500 | F1778 | 210 | . | . | D | ..0 | |
| | 0.0012 | K | 4.0 x 10.0 x 12.5 | 0.6 | 1500 | F1778 | 212 | K | . | D | ..0 | |
| | 0.0015 | K/M | 4.0 x 10.0 x 12.5 | 0.6 | 1500 | F1778 | 215 | . | . | D | ..0 | |
| | 0.0018 | K | 4.0 x 10.0 x 12.5 | 0.6 | 1500 | F1778 | 218 | K | . | D | ..0 | |
| | 0.0022 | K/M | 4.0 x 10.0 x 12.5 | 0.6 | 1500 | F1778 | 222 | . | . | D | ..0 | |
| | 0.0027 | K | 4.0 x 10.0 x 12.5 | 0.6 | 1500 | F1778 | 227 | K | . | D | ..0 | |
| | 0.0033 | K/M | 4.0 x 10.0 x 12.5 | 0.6 | 1500 | F1778 | 233 | . | . | D | ..0 | |
| | 0.0039 | K | 4.0 x 10.0 x 12.5 | 0.6 | 1500 | F1778 | 239 | K | . | D | ..0 | |
| | 0.0047 | K/M | 4.0 x 10.0 x 12.5 | 0.6 | 1500 | F1778 | 247 | . | . | D | ..0 | |
| | 0.0056 | K | 4.0 x 10.0 x 12.5 | 0.6 | 1500 | F1778 | 256 | K | . | D | ..0 | |
| | 0.0068 | K/M | 4.0 x 10.0 x 12.5 | 0.6 | 1500 | F1778 | 268 | . | . | D | ..0 | |
| | 0.0082 | K | 4.0 x 10.0 x 12.5 | 0.6 | 1500 | F1778 | 282 | K | . | D | ..0 | |
| | 0.010 | K/M | 4.0 x 10.0 x 12.5 | 0.6 | 1500 | F1778 | 310 | . | . | D | ..0 | |
| | 0.012 | K | 4.0 x 10.0 x 12.5 | 0.6 | 1500 | F1778 | 312 | K | . | D | ..0 | |
| | 0.015 | K/M | 4.0 x 10.0 x 12.5 | 0.6 | 1500 | F1778 | 315 | . | . | D | ..0 | |
| | 0.018 | K | 4.0 x 10.0 x 12.5 | 0.6 | 1250 | F1778 | 318 | K | . | D | ..0 | |
| | 0.022 | K/M | 4.0 x 10.0 x 12.5 | 0.6 | 1250 | F1778 | 322 | . | . | D | ..0 | |
| | 0.027 | K | 4.0 x 10.0 x 12.5 | 0.6 | 1250 | F1778 | 327 | K | . | D | ..0 | |
| | 0.033 | K/M | 4.0 x 10.0 x 12.5 | 0.6 | 1000 | F1778 | 333 | . | . | D | ..0 | |
| | 0.039 | K | 4.0 x 10.0 x 12.5 | 0.6 | 1000 | F1778 | 339 | K | . | D | ..0 | |
| | 0.047 | K | 4.0 x 10.0 x 12.5 | 0.6 | 750 | F1778 | 347 | K | . | D | ..0 | |
| | 0.047 | M | 4.0 x 10.0 x 12.5 | 0.6 | 1000 | F1778 | 347 | M | . | D | ..0 | |
| | 0.056 | K | 5.0 x 11.0 x 12.5 | 0.82 | 1000 | F1778 | 356 | K | . | D | ..0 | |
| | 0.068 | K/M | 5.0 x 11.0 x 12.5 | 0.82 | 750 | F1778 | 368 | . | . | D | ..0 | |
| | 0.082 | K | 6.0 x 12.0 x 12.5 | 1.10 | 750 | F1778 | 382 | K | . | D | ..0 | |
| | 0.100 | K/M | 6.0 x 12.0 x 12.5 | 1.10 | 750 | F1778 | 410 | . | . | D | ..0 | |
| | PITCH 15 mm ± 0.4 mm; d _t = 0.60 mm ± 0.06 mm | | | | | | | | | | | |
| | 0.010 | K/M | 5.0 x 11.0 x 17.5 | 1.0 | 750 | F1778 | 310 | . | . | F | ..0 | |
| | 0.012 | K | 5.0 x 11.0 x 17.5 | 1.0 | 750 | F1778 | 312 | K | . | F | ..0 | |
| | 0.015 | K/M | 5.0 x 11.0 x 17.5 | 1.0 | 750 | F1778 | 315 | . | . | F | ..0 | |
| | 0.018 | K | 5.0 x 11.0 x 17.5 | 1.0 | 750 | F1778 | 318 | K | . | F | ..0 | |
| | 0.022 | K/M | 5.0 x 11.0 x 17.5 | 1.0 | 750 | F1778 | 322 | . | . | F | ..0 | |
| | 0.027 | K | 5.0 x 11.0 x 17.5 | 1.0 | 750 | F1778 | 327 | K | . | F | ..0 | |
| | 0.033 | K/M | 5.0 x 11.0 x 17.5 | 1.0 | 750 | F1778 | 333 | . | . | F | ..0 | |
| | 0.039 | K | 5.0 x 11.0 x 17.5 | 1.0 | 750 | F1778 | 339 | K | . | F | ..0 | |
| | 0.047 | K/M | 5.0 x 11.0 x 17.5 | 1.0 | 750 | F1778 | 347 | . | . | F | ..0 | |
| | 0.056 | K | 5.0 x 11.0 x 17.5 | 1.0 | 750 | F1778 | 356 | K | . | F | ..0 | |
| | 0.068 | K/M | 5.0 x 11.0 x 17.5 | 1.0 | 750 | F1778 | 368 | . | . | F | ..0 | |
| | 0.082 | K | 5.0 x 11.0 x 17.5 | 1.0 | 750 | F1778 | 382 | K | . | F | ..0 | |
| | 0.10 | K | 5.0 x 11.0 x 17.5 | 1.0 | 600 | F1778 | 410 | K | . | F | ..0 | |
| | 0.10 | M | 5.0 x 11.0 x 17.5 | 1.0 | 750 | F1778 | 410 | M | . | F | ..0 | |
| | 0.12 | K | 6.0 x 12.0 x 17.5 | 1.4 | 600 | F1778 | 412 | K | . | F | ..0 | |
| | 0.15 | K | 6.0 x 12.0 x 17.5 | 1.4 | 450 | F1778 | 415 | K | . | F | ..0 | |
| | 0.15 | M | 6.0 x 12.0 x 17.5 | 1.4 | 600 | F1778 | 415 | M | . | F | ..0 | |
| | PITCH 15 mm ± 0.4 mm; d _t = 0.80 mm ± 0.08 mm | | | | | | | | | | | |
| | 0.18 | K | 7.0 x 13.5 x 17.5 | 1.8 | 450 | F1778 | 418 | K | . | F | ..0 | |
| | 0.22 | K/M | 7.0 x 13.5 x 17.5 | 1.8 | 300 | F1778 | 422 | . | . | F | ..0 | |
| 0.27 | K | 8.5 x 15.0 x 17.5 | 2.4 | 240 | F1778 | 427 | K | . | F | ..0 | | |
| 0.33 | K/M | 8.5 x 15.0 x 17.5 | 2.4 | 240 | F1778 | 433 | . | . | F | ..0 | | |
| 0.39 | K | 10.0 x 16.5 x 17.5 | 3 | 225 | F1778 | 439 | K | . | F | ..0 | | |
| 0.47 | K/M | 10.0 x 16.5 x 17.5 | 3 | 225 | F1778 | 447 | . | . | F | ..0 | | |
| 0.56 | K/M | 10.0 x 18.5 x 18.0 | 4.3 | 225 | F1778 | 456 | . | . | F | ..0 | | |
| 0.68 | M | 11.0 x 18.5 x 18.0 | 5.5 | 225 | F1778 | 468 | M | . | F | ..0 | | |





| ELECTRICAL DATA AND ORDERING CODE | | | | | | | | | | | | |
|--|--|--|---|----------------------------|--|------------------------------|---------|------|---------|-------|--------------------------|-----|
| U _{RAC} (V) | CAP. μF POS. 6 TO 8 | TOLERANCE CODE POS. 9 J = ± 5 % K = ± 10 % M = ± 20 % | DIMENSIONS MAX. w x h x l (mm) | MASS (g) ⁽³⁾ | SPQ ⁽⁴⁾ SHORT LEADS (PIECES) | ORDERING CODE ⁽²⁾ | | | | | | |
| | | | | | | TYPE | C-VALUE | TOL. | VOLTAGE | PITCH | LEAD LENGTH DESIGN | |
| | | | | | | 1 TO 5 | 6 TO 8 | 9 | 10 | 11 | 12 TO 14 ⁽¹⁾ | |
| PITCH 22.5 mm ± 0.4 mm; d_t = 0.80 mm ± 0.08 mm | | | | | | | | | | | | |
| 310 | 0.12 | K | 6.0 x 15.5 x 26.0 | 2.4 | 260 | F1778 | 412 | K | . | I | ..0 | |
| | 0.15 | K/M | 6.0 x 15.5 x 26.0 | 2.4 | 260 | F1778 | 415 | . | . | I | ..0 | |
| | 0.18 | K | 6.0 x 15.5 x 26.0 | 2.4 | 260 | F1778 | 418 | K | . | I | ..0 | |
| | 0.22 | K/M | 6.0 x 15.5 x 26.0 | 2.4 | 260 | F1778 | 422 | . | . | I | ..0 | |
| | 0.27 | K | 6.0 x 15.5 x 26.0 | 2.4 | 200 | F1778 | 427 | K | . | I | ..0 | |
| | 0.33 | K | 6.0 x 15.5 x 26.0 | 2.4 | 190 | F1778 | 433 | K | . | I | ..0 | |
| | 0.33 | M | 6.0 x 15.5 x 26.0 | 2.4 | 235 | F1778 | 433 | M | . | I | ..0 | |
| | 0.39 | K | 7.0 x 16.5 x 26.0 | 2.9 | 200 | F1778 | 439 | K | . | I | ..0 | |
| | 0.47 | K | 7.0 x 16.5 x 26.0 | 2.9 | 190 | F1778 | 447 | K | . | I | ..0 | |
| | 0.47 | M | 7.0 x 16.5 x 26.0 | 2.9 | 200 | F1778 | 447 | M | . | I | ..0 | |
| | 0.56 | K | 8.5 x 18.0 x 26.0 | 3.8 | 150 | F1778 | 456 | K | . | I | ..0 | |
| | 0.68 | K | 10.0 x 19.5 x 26.0 | 6.8 | 150 | F1778 | 468 | K | . | I | ..0 | |
| | 0.68 | M | 8.5 x 18.0 x 26.0 | 3.8 | 170 | F1778 | 468 | M | . | I | ..0 | |
| | 0.82 | K | 10.0 x 19.5 x 26.0 | 6.8 | 200 | F1778 | 482 | K | . | I | ..0 | |
| | 1.0 | K | 12.0 x 22.0 x 26.0 | 7.8 | 150 | F1778 | 510 | K | . | I | ..0 | |
| | 1.0 | M | 10.0 x 19.5 x 26.0 | 6.8 | 135 | F1778 | 510 | M | . | I | ..0 | |
| | 1.5 | M | 12.5 x 22.5 x 26.5 | 10 | 140 | F1778 | 515 | M | . | I | ..0 | |
| | PITCH 27.5 mm ± 0.4 mm; d_t = 0.80 mm ± 0.08 mm | | | | | | | | | | | |
| | | 0.47 | K/M | 9.0 x 19.0 x 31.5 | 5.5 | 160 | F1778 | 447 | . | . | K | ..0 |
| | | 0.56 | K | 9.0 x 19.0 x 31.5 | 5.5 | 160 | F1778 | 456 | K | . | K | ..0 |
| | 0.68 | K/M | 9.0 x 19.0 x 31.5 | 5.5 | 160 | F1778 | 468 | . | . | K | ..0 | |
| | 0.82 | K | 11.0 x 21.0 x 31.0 | 7.4 | 125 | F1778 | 482 | K | . | K | ..0 | |
| | 1.0 | K/M | 11.0 x 21.0 x 31.0 | 7.4 | 125 | F1778 | 510 | . | . | K | ..0 | |
| | 1.2 | K | 11.0 x 21.0 x 31.0 | 7.4 | 110 | F1778 | 512 | K | . | K | ..0 | |
| | 1.5 | K/M | 13.0 x 23.0 x 31.0 | 9.2 | 110 | F1778 | 515 | . | . | K | ..0 | |
| | 1.8 | K | 15.0 x 25.0 x 31.5 | 12.3 | 85 | F1778 | 518 | K | . | K | ..0 | |
| | 2.2 | K/M | 15.0 x 25.0 x 31.5 | 12.3 | 85 | F1778 | 522 | . | . | K | ..0 | |
| | 2.7 | K | 18.0 x 28.0 x 31.5 | 16.1 | 100 | F1778 | 527 | K | . | K | ..0 | |
| | 3.3 | K | 21.0 x 31.0 x 31.0 | 20.3 | 70 | F1778 | 533 | K | . | K | ..0 | |
| | 3.3 | M | 18.0 x 28.0 x 31.5 | 16.1 | 80 | F1778 | 533 | M | . | K | ..0 | |
| | 3.9 | K | 21.0 x 31.0 x 31.0 | 20.3 | 50 | F1778 | 539 | K | . | K | ..0 | |
| | 4.7 | M | 21.0 x 31.0 x 31.0 | 20.3 | 50 | F1778 | 547 | M | . | K | ..0 | |

Notes

- SPQ = Standard Packing Quantity
- For detailed tape specifications refer to packaging information: www.vishay.com/doc?28139
- (1) For further packaging see table "Composition of Catalog Number"
- (2) Further information about packaging quantities with different lead length and/or taped versions, see document "Packing Quantities" www.vishay.com/doc?27608
- (3) Weight for short lead product only



| APPROVALS | | | |
|--|---------------------|----------------|--|
| SAFETY APPROVALS X2 | VOLTAGE | VALUE | FILE NUMBERS |
| EN 60384-14 (ENEC) (= IEC 60384-14) | 310 V _{AC} | 1 nF to 4.7 μF | FI 2013003 |
| UL 60384-14 | 310 V _{AC} | 1 nF to 4.7 μF | E354331 |
| CSA-E384-14 | 310 V _{AC} | 1 nF to 4.7 μF | 2123580 |
| CQC | 310 V _{AC} | 1 nF to 4.7 μF | CQC08001026060 (F) CQC08001026061 (L) |
| CB test certificate | 310 V _{AC} | 1 nF to 4.7 μF | FI 5123 A1 |
| The ENEC-approval together with the CB-certificate replace all national marks of the following countries (they have already signed the ENEC-agreement): Austria; Belgium; Czech Republic; Denmark; Finland; France; Germany; Greece; Hungary; Ireland; Italy; Luxembourg; Netherlands; Norway; Portugal; Slovenian; Spain; Sweden; Switzerland and United Kingdom. | | | |
|    | | | |

MOUNTING

Normal Use

The capacitors are designed for mounting on printed-circuit boards. The capacitors packed in bandoliers are designed for mounting in printed circuit boards by means of automatic insertion machines.

For detailed tape specifications refer to Packaging Information: www.vishay.com/doc?28139

Specific Method of Mounting to Withstand Vibration and Shock

In order to withstand vibration and shock tests, it must be ensured that the stand-off pips are in good contact with the printed-circuit board:

- For pitches ≤ 15 mm capacitors shall be mechanically fixed by the leads
- For larger pitches the capacitors shall be mounted in the same way and the body clamped in addition

Space Requirements on Printed Circuit-Board

The maximum space for length ($l_{max.}$), width ($w_{max.}$), and height ($h_{max.}$) of film capacitors to take in account on the printed circuit board is shown in the drawings:

- For products with pitch ≤ 15 mm, $\Delta w \times \Delta l = 0.3$ mm and $\Delta h = 0.1$ mm
- For products with 15 mm $<$ pitch ≤ 27.5 mm, $\Delta w \times \Delta l = 0.5$ mm and $\Delta h = 0.1$ mm
- For products with pitch = 37.5 mm, $\Delta w \times \Delta l = 0.7$ mm and $\Delta h = 0.5$ mm

Eccentricity defined as in drawing. The maximum eccentricity is smaller than or equal to the lead diameter of the product concerned.

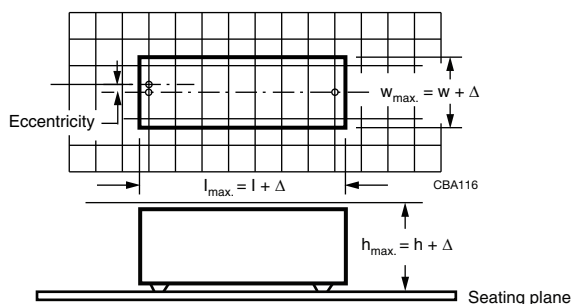



SOLDERING CONDITIONS

For general soldering conditions and wave soldering profile, we refer to the application note: "Soldering Guideline for Film Capacitors": www.vishay.com/doc?28171

Storage Temperature

- $T_{stg} = -25\text{ }^{\circ}\text{C}$ to $+35\text{ }^{\circ}\text{C}$ with RH maximum 75 % without condensation

Ratings and Characteristics Reference Conditions

Unless otherwise specified, all electrical values apply to an ambient free air temperature of $23\text{ }^{\circ}\text{C} \pm 1\text{ }^{\circ}\text{C}$, an atmospheric pressure of 86 kPa to 106 kPa and a relative humidity of $50\text{ } \% \pm 2\text{ } \%$.

For reference testing, a conditioning period shall be applied over $96\text{ h} \pm 4\text{ h}$ by heating the products in a circulating air oven at the rated temperature and a relative humidity not exceeding 20 %.

CHARACTERISTICS

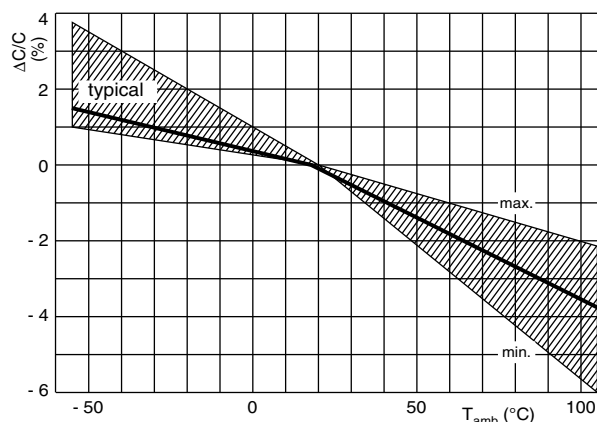

Capacitance as a function of ambient temperature (typical curve)

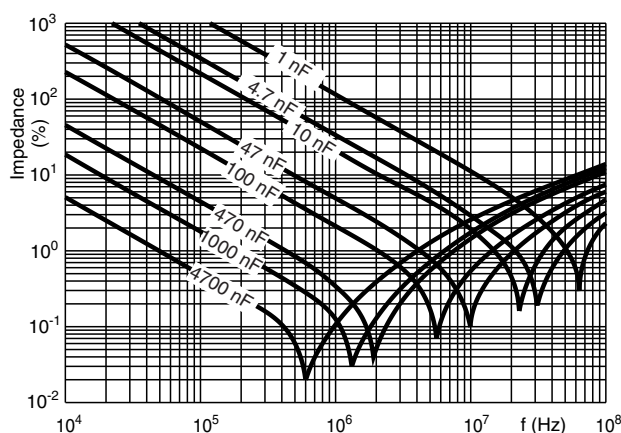

Impedance as a function of frequency (typical curve)

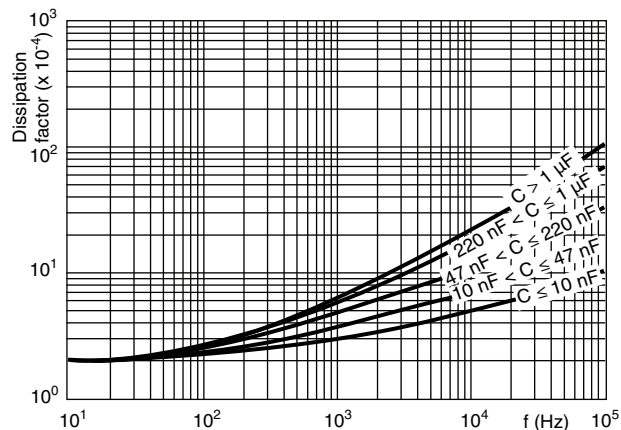

Tangent of loss angle as a function of frequency (typical curve)

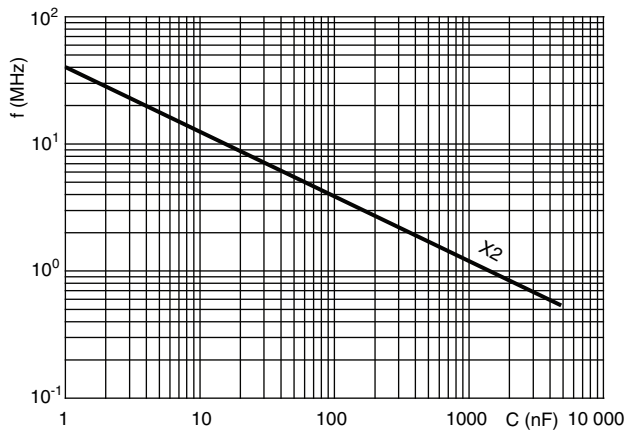

Resonant frequency as a function of capacitance (typical curve)

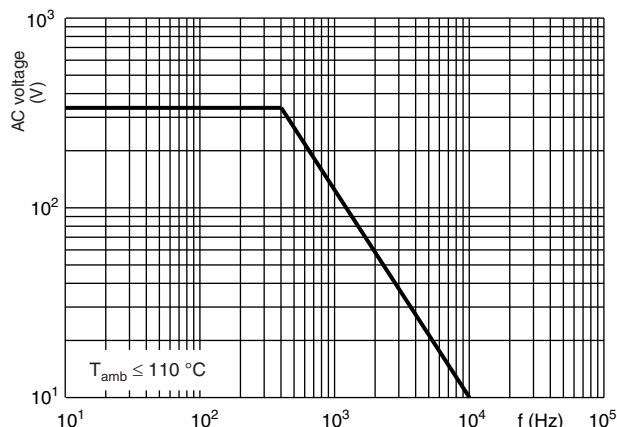

Max. RMS voltage as a function of frequency (typical curve)

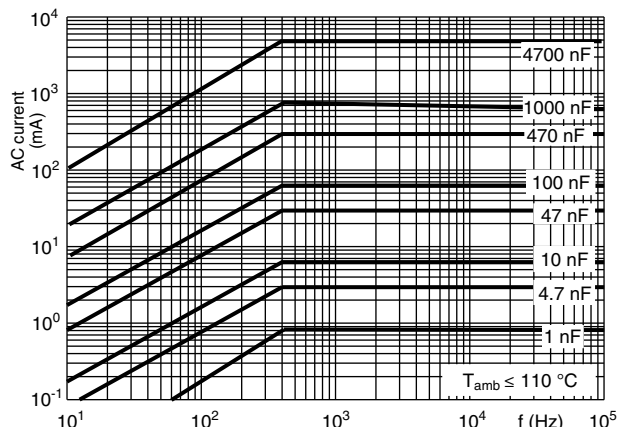

Max. RMS current as a function of frequency (typical curve)

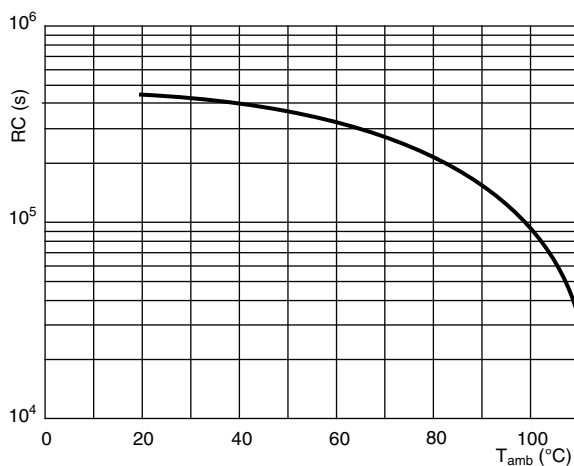

Insulation resistance as a function of ambient temperature (typical curve)

APPLICATION NOTES

- For X2 electromagnetic interference suppression in **standard across the line applications** (50 Hz/60 Hz) with a maximum mains voltage of 310 V_{AC}.
- For series impedance applications we refer to application note www.vishay.com/doc?28153
- For capacitors connected in parallel, normally the proof voltage and possibly the rated voltage must be reduced. For information depending of the capacitance value and the number of parallel connections contact: rfi@vishay.com
- These capacitors are not intended for continuous pulse applications. For these situations, capacitors of the AC and pulse programs must be used.
- The maximum ambient temperature must not exceed 110 °C (125 °C for less than 1000 h) for C ≤ 470 nF and 110 °C for C > 470 nF.
- Rated voltage pulse slope:
If the pulse voltage is lower than the rated voltage, the values of the specific reference data can be multiplied by 435 V_{DC} and divided by the applied voltage.



INSPECTION REQUIREMENTS

General Notes

Sub-clause numbers of tests and performance requirements refer to the “Sectional Specification, IEC Publication IEC 60384-14 ed-3 and Specific Reference Data”.

| GROUP C INSPECTION REQUIREMENTS | | |
|---|--|---|
| SUB-CLAUSE NUMBER AND TEST | CONDITIONS | PERFORMANCE REQUIREMENTS |
| SUB-GROUP C1A PART OF SAMPLE OF SUB-GROUP C1 | | |
| 4.1 Dimensions (detail) | | As specified in section “General Data” of this specification |
| Initial measurements | Capacitance Tangent of loss angle: For C ≤ 1 µF at 10 kHz For C > 1 µF at 1 kHz | |
| 4.3 Robustness of terminations | Tensile: Load 10 N; 10 s Bending: Load 5 N; 4 x 90° | No visible damage |
| 4.4 Resistance to soldering heat | No pre-drying Method: 1A Solder bath: 280 °C ± 5 °C Duration: 10 s | |
| 4.19 Component solvent resistance | Isopropylalcohol at room temperature Method: 2 Immersion time: 5 min ± 0.5 min Recovery time: Min. 1 h, max. 2 h | |
| 4.4.2 Final measurements | Visual examination | No visible damage Legible marking |
| | Capacitance | ΔC/C ≤ 5 % of the value measured initially. |
| | Tangent of loss angle | Increase of tan δ: ≤ 0.008 for: C ≤ 1 µF or ≤ 0.005 for: C > 1 µF Compared to values measured initially. |
| | Insulation resistance | As specified in section “Insulation Resistance” of this specification |
| SUB-GROUP C1B PART OF SAMPLE OF SUB-GROUP C1 | | |
| Initial measurements | Capacitance Tangent of loss angle: For C ≤ 1 µF at 10 kHz For C > 1 µF at 1 kHz | |
| 4.20 Solvent resistance of the marking | Isopropylalcohol at room temperature Method: 1 Rubbing material: cotton wool Immersion time: 5 min ± 0.5 min | No visible damage Legible marking |
| 4.6 Rapid change of temperature | θA = - 55 °C θB = + 110 °C 5 cycles Duration t = 30 min | |
| 4.6.1 Inspection | Visual examination | No visible damage |
| 4.7 Vibration | Mounting: See section “Mounting” of this specification Procedure B4 Frequency range: 10 Hz to 55 Hz Amplitude: 0.75 mm or Acceleration 98 m/s ² (whichever is less severe) Total duration 6 h | |



| GROUP C INSPECTION REQUIREMENTS | | |
|--|---|---|
| SUB-CLAUSE NUMBER AND TEST | CONDITIONS | PERFORMANCE REQUIREMENTS |
| SUB-GROUP C1B PART OF SAMPLE OF SUB-GROUP C1 | | |
| 4.7.2 Final inspection | Visual examination | No visible damage |
| 4.9 Shock | Mounting: See section "Mounting" for more information Pulse shape: Half sine Acceleration: 490 m/s ² Duration of pulse: 11 ms | |
| 4.9.2 Final measurements | Visual examination Capacitance Tangent of loss angle Insulation resistance | No visible damage $ \Delta C/C \leq 5\%$ of the value measured initially. Increase of $\tan \delta$: ≤ 0.008 for: $C \leq 1 \mu\text{F}$ or ≤ 0.005 for: $C > 1 \mu\text{F}$ Compared to values measured initially. As specified in section "Insulation Resistance" of this specification |
| SUB-GROUP C1 COMBINED SAMPLE OF SPECIMENS OF SUB-GROUPS C1A AND C1B | | |
| 4.11 Climatic sequence | | |
| 4.11.1 Initial measurements | Capacitance Measured in 4.4.2 and 4.9.2 Tangent of loss angle: Measured initially in C1A and C1B | |
| 4.11.2 Dry heat | Temperature: 110 °C | |
| 4.11.3 Damp heat cyclic Test Db First cycle | Duration: 16 h | |
| 4.11.4 Cold | Temperature: - 55 °C | |
| 4.11.5 Damp heat cyclic Test Db Remaining cycles | Duration: 2 h | |
| 4.11.6 Final measurements | Visual examination Capacitance Tangent of loss angle Voltage proof 1350 V _{DC} ; 1 min between terminations Insulation resistance | No visible damage Legible marking $ \Delta C/C \leq 5\%$ of the value measured in 4.11.1. Increase of $\tan \delta$: ≤ 0.008 for: $C \leq 1 \mu\text{F}$ or ≤ 0.005 for: $C > 1 \mu\text{F}$ Compared to values measured in 4.11.1. No permanent breakdown or flash-over $\geq 50\%$ of values specified in section "Insulation Resistance" of this specification |
| SUB GROUP C2 | | |
| 4.12 Damp heat steady state | 56 days; 40 °C; 90 % to 95 % RH no load | |
| 4.12.1 Initial measurements | Capacitance Tangent of loss angle: at 1 kHz | |
| 4.12.3 Final measurements | Visual examination Capacitance | No visible damage Legible marking $ \Delta C/C \leq 5\%$ of the value measured in 4.12.1. |



| GROUP C INSPECTION REQUIREMENTS | | |
|---------------------------------|---|---|
| SUB-CLAUSE NUMBER AND TEST | CONDITIONS | PERFORMANCE REQUIREMENTS |
| SUB GROUP C2 | | |
| 4.12.3 Final measurements | Tangent of loss angle Voltage proof 1350 V _{DC} ; 1 min between terminations Insulation resistance | Increase of tan δ: ≤ 0.008 for: C ≤ 1 μF or ≤ 0.005 for: C > 1 μF Compared to values measured in 4.12.1. No permanent breakdown or flash-over ≥ 50 % of values specified in section "Insulation Resistance" of this specification |
| SUB-GROUP C3 | | |
| 4.13.1 Initial measurements | Capacitance Tangent of loss angle: For C ≤ 1 μF at 10 kHz For C > 1 μF at 1 kHz | |
| 4.13 Impulse voltage | 3 successive impulses, full wave, peak voltage: X2: 2.5 kV for C ≤ 1 μF X2: 2.5 kV/√C for C > 1 μF Max. 24 pulses | No self healing, breakdowns or flash-over |
| 4.14 Endurance | Duration: 1000 h 1.25 x U _{RAC} at 110 °C Once in every hour the voltage is increased to 1000 V _{RMS} for 0.1 s via resistor of 47 Ω ± 5 % | |
| 4.14.7 Final measurements | Visual examination Capacitance Tangent of loss angle Voltage proof 1350 V _{DC} ; 1 min between terminations 2120 V _{AC} ; 1 min between terminations and case Insulation resistance | No visible damage Legible marking ΔC/C ≤ 10 % compared to values measured in 4.13.1. Increase of tan δ: ≤ 0.008 for: C ≤ 1 μF or ≤ 0.005 for: C > 1 μF Compared to values measured in 4.13.1. No permanent breakdown or flash-over ≥ 50 % of values specified in section "Insulation Resistance" of this specification |
| SUB-GROUP C4 | | |
| 4.15 Charge and discharge | 10 000 cycles Charged to 435 V _{DC} Discharge resistance: $R = \frac{435 V_{DC}}{1.25 \times C (dU/dt)}$ | |
| 4.15.1 Initial measurements | Capacitance Tangent of loss angle: For C ≤ 1 μF at 10 kHz For C > 1 μF at 1 kHz | |
| 4.15.3 Final measurements | Capacitance Tangent of loss angle Insulation resistance | ΔC/C ≤ 10 % compared to values measured in 4.15.1. Increase of tan δ: ≤ 0.008 for: C ≤ 1 μF or ≤ 0.005 for: C > 1 μF Compared to values measured in 4.15.1. ≥ 50 % of values specified in section "Insulation Resistance" of this specification |

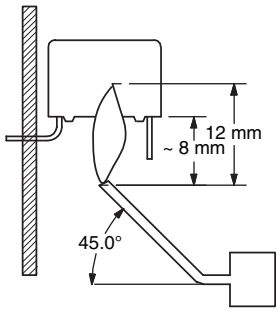

| GROUP C INSPECTION REQUIREMENTS | | |
|--------------------------------------|---|--|
| SUB-CLAUSE NUMBER AND TEST | CONDITIONS | PERFORMANCE REQUIREMENTS |
| SUB-GROUP C5 | | |
| 4.16 Radio frequency characteristic | Resonance frequency | ≥ 0.9 times the value as specified in section "Resonant Frequency" of this specification. |
| SUB-GROUP C6 | | |
| 4.17 Passive flammability Class B | Bore of gas jet: Ø 0.5 mm Fuel: Butane Test duration for actual volume V in mm ³ : V ≤ 250: 10 s 250 < V ≤ 500: 20 s 500 < V ≤ 1750: 30 s V > 1750: 60 s One flame application  | After removing test flame from capacitor, the capacitor must not continue to burn for more than 10 s. No burning particle must drop from the sample. |
| SUB-GROUP C7 | | |
| 4.18 Active flammability | 20 cycles of 2.5 kV discharges on the test capacitor connected to U _{RAC} . | The cheese cloth around the capacitors shall not burn with a flame. No electrical measurements are required. |



Disclaimer

ALL PRODUCT, PRODUCT SPECIFICATIONS AND DATA ARE SUBJECT TO CHANGE WITHOUT NOTICE TO IMPROVE RELIABILITY, FUNCTION OR DESIGN OR OTHERWISE.

Vishay Intertechnology, Inc., its affiliates, agents, and employees, and all persons acting on its or their behalf (collectively, "Vishay"), disclaim any and all liability for any errors, inaccuracies or incompleteness contained in any datasheet or in any other disclosure relating to any product.

Vishay makes no warranty, representation or guarantee regarding the suitability of the products for any particular purpose or the continuing production of any product. To the maximum extent permitted by applicable law, Vishay disclaims (i) any and all liability arising out of the application or use of any product, (ii) any and all liability, including without limitation special, consequential or incidental damages, and (iii) any and all implied warranties, including warranties of fitness for particular purpose, non-infringement and merchantability.

Statements regarding the suitability of products for certain types of applications are based on Vishay's knowledge of typical requirements that are often placed on Vishay products in generic applications. Such statements are not binding statements about the suitability of products for a particular application. It is the customer's responsibility to validate that a particular product with the properties described in the product specification is suitable for use in a particular application. Parameters provided in datasheets and/or specifications may vary in different applications and performance may vary over time. All operating parameters, including typical parameters, must be validated for each customer application by the customer's technical experts. Product specifications do not expand or otherwise modify Vishay's terms and conditions of purchase, including but not limited to the warranty expressed therein.

Except as expressly indicated in writing, Vishay products are not designed for use in medical, life-saving, or life-sustaining applications or for any other application in which the failure of the Vishay product could result in personal injury or death. Customers using or selling Vishay products not expressly indicated for use in such applications do so at their own risk. Please contact authorized Vishay personnel to obtain written terms and conditions regarding products designed for such applications.

No license, express or implied, by estoppel or otherwise, to any intellectual property rights is granted by this document or by any conduct of Vishay. Product names and markings noted herein may be trademarks of their respective owners.

Material Category Policy

Vishay Intertechnology, Inc. hereby certifies that all its products that are identified as RoHS-Compliant fulfill the definitions and restrictions defined under Directive 2011/65/EU of The European Parliament and of the Council of June 8, 2011 on the restriction of the use of certain hazardous substances in electrical and electronic equipment (EEE) - recast, unless otherwise specified as non-compliant.

Please note that some Vishay documentation may still make reference to RoHS Directive 2002/95/EC. We confirm that all the products identified as being compliant to Directive 2002/95/EC conform to Directive 2011/65/EU.

Vishay Intertechnology, Inc. hereby certifies that all its products that are identified as Halogen-Free follow Halogen-Free requirements as per JEDEC JS709A standards. Please note that some Vishay documentation may still make reference to the IEC 61249-2-21 definition. We confirm that all the products identified as being compliant to IEC 61249-2-21 conform to JEDEC JS709A standards.