

# MA9264

## RADIATION HARD 8192 x 8 BIT STATIC RAM

The MA9264 64k Static RAM is configured as 8192x8 bits and manufactured using CMOS-SOS high performance, radiation hard, 1.5µm technology.

The design uses a 6 transistor cell and has full static operation with no clock or timing strobe required. Address input buffers are deselected when chip select is in the HIGH state.

See Application Note "Overview of the GPS Radiation Hard 1.5µm CMOS/SOS SRAM Range".

### FEATURES

- 1.5µm CMOS-SOS Technology
- Latch-up Free
- Fast Access Time 55ns Typical
- Total Dose 10<sup>6</sup> Rad(Si)
- Transient Upset >10<sup>11</sup> Rad(Si)/sec
- SEU 4.3 x 10<sup>-11</sup> Errors/bitday
- Single 5V Supply
- Three State Output
- Low Standby Current 100µA Typical
- -55°C to +125°C Operation
- All Inputs and Outputs Fully TTL or CMOS Compatible
- Fully Static Operation

Operation Mode	$\overline{CS}$	CE	$\overline{OE}$	$\overline{WE}$	I/O	Power
Read	L	H	L	H	D OUT	ISB1
Write	L	H	X	L	D IN	
Output Disable	L	H	H	H	High Z	
Standby	H	X	X	X	High Z	ISB2
	X	L	X	X	X	

Figure 1: Truth Table

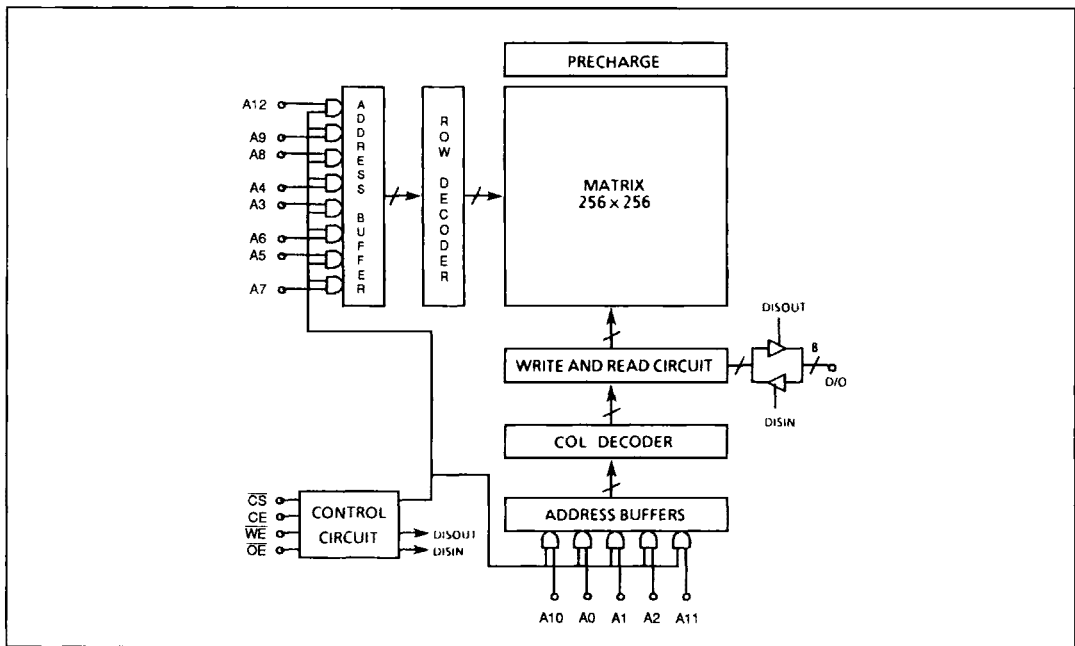

Figure 2: Block Diagram

## MA9264

### SIGNAL DEFINITIONS

#### A0-12

Address input pins which select a particular eight bit word within the memory array.

#### D0-7

Bidirectional data pins which serve as data outputs during a read operation and as data inputs during a write operation.

#### $\overline{\text{CS}}$

Chip Select, which, at low level, activates a read or write operation. When at a high level it defaults the SRAM to a precharge condition and holds the data output drivers in a high impedance state.

#### $\overline{\text{WE}}$

Write Enable which when at a low level enables a write and holds data output drivers in a high impedance state. When at a high level, it enables a read.

#### $\overline{\text{OE}}$

Output Enable which when at a high level holds the data output drivers in a high impedance state. When at a low level, data output driver state is defined by  $\overline{\text{CS}}$ ,  $\overline{\text{WE}}$  and CE. If this signal is not used it must be connected to VSS.

#### CE

Chip Enable which when at a high level allows normal operation. When at a low level it defaults the SRAM to a precharge condition, disables the input circuits on all input pins and holds the data output drivers in a high impedance state. If this signal is not used it must be connected to VDD.

## CHARACTERISTICS AND RATINGS

Symbol	Parameter	Min.	Max.	Units
$V_{CC}$	Supply Voltage	-0.5	7.0	V
$V_I$	Input Voltage	-0.3	$V_{DD}+0.3$	V
$T_A$	Operating Temperature	-55	125	°C
$T_S$	Storage Temperature	-65	150	°C

Stresses above those listed may cause permanent damage to the device. This is a stress rating only and functional operation of the device at these conditions, or at any other condition above those indicated in the operations section of this specification, is not implied. Exposure to absolute maximum rating conditions for extended periods may affect device reliability.

Figure 3: Absolute Maximum Ratings

Notes for Tables 4 and 5:

Characteristics apply to pre radiation at  $T_A = -55^{\circ}\text{C}$  to  $+125^{\circ}\text{C}$  with  $V_{DD} = 5\text{V} \pm 10\%$  and to post 100k Rad(Si) total dose radiation at  $T_A = 25^{\circ}\text{C}$  with  $V_{DD} = 5\text{V} \pm 10\%$  (characteristics at higher radiation levels available on request). GROUP A SUBGROUPS 1, 2, 3.

Symbol	Parameter	Conditions	(Option)	Min.	Typ.	Max.	Units
$V_{DD}$	Supply voltage	-		4.5	5.0	5.5	V
$V_{IH}$	Logical '1' Input Voltage	-	(TTL)	2.0	-	$V_{DD}$	V
			(CMOS)	$0.8 V_{DD}$	-	$V_{DD}$	V
$V_{IL}$	Logical '0' Input Voltage	-	(TTL)	$V_{SS}$	-	0.8	V
			(CMOS)	$V_{SS}$	-	$0.2 V_{DD}$	V
$V_{OH1}$	Logical '1' Output Voltage	$I_{OH1} = -2\text{mA}$		2.4	-	-	V
$V_{OH2}$	Logical '1' Output Voltage	$I_{OH2} = -1\text{mA}$		$V_{DD} - 0.5$	-	-	V
$V_{OL}$	Logical '0' Output Voltage	$I_{OL} = 4\text{mA}$		-	-	0.4	V
$I_{LI}$	Input Leakage Current	$V_{IN} = V_{DD}$ or $V_{SS}$ All inputs		-	-	$\pm 10$	$\mu\text{A}$
$I_{LO}$	Output Leakage Current	Chip disabled, $V_{OUT} = V_{DD}$ or $V_{SS}$		-	-	$\pm 10$	$\mu\text{A}$
$I_{SB1}$	Selected Static Current (CMOS)	All inputs = $V_{DD} - 0.2\text{V}$ except $\overline{\text{CS}} = V_{SS} + 0.2\text{V}$		-	0.1	10	mA
$I_{DD}$	Dynamic Operating Current (CMOS)	$f_{RC} = 1\text{MHz}$ , all inputs switching, $V_{IH} = V_{DD} - 0.2\text{V}$		-	6	18	mA
$I_{SB2}$	Standby Supply Current	$\overline{\text{CS}} = V_{DD} - 0.2\text{V}$ $\text{CE} = V_{SS} + 0.2\text{V}$		-	0.1	10	mA

Figure 4: Electrical Characteristics

Symbol	Parameter	Conditions	(Option)	Min.	Typ.	Max.	Units
$V_{DR}$	$V_{CC}$ for Data Retention	$\overline{\text{CS}} = V_{DR}$ , $\text{CE} = V_{SS}$		2.0	-	-	V
$I_{DDR}$	Data Retention Current	$\overline{\text{CS}} = V_{DR}$ , $V_{DR} = 2.0\text{V}$ $\text{CE} = V_{SS}$		-	0.05	4	mA

Figure 5: Data Retention Characteristics

## MA9264

### AC CHARACTERISTICS

Conditions of Test for Tables 5 and 6:

1. Input pulse =  $V_{SS}$  to 3.0V (TTL) and  $V_{SS}$  to 4.0V (CMOS).
2. Times measurement reference level = 1.5V.
3. Input Rise and Fall times  $\leq 5$ ns.
4. Output load 1TTL gate and  $CL = 60$ pF.
5. Transition is measured at  $\pm 500$ mV from steady state.
6. This parameter is sampled and not 100% tested.

Notes for Tables 6 and 7:

Characteristics apply to pre-radiation at  $T_A = -55^\circ\text{C}$  to  $+125^\circ\text{C}$  with  $V_{DD} = 5V \pm 10\%$  and to post 100k Rad(Si) total dose radiation at  $T_A = 25^\circ\text{C}$  with  $V_{DD} = 5V \pm 10\%$ . GROUP A SUBGROUPS 9, 10, 11.

Symbol	Parameter	MAX9264X70		MAX9264X95		Units
		Min	Max	Min	Max	
$T_{AVAVR}$	Read Cycle Time	70	-	95	-	ns
$T_{AVGV}$	Address Access Time	-	65	-	90	ns
$T_{EHOV}$	Chip Select Access Time	-	70	-	95	ns
$T_{SLOV}$	Chip Enable Access Time	-	70	-	95	ns
$T_{EHOX}$ (5,6)	Chip Selection to Output in Low Z	15	-	15	-	ns
$T_{SLOX}$ (5,6)	Chip Enable to Output in Low Z	15	-	15	-	ns
$T_{ELOZ}$ (5,6)	Chip Deselection to Output in High Z	0	20	0	20	ns
$T_{SHOZ}$ (5,6)	Chip Disable to Output in High Z	0	20	0	20	ns
$T_{AXOX}$	Output Hold from Address Change	30	-	40	-	ns
$T_{GLOV}$	Output Enable Access Time	-	25	-	30	ns
$T_{GLOX}$ (5,6)	Output Enable to Output in Low Z	15	-	15	-	ns
$T_{GHOZ}$ (5,6)	Output Enable to Output in High Z	0	20	0	20	ns

Figure 6: Read Cycle AC Electrical Characteristics

Symbol	Parameter	MAX9264X70		MAX9264X95		Units
		Min	Max	Min	Max	
$T_{AVAVW}$	Write~Cycle Time	45	-	60	-	ns
$T_{EHWH}$	Chip Selection to End of Write	45	-	60	-	ns
$T_{SLWH}$	Chip Enable to End of Write	45	-	60	-	ns
$T_{AVWH}$	Address Valid to End of Write	45	-	55	-	ns
$T_{AVWL}$	Address Set Up Time	0	-	0	-	ns
$T_{WLWH}$	Write Pulse Width	35	-	45	-	ns
$T_{WHAV}$	Write Recovery Time	0	-	0	-	ns
$T_{WLOZ}$ (5,6)	Write to Output in High Z	0	20	0	20	ns
$T_{OVWH}$	Data to Write Time Overlap	25	-	30	-	ns
$T_{WHDX}$	Data Hold from Write	0	-	0	-	ns
$T_{WHOX}$ (5,6)	Output Active from End to Write	0	20	0	20	ns

Figure 7: Write Cycle AC Electrical Characteristics

Symbol	Parameter	Conditions	Min.	Typ.	Max.	Units
$C_{IN}$	Input Capacitance	$V_I = 0V$	-	3	5	pF
$C_{OUT}$	Output Capacitance	$V_{IO} = 0V$	-	5	7	pF

Note:  $T_A = 25^\circ C$  and  $f = 1MHz$ . Data obtained by characterisation or analysis; not routinely measured.

Figure 8: Capacitance

Symbol	Parameter	Conditions
$F_T$	Basic Functionality	$V_{DD} = 4.5V - 5.5V$ , FREQ = 1MHz $V_{IL} = V_{SS}$ , $V_{IH} = V_{DD}$ , $V_{OL} \leq 1.5V$ , $V_{OH} \geq 1.5V$ TEMP = $-55^\circ C$ to $+125^\circ C$ , GPS PATTERN SET GROUP A SUBGROUPS 7, 8A, 8B

Figure 9: Functionality

Subgroup	Definition
1	Static characteristics specified in Tables 4 and 5 at $+25^\circ C$
2	Static characteristics specified in Tables 4 and 5 at $+125^\circ C$
3	Static characteristics specified in Tables 4 and 5 at $-55^\circ C$
7	Functional characteristics specified in Table 9 at $+25^\circ C$
8A	Functional characteristics specified in Table 9 at $+125^\circ C$
8B	Functional characteristics specified in Table 9 at $-55^\circ C$
9	Switching characteristics specified in Tables 6 and 7 at $+25^\circ C$
10	Switching characteristics specified in Tables 6 and 7 at $+125^\circ C$
11	Switching characteristics specified in Tables 6 and 7 at $-55^\circ C$

Figure 10: Definition of Subgroups

TIMING DIAGRAMS

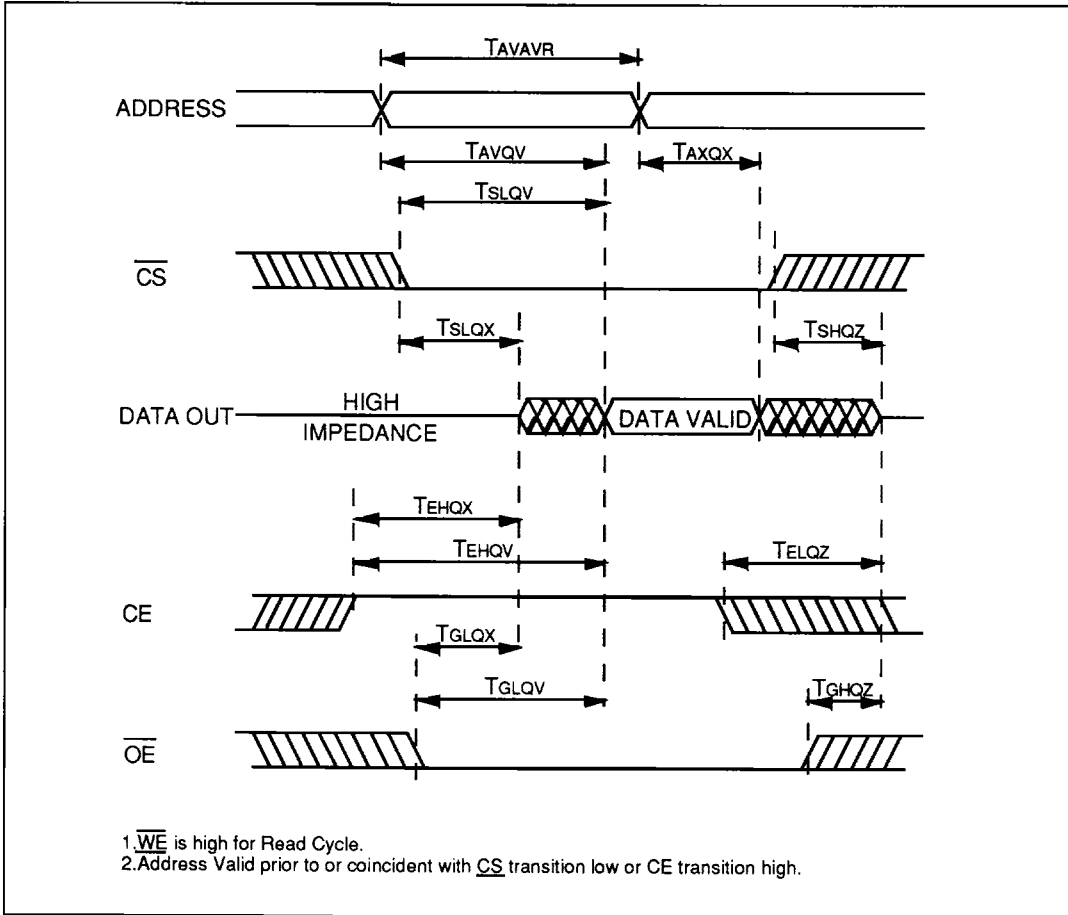

Figure 11a: Read Cycle 1

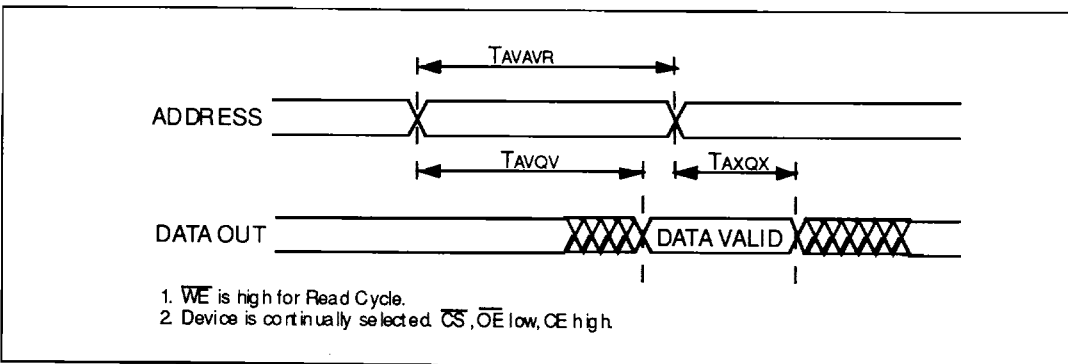
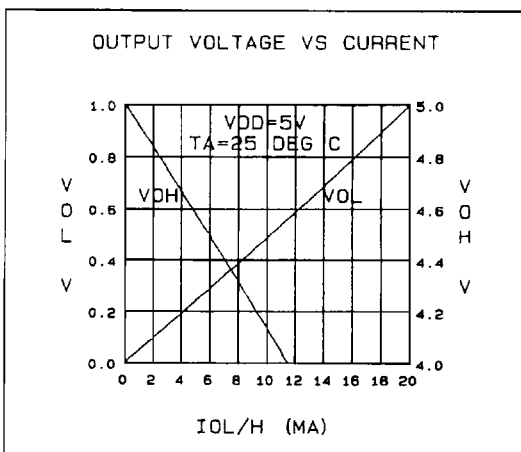
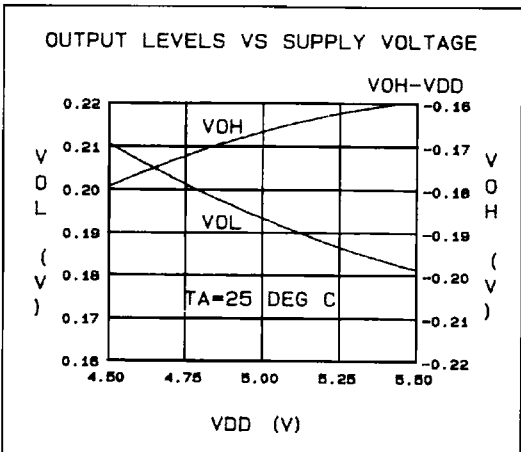
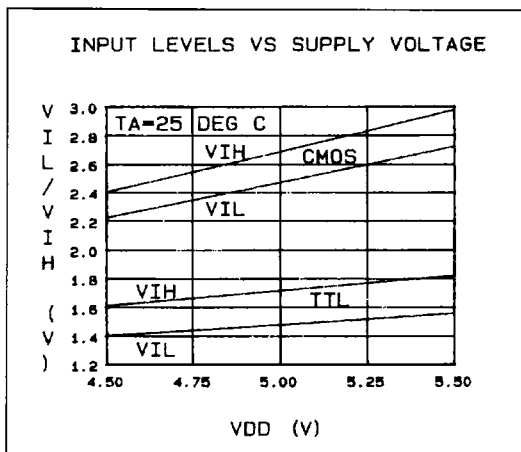
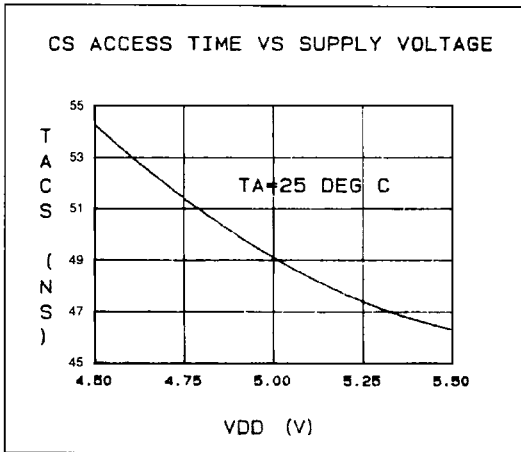
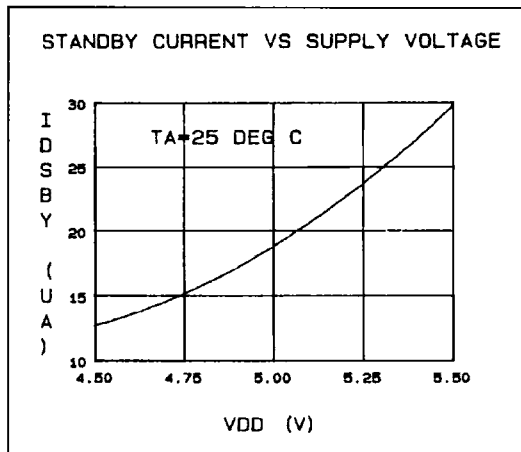
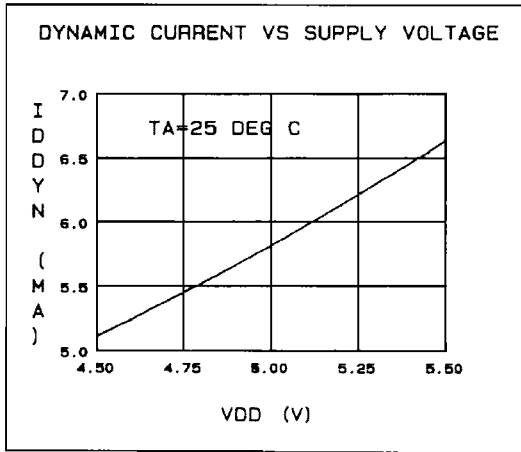

Figure 11b: Read Cycle 2



TYPICAL PERFORMANCE CHARACTERISTICS MAx9264x70





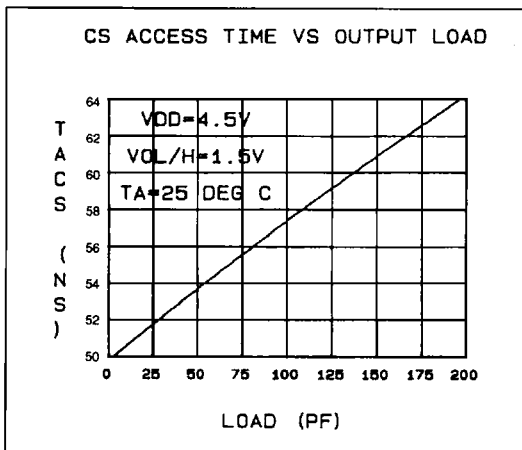
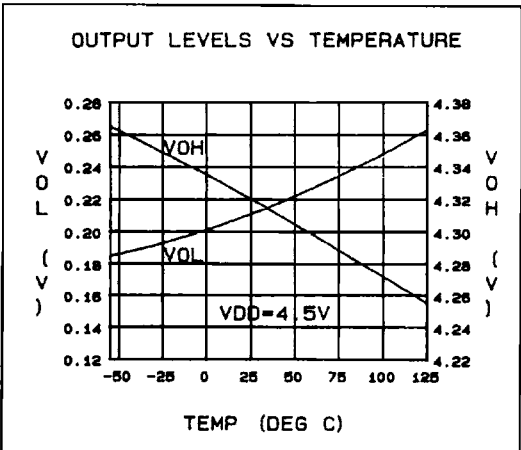
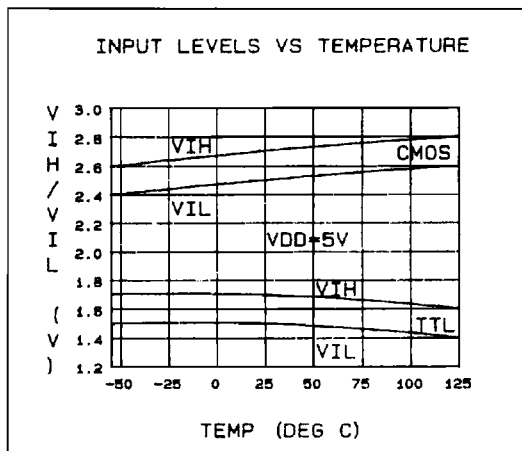
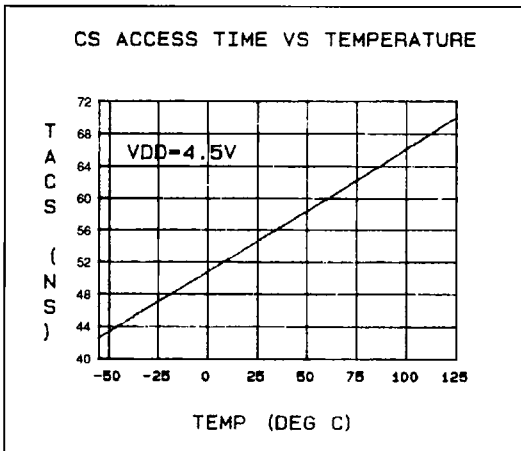
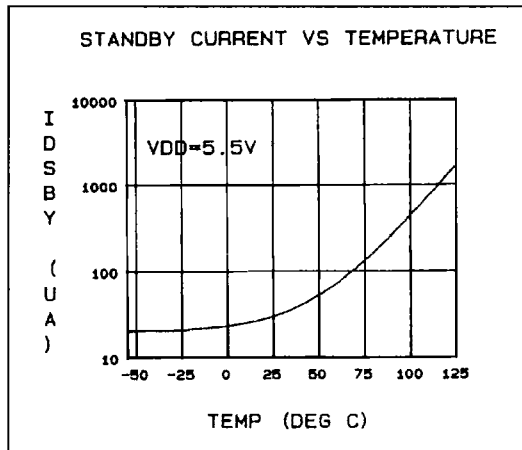
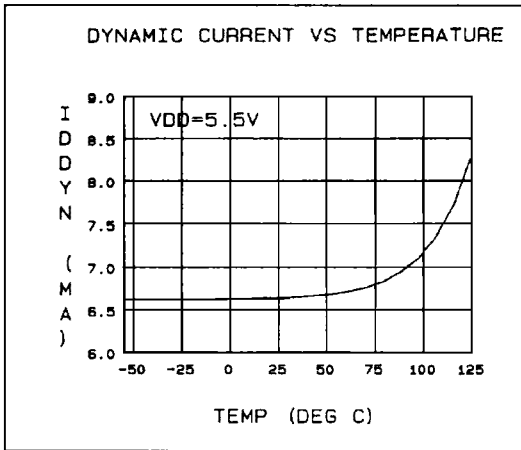

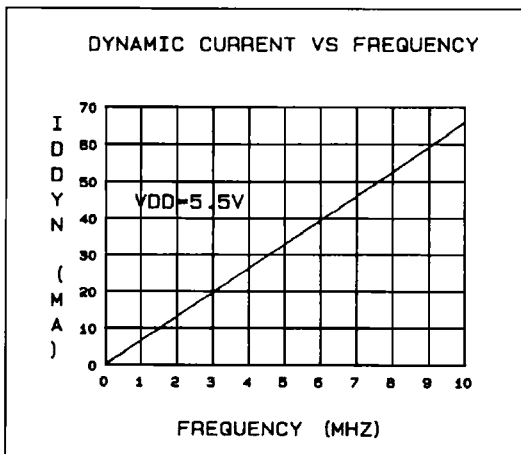
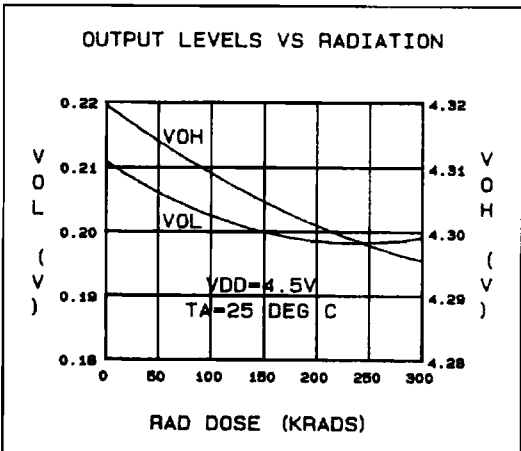
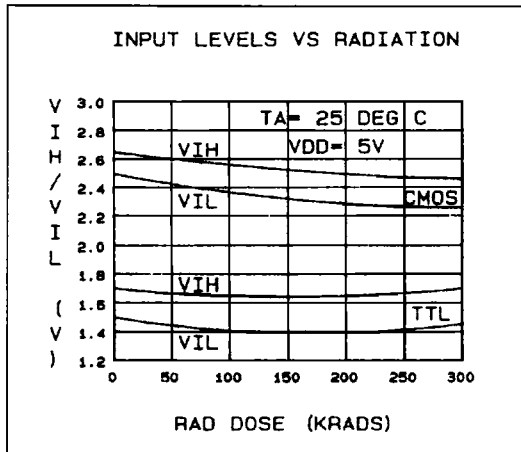
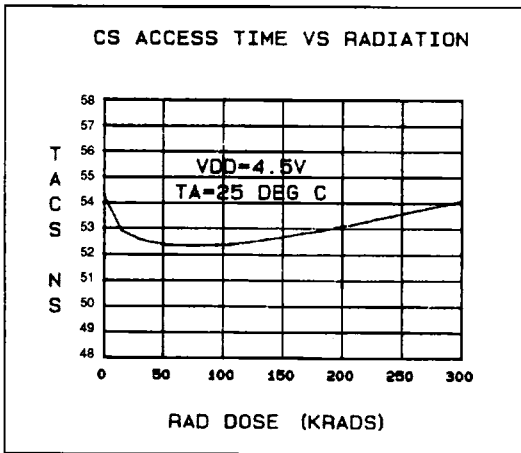
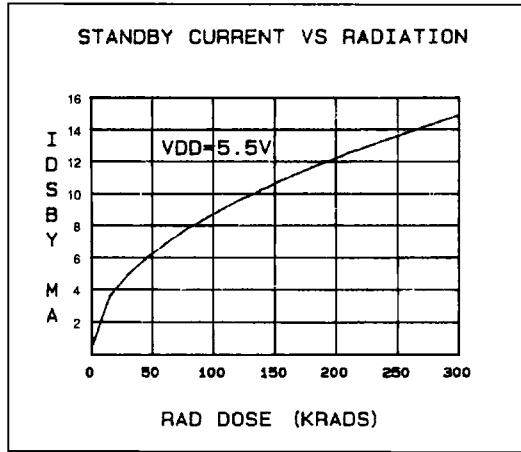
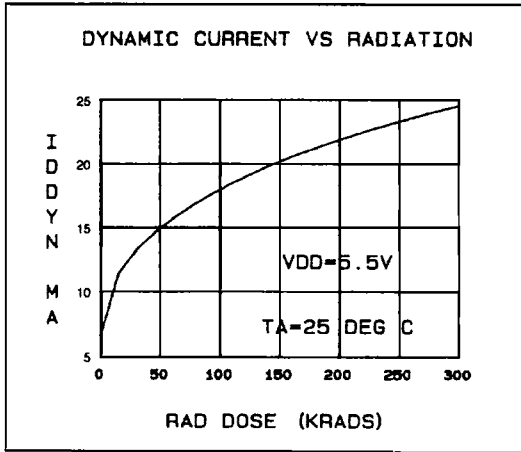

OUTLINES AND PIN ASSIGNMENTS

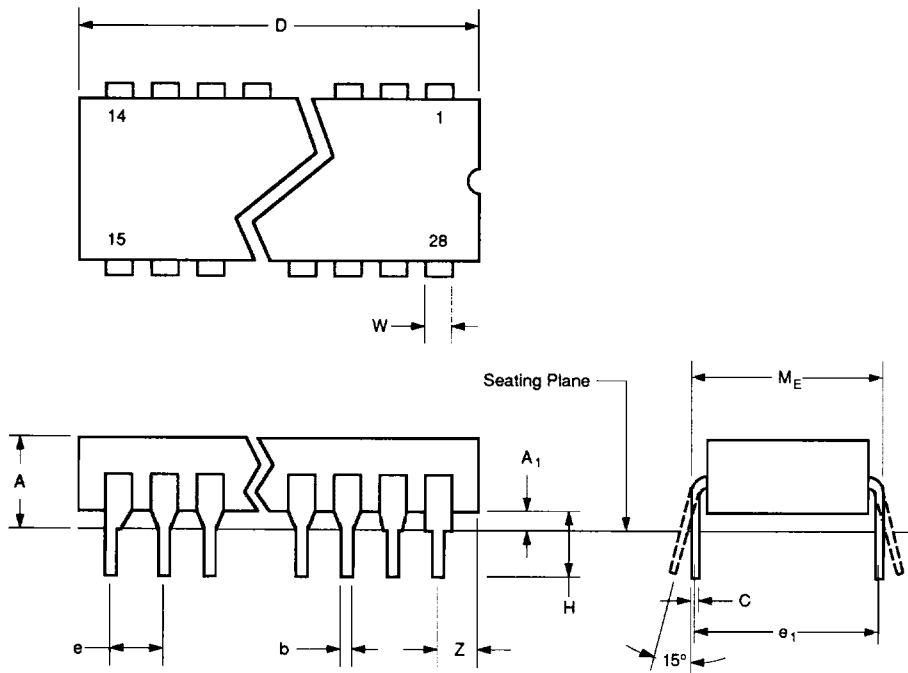

Ref	Millimetres			Inches		
	Min.	Nom.	Max.	Min.	Nom.	Max.
A	-	-	5.715	-	-	0.225
A1	0.38	-	1.53	0.015	-	0.060
b	0.35	-	0.59	0.014	-	0.023
c	0.20	-	0.36	0.008	-	0.014
D	-	-	36.02	-	-	1.418
e	-	2.54 Typ.	-	-	0.100 Typ.	-
e1	-	15.24 Typ.	-	-	0.600 Typ.	-
H	4.71	-	5.38	0.185	-	0.212
Me	-	-	15.90	-	-	0.626
Z	-	-	1.27	-	-	0.050
W	-	-	1.53	-	-	0.060

XG404

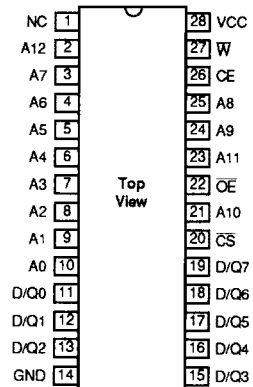

Figure 13: 28-Lead Ceramic DIL (Solder Seal) - Package Style C

MA9264

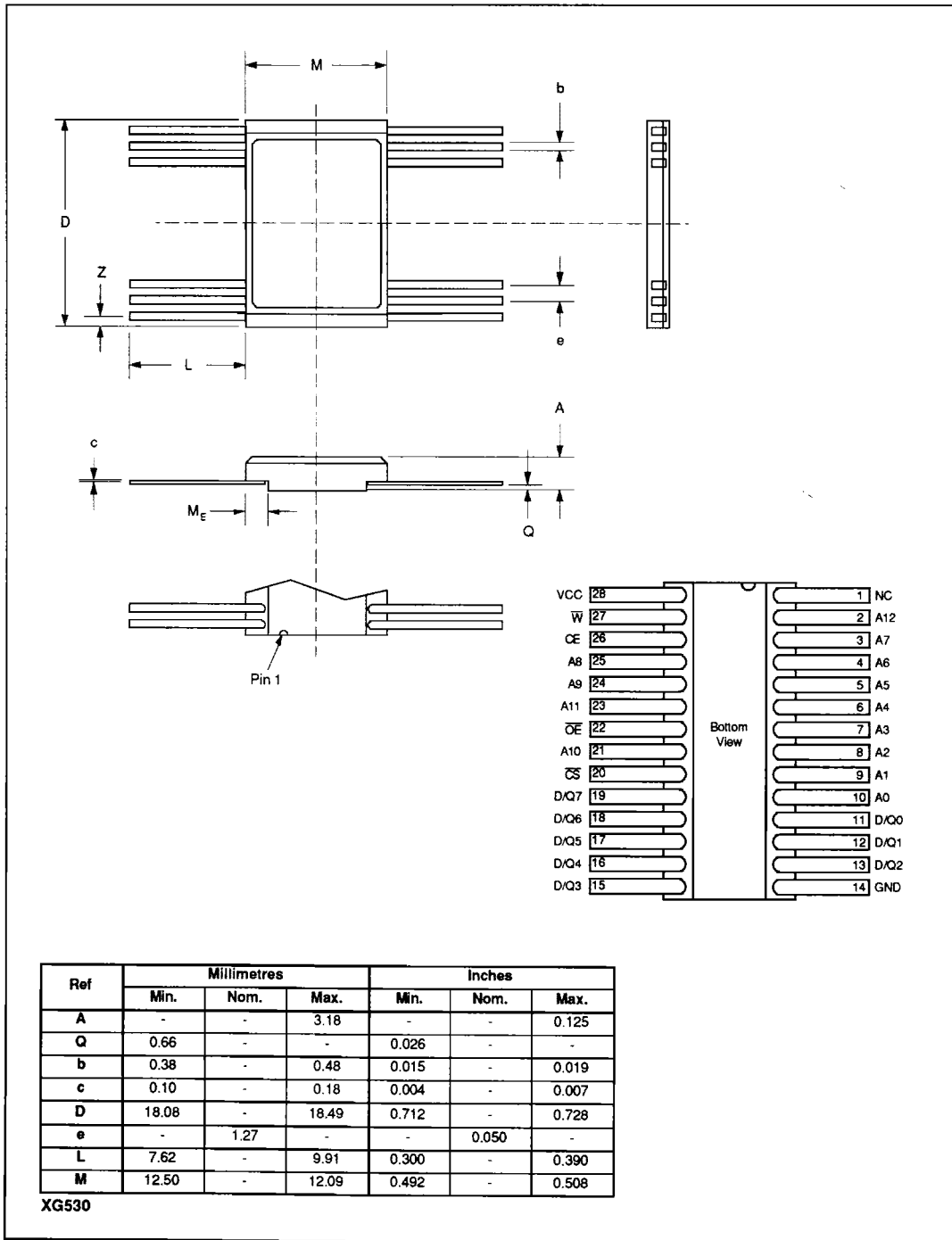

Figure 14: 28-Lead Ceramic Flatpack (Solder Seal) - Package Style F

Function	Pin Number Option D and F	Via	Static 1	Static 2	Dynamic	Radiation
A12	2	R	5V	0V	F14	5V
A7	3	R	5V	0V	F7	5V
A6	4	R	5V	0V	F9	5V
A5	5	R	5V	0V	F8	5V
A4	6	R	5V	0V	F11	5V
A3	7	R	5V	0V	F10	5V
A2	8	R	5V	0V	F5	5V
A1	9	R	5V	0V	F4	5V
A0	10	R	5V	0V	F3	5V
D/Q0	11	R	5V	0V	F1	5V
D/Q1	12	R	5V	0V	F1	5V
D/Q2	13	R	5V	0V	F1	5V
GND(VSS)	14	Direct	0V	0V	0V	0V
D/Q3	15	R	5V	0V	F1	5V
D/Q4	16	R	5V	0V	F1	5V
D/Q5	17	R	5V	0V	F1	5V
D/Q6	18	R	5V	0V	F1	5V
D/Q7	19	R	5V	0V	F1	5V
CSB	20	R	5V	0V	F15	5V
A10	21	R	5V	0V	F2	5V
OEB	22	R	5V	0V	F15	5V
A11	23	R	5V	0V	F6	5V
A9	24	R	5V	0V	F13	5V
A8	25	R	5V	0V	F12	5V
CE	26	R	5V	0V	F15B	5V
WB	27	R	5V	0V	F0	5V
VDD	28	Direct	5V	5V	5V	5V

1. F0 = 150 KHz, F1 = F0/2, F2 = F0/4, F3 = F0/8 etc.
2. Static 1, Static 2 and Dynamic; R = 4k7
3. Radiation; R = 10k

Figure 15: Burnin and Radiation Configuration

**RADIATION TOLERANCE**

**Total Dose Radiation Testing**

For product procured to guaranteed total dose radiation levels, each wafer lot will be approved when all sample devices from each lot pass the total dose radiation test.

The sample devices will be subjected to the total dose radiation level (Cobalt-60 Source), defined by the ordering code, and must continue to meet the electrical parameters specified in the data sheet. Electrical tests, pre and post irradiation, will be read and recorded.

GEC Plessey Semiconductors can provide radiation testing compliant with MIL-STD-883 test method 1019, Ionizing Radiation (Total Dose).

Total Dose (Basic function)	1x10 <sup>6</sup> Rad(Si)
Total Dose (Function to specification)	1x10 <sup>5</sup> Rad(Si)
Transient Upset	>10 <sup>11</sup> Rad(Si)/sec
Neutron Hardness (Function to specification)	>10 <sup>15</sup> neutrons/cm <sup>2</sup>
Single Event Upset (GSO 10% worst case)	4.3x10 <sup>-11</sup> errors/bitday
Latch-up	Not possible

Figure 16: Typical Radiation Hardness Parameters

**SINGLE EVENT UPSET CHARACTERISTICS**

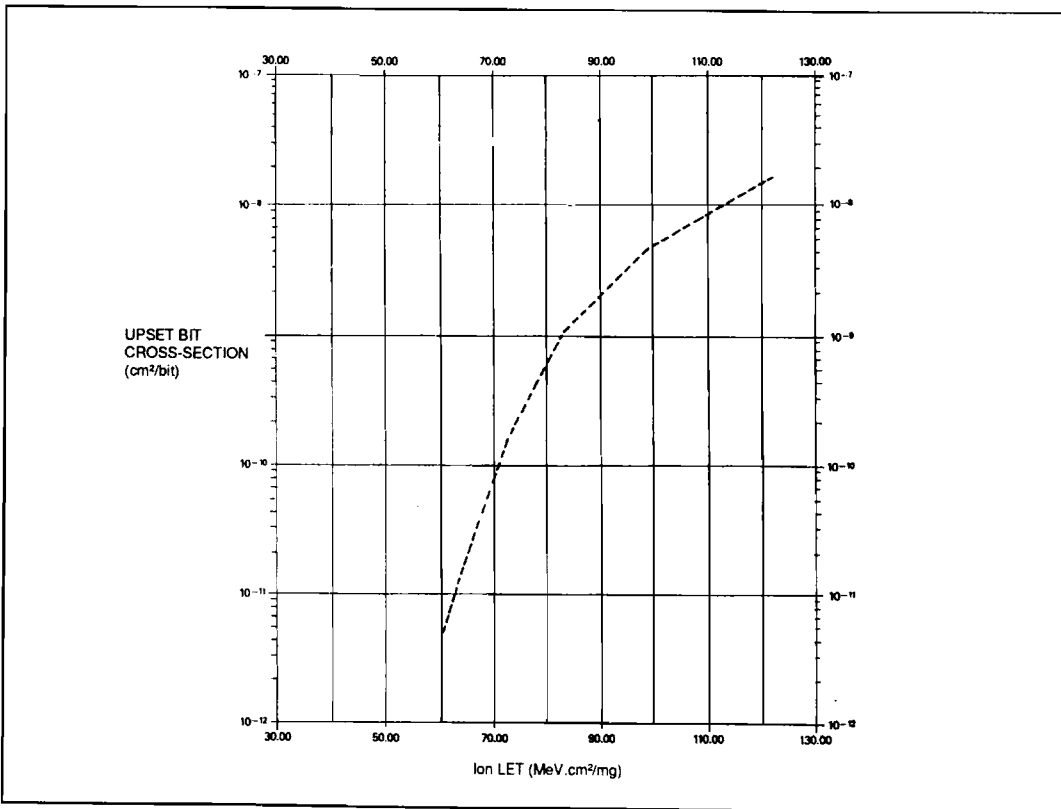

Figure 17: Typical Per-Bit Upset Cross-Section vs Ion LET

**ORDERING INFORMATION**

