

PRODUCT SPECIFICATION

DATE : 05/21/2007

cosmo ELECTRONICS CORPORATION	Power Photo TRIAC :	62P46003	REV.
	KTLP3617H	SHEET 1 OF 6	2

Photo Coupler for Power Photo TRIAC Output

● Features

1. Compact dual-in-line package.
2. 600V peak blocking voltage.
3. Isolation voltage between input and output 5000Vrms.

● Application :

1. TRIAC Driver.
2. Programmable Controllers.
3. AC-Output Module.
4. Solid State Relay.

PRODUCT SPECIFICATION

DATE : 05/21/2007

cosmo ELECTRONICS CORPORATION	Power Photo TRIAC :	62P46003	REV.
	KTLP3617H	SHEET 2 OF 6	2

● Outside dimension : Unit (mm)

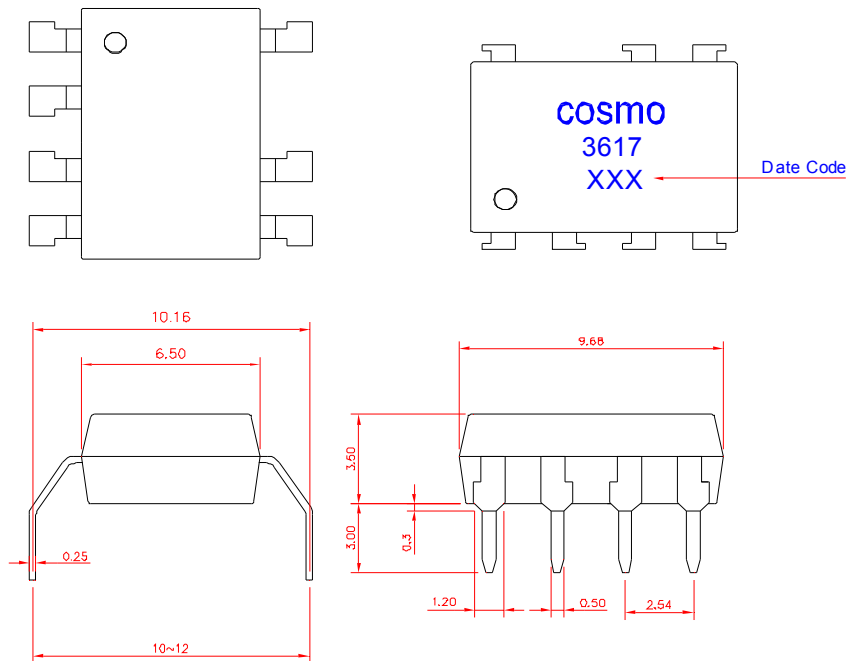

Tolerance : $\pm 0.2\text{mm}$

● Schematic : Top View

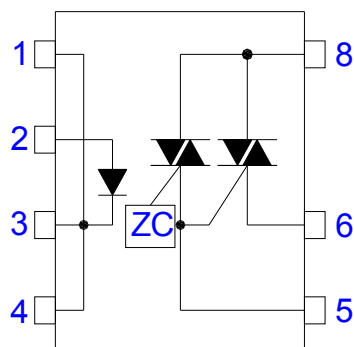

1. Cathode
2. Anode
3. Cathode
4. Cathode
5. Gate
6. T1
8. T2

PRODUCT SPECIFICATION

DATE : 05/21/2007

cosmo ELECTRONICS CORPORATION	Power Photo TRIAC :	62P46003	REV. 2
	KTLP3617H	SHEET 3 OF 6	

● Absolute Maximum Ratings

Parameter		Symbol	Rating	Unit
Input	Forward current	I_F	50	mA
	Peak forward current	I_{FP}	1	A
	Reverse voltage	V_R	6	V
Output	Off-State Output Terminal voltage	V_{DRM}	600	V
	On-State R.M.S. Current	$I_{T(RMS)}$	1.2	A
	Peak Nonrepetitive Surge Current (60Hz, Peak)	I_{TSM}	10	A
Isolation voltage (AC, 1 minute)		V_{iso}	5000	V_{rms}
Operating temperature		T_{opr}	-40 to +85	°C
Storage temperature		T_{stg}	-40 to +125	°C
Soldering temperature 10 second		T_{sol}	260	°C

● Electro-optical Characteristics

Parameter		Symbol	Conditions	MIN.	TYP.	MAX.	Unit
Input	Forward voltage	V_F	$I_F = 10mA$	-	1.2	1.4	V
	Reverse current	I_R	$V_R = 6V$	-	-	10	μA
Output	Peak Blocking Current	I_{DRM}	$V_{DRM} = \text{Rated}$	-	-	100	μA
	On-State Voltage	V_{TM}	$I_T = 1.2A$	-	-	3	V
	Holding Current	I_H	$V_D = 5V$	-	-	25	mA
	Critical rate of rise of Off-state voltage	dV/dt	$V_{DRM} = (1/\sqrt{2}) \cdot \text{Rated}$	-	1000	-	V/ μs
Transfer characteristics	Inhibit voltage (MT1-MT2 Voltage above which device not trigger)	V_{INH}	$I_F = \text{Rated } I_{FT}$	-	-	50	V
	Leakage in Inhibited State	I_{DRM2}	$I_F = \text{Rated } I_{FT}, \text{ Rated } V_{DRM}, \text{ Off State}$	-	200	-	μA
	Isolation resistance	R_{iso}	DC500V	5×10^{10}	-	-	Ω
	Minimum trigger current	I_{FT}	$V_D = 5V$	-	-	10	mA

PRODUCT SPECIFICATION

DATE : 05/21/2007

cosmo
ELECTRONICS CORPORATION

Power Photo TRIAC :
KTLP3617H

62P46003
SHEET 4 OF 6

REV.
2

I_F VS. T_a

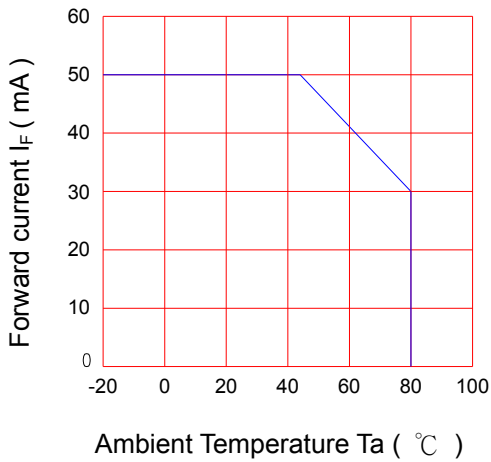

I_T VS. T_a

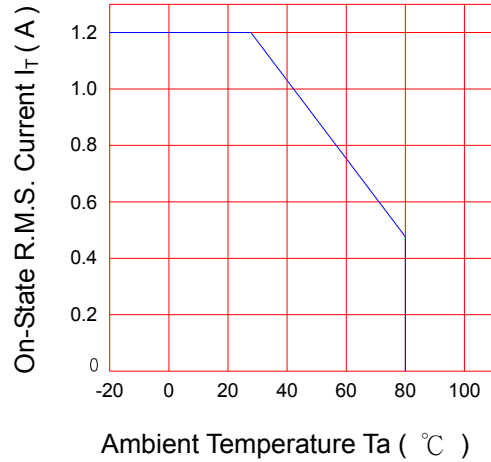

I_{FP} VS. Duty Ratio

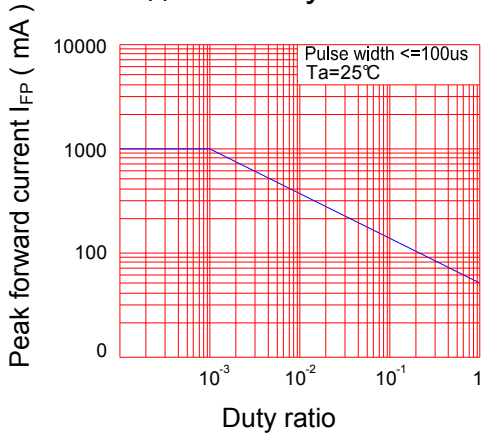

I_F VS. V_F

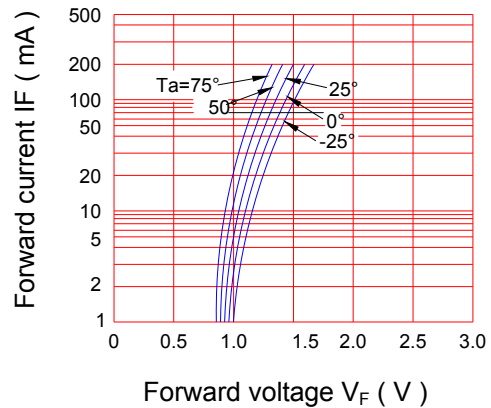

I_{FT} VS. T_a

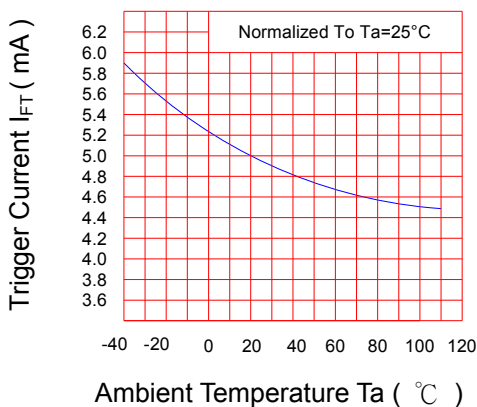

V_{INH} VS. T_a

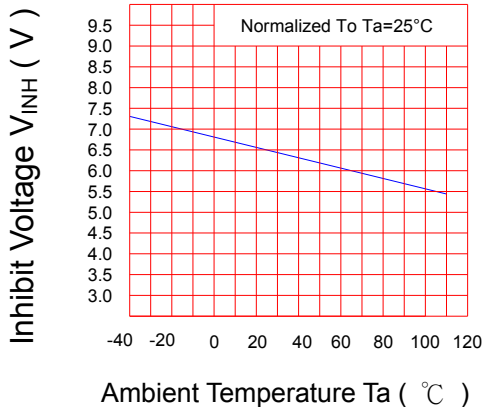

PRODUCT SPECIFICATION

DATE : 05/21/2007

cosmo ELECTRONICS CORPORATION	Power Photo TRIAC : KTLP3617H	62P46003	REV. 2
		SHEET 5 OF 6	

I_{TM} VS. V_{TM}

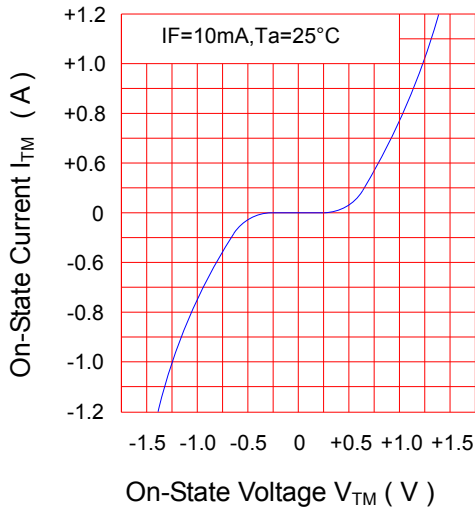

I_{DRM} VS. T_a

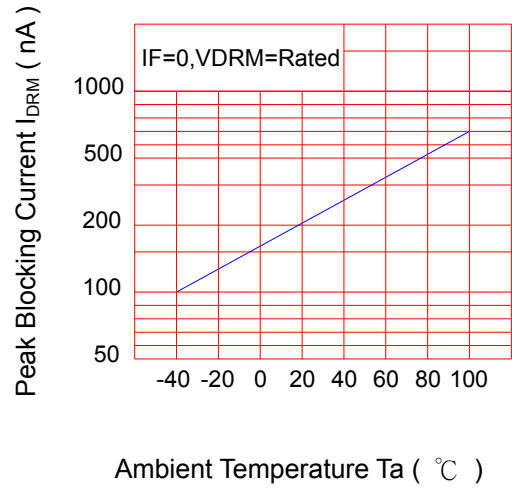

PRODUCT SPECIFICATION

DATE : 05/21/2007

cosmo ELECTRONICS CORPORATION	Power Photo TRIAC :	62P46003	REV.
	KTLP3617H	SHEET 6 OF 6	2

● NOTICE

The information contained in this document is intended to be a general product description and is subject to change without notice. Please contact cosmo in order to obtain the latest device data sheets before using any cosmo device. cosmo does not assume any responsibility for use of any circuitry described. No circuit patent licenses are implied. This publication is the property of cosmo. No part of this publication may be reproduced or copied in any form or by any means, or transferred to any third party without the prior written consent of cosmo Electronics Corporation.

The devices listed in this document are designed for general applications only in electronic equipment. No devices shall be deployed which require higher level of reliability such as :

- Medical and other life support equipments.
- Space application.
- Telecommunication equipment (trunk lines).
- Nuclear power control equipment.

Unless it received prior written approval from cosmo.

cosmo takes no responsibility for damages arise form the improper usage of our device. Please contact cosmo for further information regarding the above notices.