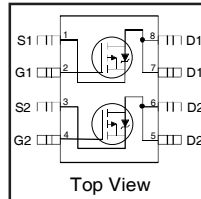


# AUIRF7304Q

## Features

- Advanced Planar Technology
- Low On-Resistance
- Dual P Channel MOSFET
- Dynamic dV/dT Rating
- Logic Level
- 150°C Operating Temperature
- Fast Switching
- Lead-Free, RoHS Compliant
- Automotive Qualified\*

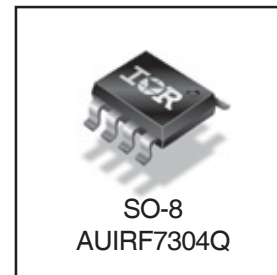


HEXFET® Power MOSFET

$V_{(BR)DSS}$	<b>-20V</b>
$R_{DS(on) \text{ max.}}$	<b>0.090Ω</b>
$I_D$	<b>-4.3A</b>

## Description

Specifically designed for Automotive applications, this cellular design of HEXFET® Power MOSFETs utilizes the latest processing techniques to achieve low on-resistance per silicon area. This benefit combined with the fast switching speed and ruggedized device design that HEXFET power MOSFETs are well known for, provides the designer with an extremely efficient and reliable device for use in Automotive and a wide variety of other applications.



## Absolute Maximum Ratings

Stresses beyond those listed under “Absolute Maximum Ratings” may cause permanent damage to the device. These are stress ratings only; and functional operation of the device at these or any other condition beyond those indicated in the specifications is not implied. Exposure to absolute-maximum-rated conditions for extended periods may affect device reliability. The thermal resistance and power dissipation ratings are measured under board mounted and still air conditions. Ambient temperature ( $T_A$ ) is 25°C, unless otherwise specified.

	Parameter	Max.	Units
$I_D @ T_A = 25^\circ\text{C}$	10 Sec. Pulsed Drain Current, $V_{GS} @ -4.5\text{V}$	-4.7	A
$I_D @ T_A = 25^\circ\text{C}$	Continuous Drain Current, $V_{GS} @ -4.5\text{V}$	-4.3	
$I_D @ T_A = 70^\circ\text{C}$	Continuous Drain Current, $V_{GS} @ -4.5\text{V}$	-3.4	
$I_{DM}$	Pulsed Drain Current ①	-17	
$P_D @ T_A = 25^\circ\text{C}$	Power Dissipation ②	2.0	W
	Linear Derating Factor	0.016	W/°C
$V_{GS}$	Gate-to-Source Voltage	± 12	V
dv/dt	Peak Diode Recovery dv/dt ③	-5.0	V/ns
$T_J$	Operating Junction and	-55 to + 150	°C
$T_{STG}$	Storage Temperature Range		

## Thermal Resistance

	Parameter	Typ.	Max.	Units
$R_{\theta JA}$	Junction-to-Ambient ④ ⑤	—	62.5	°C/W

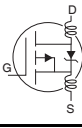
HEXFET® is a registered trademark of International Rectifier.

\*Qualification standards can be found at <http://www.irf.com/>

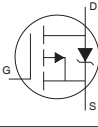
### Static Electrical Characteristics @ $T_J = 25^\circ\text{C}$ (unless otherwise specified)

	Parameter	Min.	Typ.	Max.	Units	Conditions
$V_{(BR)DSS}$	Drain-to-Source Breakdown Voltage	-20	—	—	V	$V_{GS} = 0V, I_D = -250\mu A$
$\Delta V_{(BR)DSS}/\Delta T_J$	Breakdown Voltage Temp. Coefficient	—	-0.012	—	V/°C	Reference to $25^\circ\text{C}$ , $I_D = -1mA$
$R_{DS(on)}$	Static Drain-to-Source On-Resistance	—	—	0.090	$\Omega$	$V_{GS} = -4.5V, I_D = -2.2A$ ③
		—	—	0.140		$V_{GS} = -2.7V, I_D = -1.8A$ ③
$V_{GS(th)}$	Gate Threshold Voltage	-0.70	—	-1.5	V	$V_{DS} = V_{GS}, I_D = -250\mu A$
$g_{fs}$	Forward Transconductance	4.0	—	—	S	$V_{DS} = -16V, I_D = -2.2A$
$I_{DSS}$	Drain-to-Source Leakage Current	—	—	-1.0	$\mu A$	$V_{DS} = -16V, V_{GS} = 0V$
		—	—	-25		$V_{DS} = -16V, V_{GS} = 0V, T_J = 125^\circ\text{C}$
$I_{GSS}$	Gate-to-Source Forward Leakage	—	—	-100	nA	$V_{GS} = -12V$
	Gate-to-Source Reverse Leakage	—	—	100		$V_{GS} = 12V$

### Dynamic Electrical Characteristics @ $T_J = 25^\circ\text{C}$ (unless otherwise specified)

	Parameter	Min.	Typ.	Max.	Units	Conditions
$Q_g$	Total Gate Charge	—	—	22	nC	$I_D = -2.2A$
$Q_{gs}$	Gate-to-Source Charge	—	—	3.3		$V_{DS} = -16V$
$Q_{gd}$	Gate-to-Drain ("Miller") Charge	—	—	9.0		$V_{GS} = -4.5V$ , See Fig. 6 & 12 ③
$t_{d(on)}$	Turn-On Delay Time	—	8.4	—	ns	$V_{DD} = -10V$
$t_r$	Rise Time	—	26	—		$I_D = -2.2A$
$t_{d(off)}$	Turn-Off Delay Time	—	51	—		$R_G = 6.0\Omega$
$t_f$	Fall Time	—	33	—		$R_D = 4.5\Omega$ , See Fig. 10 ③
$L_D$	Internal Drain Inductance	—	4.0	—	nH	Between lead, 6mm (0.25in.) from package and center of die contact
$L_S$	Internal Source Inductance	—	6.0	—		
$C_{iss}$	Input Capacitance	—	610	—	pF	$V_{GS} = 0V$
$C_{oss}$	Output Capacitance	—	310	—		$V_{DS} = -15V$
$C_{rss}$	Reverse Transfer Capacitance	—	170	—		$f = 1.0MHz$ , See Fig. 5

### Diode Characteristics

	Parameter	Min.	Typ.	Max.	Units	Conditions
$I_S$	Continuous Source Current (Body Diode)	—	—	-2.5	A	MOSFET symbol showing the integral reverse p-n junction diode. 
$I_{SM}$	Pulsed Source Current (Body Diode) ①	—	—	-17		
$V_{SD}$	Diode Forward Voltage	—	—	-1.0	V	$T_J = 25^\circ\text{C}, I_S = -1.8A, V_{GS} = 0V$ ③
$t_{rr}$	Reverse Recovery Time	—	56	84	ns	$T_J = 25^\circ\text{C}, I_F = -2.2A$
$Q_{rr}$	Reverse Recovery Charge	—	71	110	nC	$di/dt = 100A/\mu s$ ③
$t_{on}$	Forward Turn-On Time	Intrinsic turn-on time is negligible (turn-on is dominated by $L_S+L_D$ )				

#### Notes:

- ① Repetitive rating; pulse width limited by max. junction temperature. ( See fig. 11 )
- ②  $I_{SD} \leq -2.2A, di/dt \leq -50A/\mu s, V_{DD} \leq V_{(BR)DSS}, T_J \leq 150^\circ\text{C}$ .
- ③ Pulse width  $\leq 300\mu s$ ; duty cycle  $\leq 2\%$ .
- ④ Starting  $T_J = 25^\circ\text{C}, R_G = 25\Omega, I_{AS} = -2.2A$ .
- ⑤ When mounted on 1 inch square copper board,  $t < 10$  sec.

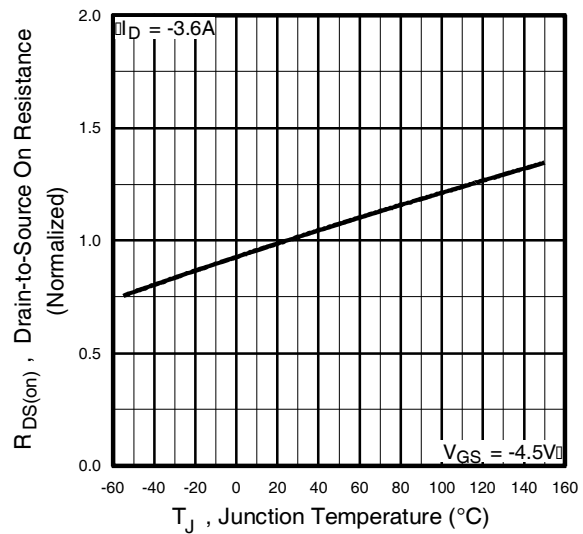
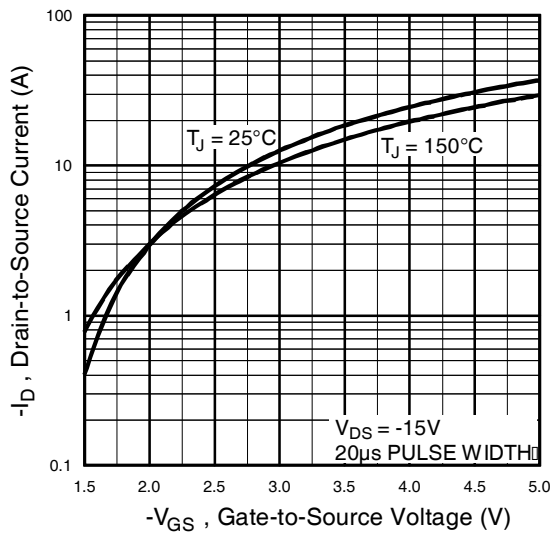
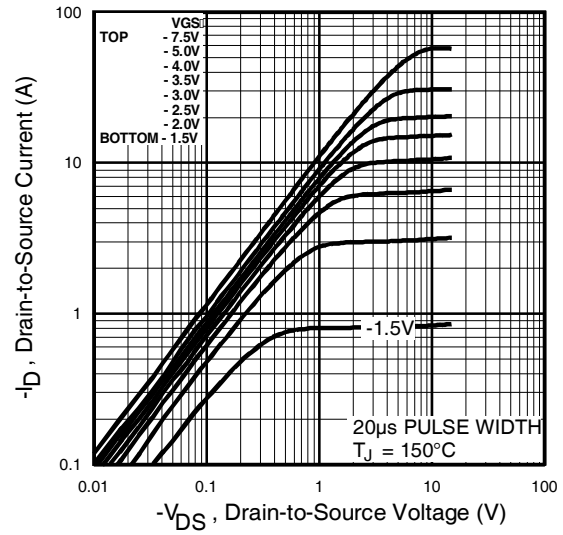
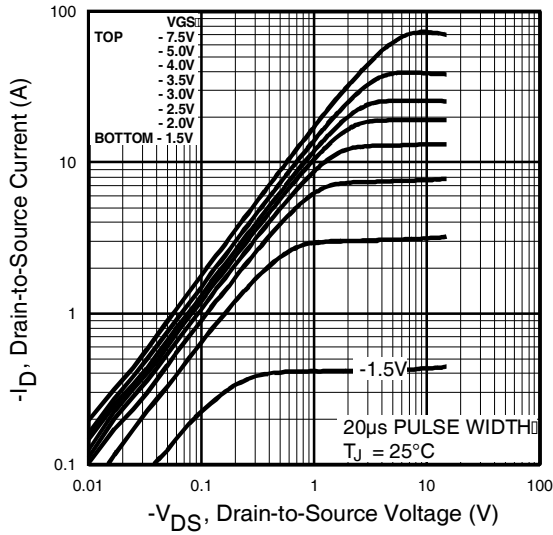
## Qualification Information<sup>†</sup>

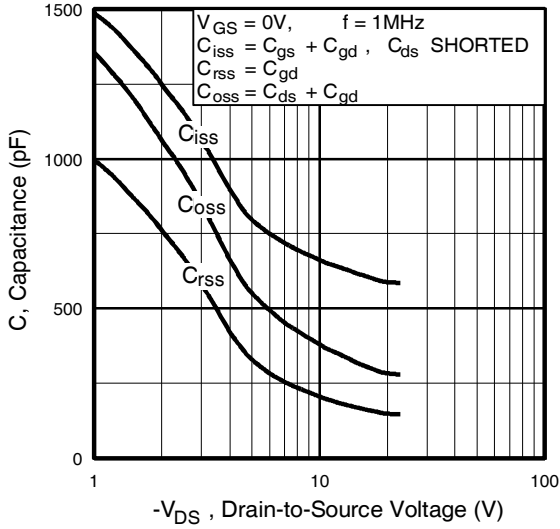
<b>Qualification Level</b>		Automotive (per AEC-Q101) <sup>††</sup>	
		Comments: This part number(s) passed Automotive qualification. IR's Industrial and Consumer qualification level is granted by extension of the higher Automotive level.	
<b>Moisture Sensitivity Level</b>		SO-8	MSL1
<b>ESD</b>	Machine Model	Class M1B (+/- 100V) <sup>†††</sup> AEC-Q101-002	
	Human Body Model	Class H0 (+/- 250V) <sup>†††</sup> AEC-Q101-001	
	Charged Device Model	Class C5 (+/- 2000V) <sup>†††</sup> AEC-Q101-005	
<b>RoHS Compliant</b>		Yes	

† Qualification standards can be found at International Rectifier's web site: <http://www.irf.com/>

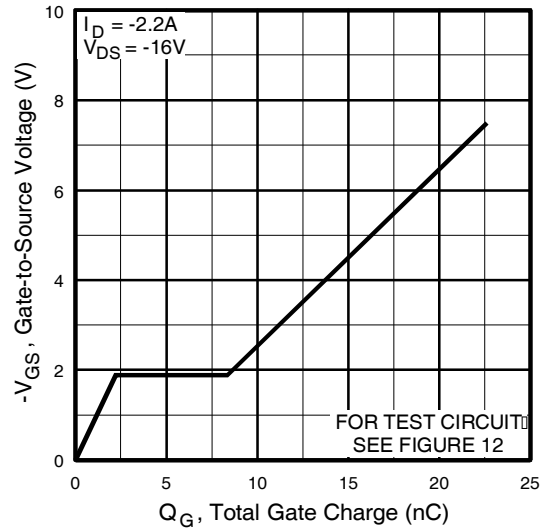
†† Exceptions to AEC-Q101 requirements are noted in the qualification report.

††† Highest passing voltage.

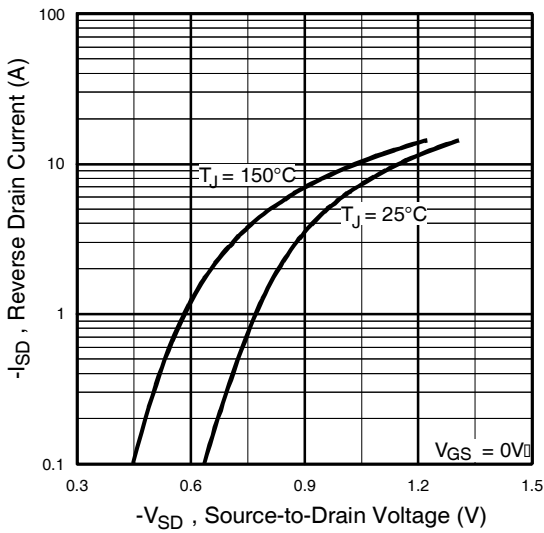




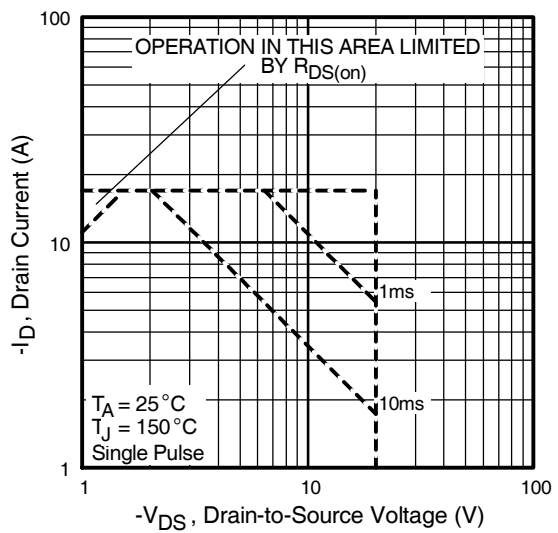
**Fig 5.** Typical Capacitance Vs. Drain-to-Source Voltage



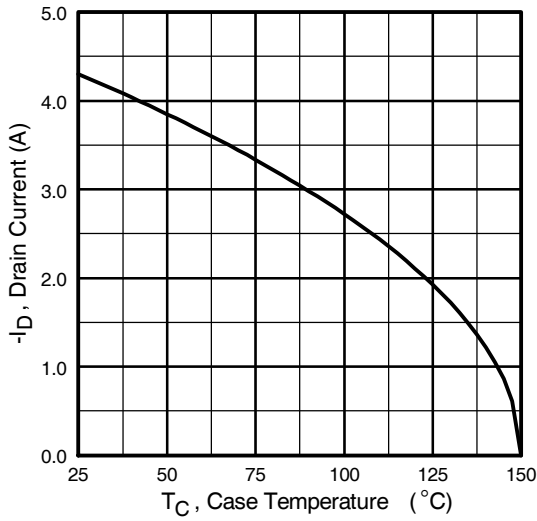
**Fig 6.** Typical Gate Charge Vs. Gate-to-Source Voltage



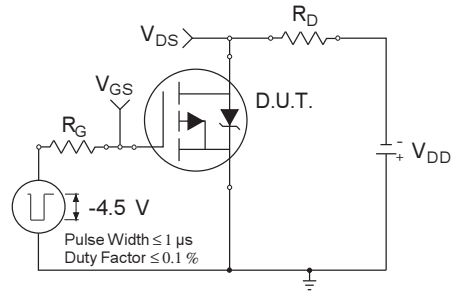
**Fig 7.** Typical Source-Drain Diode Forward Voltage



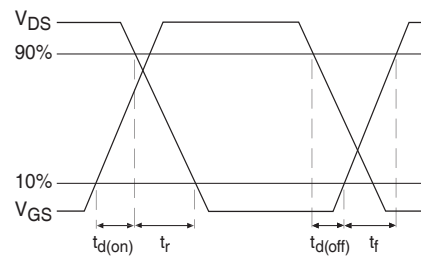
**Fig 8.** Maximum Safe Operating Area



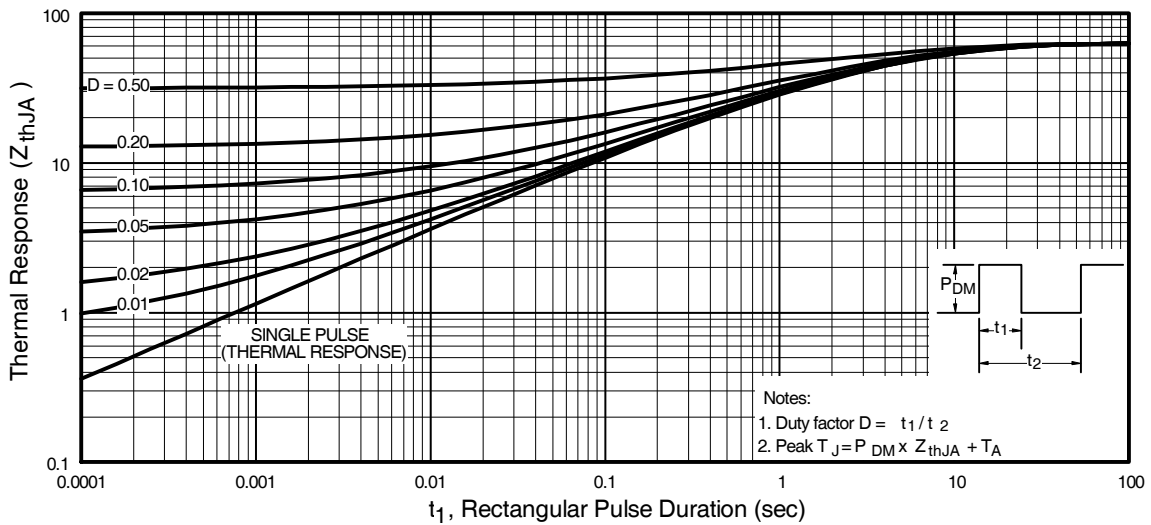
**Fig 9.** Maximum Drain Current Vs. Ambient Temperature



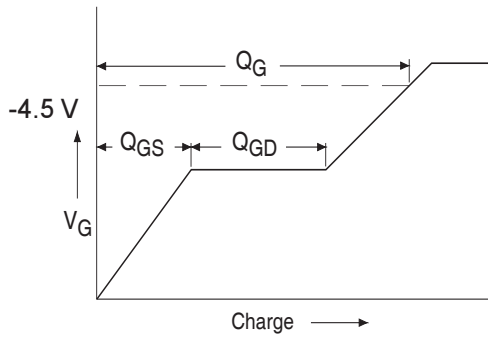
**Fig 10a.** Switching Time Test Circuit



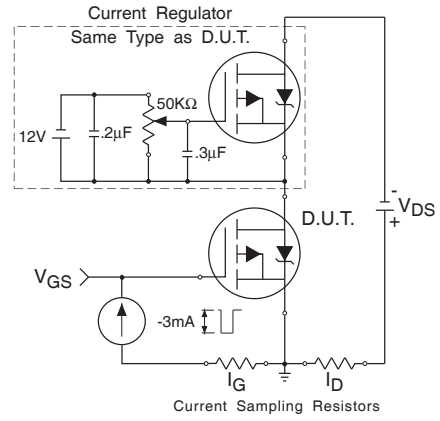
**Fig 10b.** Switching Time Waveforms



**Fig 11.** Maximum Effective Transient Thermal Impedance, Junction-to-Ambient

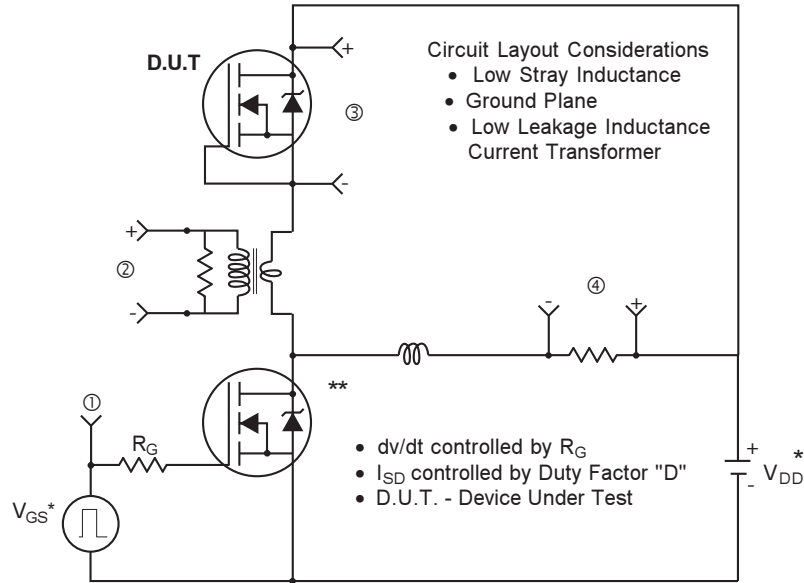


**Fig 12a.** Basic Gate Charge Waveform



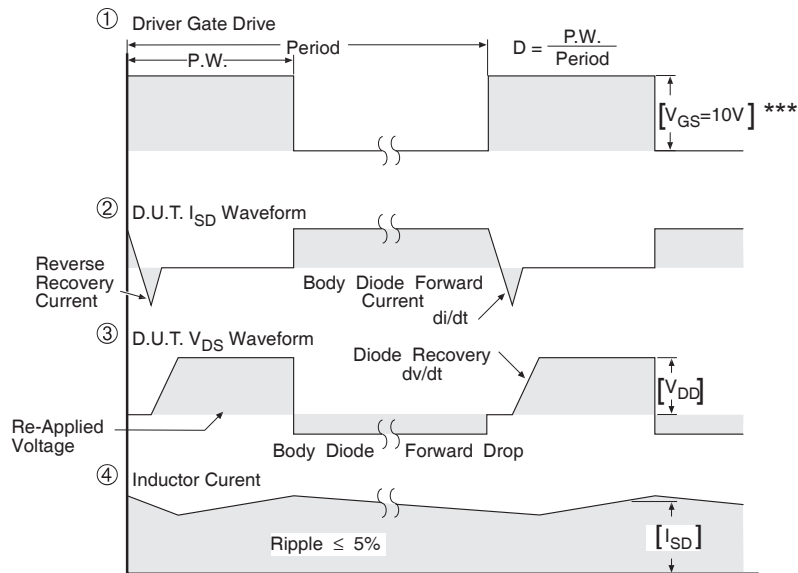
**Fig 12b.** Gate Charge Test Circuit

## Peak Diode Recovery dv/dt Test Circuit



\* Reverse Polarity for P-Channel

\*\* Use P-Channel Driver for P-Channel Measurements



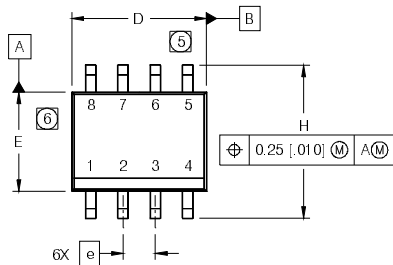
\*\*\*  $V_{GS} = 5.0V$  for Logic Level and 3V Drive Devices

**Fig 13.** For P-Channel HEXFETS

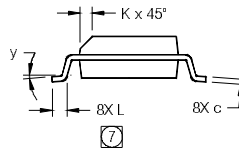
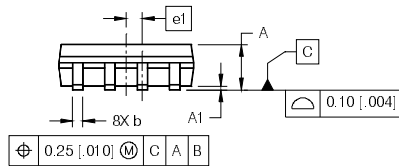


## SO-8 Package Outline

Dimensions are shown in millimeters (inches)



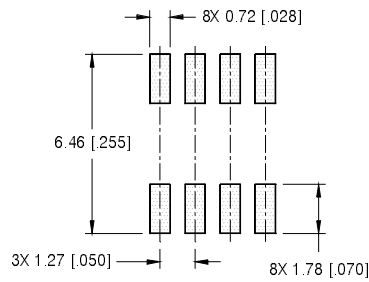
DIM	INCHES		MILLIMETERS	
	MIN	MAX	MIN	MAX
A	.0532	.0688	1.35	1.75
A1	.0040	.0098	0.10	0.25
b	.013	.020	0.33	0.51
c	.0075	.0098	0.19	0.25
D	.189	.1968	4.80	5.00
E	.1497	.1574	3.80	4.00
e	.050 BASIC		1.27 BASIC	
e1	.025 BASIC		0.635 BASIC	
H	.2284	.2440	5.80	6.20
K	.0099	.0196	0.25	0.50
L	.016	.050	0.40	1.27
y	0°	8°	0°	8°



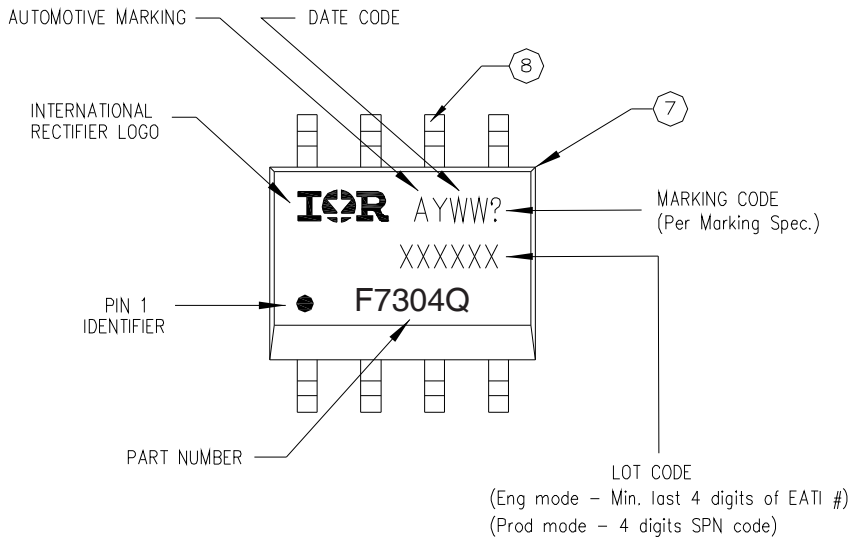
**NOTES:**

1. DIMENSIONING & TOLERANCING PER ASME Y14.5M-1994.
2. CONTROLLING DIMENSION: MILLIMETER
3. DIMENSIONS ARE SHOWN IN MILLIMETERS [INCHES].
4. OUTLINE CONFORMS TO JEDEC OUTLINE MS-012AA.
- ⑤ DIMENSION DOES NOT INCLUDE MOLD PROTRUSIONS. MOLD PROTRUSIONS NOT TO EXCEED 0.15 [0.006].
- ⑥ DIMENSION DOES NOT INCLUDE MOLD PROTRUSIONS. MOLD PROTRUSIONS NOT TO EXCEED 0.25 [0.010].
- ⑦ DIMENSION IS THE LENGTH OF LEAD FOR SOLDERING TO A SUBSTRATE.

**FOOTPRINT**



## SO-8 Part Marking

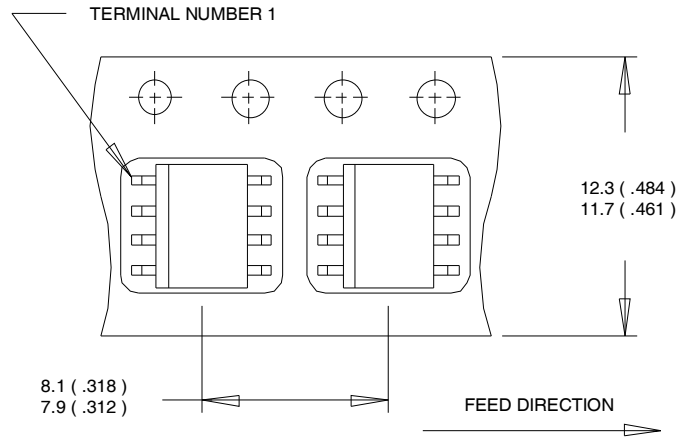


Note: For the most current drawing please refer to IR website at <http://www.irf.com/package/>

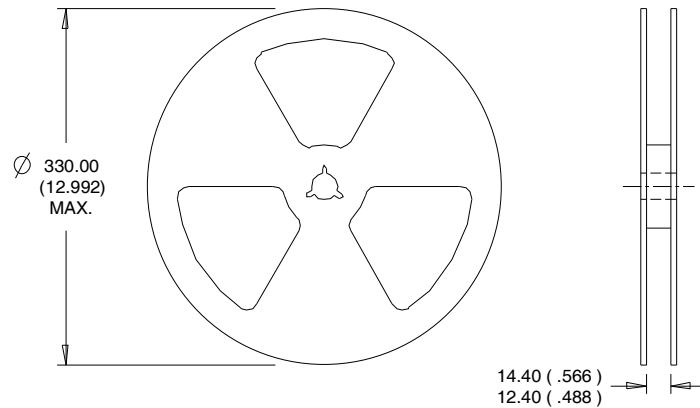
# AUIRF7304Q

## SO-8 Tape and Reel

Dimensions are shown in millimeters (inches)



- NOTES:
1. CONTROLLING DIMENSION : MILLIMETER.
  2. ALL DIMENSIONS ARE SHOWN IN MILLIMETERS(INCHES).
  3. OUTLINE CONFORMS TO EIA-481 & EIA-541.



- NOTES:
1. CONTROLLING DIMENSION : MILLIMETER.
  2. OUTLINE CONFORMS TO EIA-481 & EIA-541.

## Ordering Information

Base part number	Package Type	Standard Pack		Complete Part Number
		Form	Quantity	
AUIRF7304Q	SO-8	Tube	95	AUIRF7304Q
		Tape and Reel	2500	AUIRF7304QTR

## IMPORTANT NOTICE

Unless specifically designated for the automotive market, International Rectifier Corporation and its subsidiaries (IR) reserve the right to make corrections, modifications, enhancements, improvements, and other changes to its products and services at any time and to discontinue any product or services without notice. Part numbers designated with the "AU" prefix follow automotive industry and / or customer specific requirements with regards to product discontinuance and process change notification. All products are sold subject to IR's terms and conditions of sale supplied at the time of order acknowledgment.

IR warrants performance of its hardware products to the specifications applicable at the time of sale in accordance with IR's standard warranty. Testing and other quality control techniques are used to the extent IR deems necessary to support this warranty. Except where mandated by government requirements, testing of all parameters of each product is not necessarily performed.

IR assumes no liability for applications assistance or customer product design. Customers are responsible for their products and applications using IR components. To minimize the risks with customer products and applications, customers should provide adequate design and operating safeguards.

Reproduction of IR information in IR data books or data sheets is permissible only if reproduction is without alteration and is accompanied by all associated warranties, conditions, limitations, and notices. Reproduction of this information with alterations is an unfair and deceptive business practice. IR is not responsible or liable for such altered documentation. Information of third parties may be subject to additional restrictions.

Resale of IR products or serviced with statements different from or beyond the parameters stated by IR for that product or service voids all express and any implied warranties for the associated IR product or service and is an unfair and deceptive business practice. IR is not responsible or liable for any such statements.

IR products are not designed, intended, or authorized for use as components in systems intended for surgical implant into the body, or in other applications intended to support or sustain life, or in any other application in which the failure of the IR product could create a situation where personal injury or death may occur. Should Buyer purchase or use IR products for any such unintended or unauthorized application, Buyer shall indemnify and hold International Rectifier and its officers, employees, subsidiaries, affiliates, and distributors harmless against all claims, costs, damages, and expenses, and reasonable attorney fees arising out of, directly or indirectly, any claim of personal injury or death associated with such unintended or unauthorized use, even if such claim alleges that IR was negligent regarding the design or manufacture of the product.

IR products are neither designed nor intended for use in military/aerospace applications or environments unless the IR products are specifically designated by IR as military-grade or "enhanced plastic." Only products designated by IR as military-grade meet military specifications. Buyers acknowledge and agree that any such use of IR products which IR has not designated as military-grade is solely at the Buyer's risk, and that they are solely responsible for compliance with all legal and regulatory requirements in connection with such use.

IR products are neither designed nor intended for use in automotive applications or environments unless the specific IR products are designated by IR as compliant with ISO/TS 16949 requirements and bear a part number including the designation "AU". Buyers acknowledge and agree that, if they use any non-designated products in automotive applications, IR will not be responsible for any failure to meet such requirements.

For technical support, please contact IR's Technical Assistance Center  
<http://www.irf.com/technical-info/>

**WORLD HEADQUARTERS:**  
101 N. Sepulveda Blvd., El Segundo, California 90245  
Tel: (310) 252-7105